



Quality tools. Traditional brands since 1839.



Divisions of

WÄNGBES



since 1878



since 1952



since 1839



Johann Dönges begann 1903 in Remscheid mit der Produktion von Feilen und Raspeln.

Der Verkauf erfolgte zunächst hauptsächlich in Remscheid und Solingen. In den 20er-Jahren dehnte sich der Kundenkreis immer weiter aus.

Im Sommer 1949 trat **Heinrich Dönges**, der Sohn des Inhabers, in die Firma ein. Er baute

ein Programm mit Qualitätswerkzeugen parallel zur Feilenfertigung auf.

Nach dem Tode von Johann Dönges im Jahre 1962 wurde die Feilenproduktion im Jahre 1967 eingestellt. 1971 wurde **Marion Pletsch**, die Enkelin des Gründers, Inhaberin.

In jener Zeit wurde das Geschäft mit den Bundesbehörden aufgebaut. Aus diesen Bereichen entstanden später auch weitere Standbeine, wie Feuerwehrausrüstung und Kriminaltechnik.

Dönges – über 110 Jahre aktiv

Viele Spezialartikel werden heute exklusiv von uns hergestellt. Der Standort Remscheid, als ein Zentrum der deutschen Werkzeugindustrie, unterstützt bis heute unsere Arbeit in besonderem Maße.

2010/2011 wurde das Bürogebäude aufgestockt und die Lagerfläche durch ein modernes Hochregallager erweitert. Auf über 5.000 m² sind wir damit bestens gerüstet, um unseren Kunden auch in der Zukunft schnell und effizient unseren umfangreichen Service zu bieten.

Johann Dönges started to manufacture files and rasps in Remscheid in 1903. The majority of the products were initially sold in Remscheid and Solingen. The customer base expanded continuously in the 1920's.

The owner's son, **Heinrich Dönges**, joined the company in 1949. He built up a range of quality tools whilst continuing to manufacture files. Johann Dönges died in 1962, and eventually the file production was stopped in 1967. **Marion Pletsch**, the founder's granddaughter, took over the company in 1971.

In those years, we built up our business with federal authorities. This range also developed our business with fire rescue service and police.



Dönges – more than 110 years

Meanwhile we produce a lot of specialties exclusively. To date, Remscheid as the center of Germany's tool industry notably supports our work.

2010/2011 we added another storey to the office building and enlarged our storage space with a modern high rack storage area. With over 5.000 m², we are best prepared to offer our customers a prompt and efficient service as usual.





since 1878



since 1952



since 1839

Vor einigen Jahren haben wir nach und nach die Traditions-
marken für Handwerkzeuge übernommen und setzen
hier eine fast 200-jährige Linie an deutschen Qualitäts-
werkzeugen fort.

In den Händen halten Sie unseren neuen Katalog
Quality tools. Traditional brands since 1839.

Auf über 360 Seiten finden Sie unser ständig wachsendes
Programm an professionellen und innovativen Produkten
für das Handwerk.

Sprechen Sie uns an, wenn Sie Fragen, Anregungen und
Kritik haben - wir sind immer ganz für Sie da.

Generell freuen wir uns immer über Ihren Anruf - natür-
lich auch bei allen technischen Rückfragen.

Wir freuen uns auf eine gute, partnerschaftliche
Zusammenarbeit ...

The last few years, we have gradually taken over, almost
all the traditional brands in Hand Tools and we like to
continue an almost 200 years traditional line in german
quality hand tools.

We are proud to present to you, our new catalogue
Quality tools traditional brands since 1839.

Our catalogue is made up of over 360 pages, where you
can always find our updated delivery programme on
professional and innovative products, both for the pro-
fessionals and homeworkers.

Please do not hesitate to contact us, if you have ques-
tions, suggestions and comments. We are always at your
disposal. In general, we are always pleased to hear from
you - especially if you require our technical advice.

We are looking forward to a good and fruitful
co-operation ...

Wilfried Funk

Exportleiter Handel/Export Manager

Phone +49(0)21 91/56 26-170
Mobile +49(0)171/56 32 38 3
Fax +49(0)21 91/56 26 26-170
Mail wf@doenges-rs.de

Alexander Hintze

Export Manager

Phone +49(0)21 91/56 26-172
Mobile +49(0)171/56 32 38 2
Fax +49(0)21 91/56 26 26-172
Mail alh@doenges-rs.de

Christopher Hohn

Export Innendienst/Export office

Phone +49(0)21 91/56 26-168
Fax +49(0)21 91/56 26 26-168
Mail ch@doenges-rs.de



Damit unsere Ware Sie so schnell wie möglich erreicht, setzen wir auf moderne Lagertechnik. Die Artikel lagern in unserem Hochregallager mit 4.200 m² Fläche und über 3.000 Palettenplätzen.

Mittels belegloser, wegeoptimierter Scanner- Kommissionierung, einer vollautomatischen Packstraße und Spezialflurfördergeräten sorgen wir für kürzeste Durchlaufzeiten und einen zügigen Versand.



In order to cut down our delivery time, we have installed a very modern storage system.

We have in stock a large selection of goods from our delivery programme, in an area of about 4.200 m², along with high bay racking system and space for over 3.000 pallets.

We do business in many countries, all over the world and our packing system can match the special requirements of the various countries.

We deliver our Hand-Tools Made in Germany with our famous brands all over the world.



Es ist für uns äußerst entscheidend, dass Sie mit der Qualität unserer Produkte zufrieden sind.

Wir legen daher für unser komplettes Programm höchsten Wert auf Qualität und Verarbeitung.

In unserer konsequent kundenorientierten Ausrichtung haben wir 2009 mit der Einführung eines Qualitätsmanagementsystems nach den Anforderungen der DIN EN ISO 9001:2008 einen weiteren Schritt vorwärts getan.

PDFs der Zertifizierungsurkunden stehen auf unserer Homepage zur Einsicht bzw. zum Download bereit.

Your satisfaction with the quality of our products is extremely important to us.

We therefore put great value on quality and workman-ship in our entire product range.

Another step in our consistently customer-oriented direction was taken 2009 with the introduction of a quality management system in compliance with the requirements of DIN EN ISO 9001:2008.

PDF's of the certification documents can be inspected or downloaded on our home page.





Feuerwehrausrüstung

In nur wenigen Jahren haben wir es in diesem Bereich zum Marktführer geschafft - unsere Produkte finden sich inzwischen auf jedem Feuerwehrfahrzeug.

Fire service equipment

In just a few years we have established ourselves as the market leader in this area - our products can now be found in every fire service vehicle.



Funkenfreie Werkzeuge

Diese Werkzeuge werden überall dort eingesetzt, wo Funken eine potentielle Feuer- und Explosionsgefahr bedeuten. Spezialprogramm mit über 1.000 Artikeln.

Non-sparking tools

These tools are used everywhere, where sparks are a potential risk of fire and explosions. Special product range containing more than 1,000 items.



Elektronik-Werkzeuge

Über unsere Schwester Wetec bedienen wir die Elektronik-Industrie mit einem einzigartigen Programm: Elektronikwerkzeuge, Löttechnik, Lötmaterial & ESD-Produkte.

Electronic tools

Via our sister company Wetec we deal with the electronics industry with an unique product range: Electronic tools, soldering systems, solder and ESD products.



Sanitär/Zangen
Sanitary/Pliers

21



Schneidwerkzeuge	18-30	Cutting tools	18-30
Prüf-/Montagewerkzeuge	22-39	Test-/fitting tools	22-39
Zangen	27-50	Pliers	27-50
Reinigung	35-36	Cleaning	35-36
Loch- und Stanzwerkzeug	50-55	Punch-/pressing tools	55-55

Schraubendreher/Elektro
Screwdriver/Electro

22



Schraubwerkzeuge	58-99	Screwing tools	58-99
Spannungstester	65-69	Voltage/Power Testers	65-69
Elektrobedarf	70-78	Electro demand	70-78

Automobil/Werkstatt
Automobile/Workshop

23



Radwechsel	102-121	Tyre exchange	102-121
Motorwartung	103-106	Engine maintenance	103-106
Hämmer	106-117	Hammers	106-117
Schlüssel	108-113	Spanners	108-113
Ratschen/Steckschlüssel	103-116	Ratchets/Sockets	103-116

Gewindebearbeitung
Thread Work Tools

24



Schneidwerkzeuge	124-126	Cutting Tools	124-126
Anwendungswerkzeuge	125-129	Applications	125-129
Sätze	129	Sets	129

Messen/Ausrichten
Measuring/Adjustment

25



Längenmessung	132-141	Lengthmeasuring	132-141
Winkel-/Gradmessung	134-139	Angle/degree measuring	134-139
Durchmesser/Umfang	141-149	Diameter/circumference	141-149
Stärke/Abstand	143-149	Strength/distance	143-149

Holz-/Metall-/Metzgerbedarf
Wood-/Metal-/Meatworking

26



Sägen/Sägearbeiten	153-172	Saws/Fret working	153-172
Metzgereibedarf	157-160	Butcher's demand	157-160
Feilen	173-179	Files	173-179
Bearbeitungswerkzeuge	152-180	Applications	152-180



Bohr-/Meißelwerkzeuge
Drill-/Chisel tools

27



Steinbearbeitung	184-191	Stone working	184-191
Metallbearbeitung	192-202	Metal working	192-202
Holzbearbeitung	197-217	Wood working	197-217

Baubedarf
Building material

28



Fliesen	222-228	Tiles	222-228
Glas	234-241	Glass	234-241
Wandbearbeitung	226-251	Wall	226-251
Duschezubehör	252-259	Shower Accessories	252-259

Allgemeine Bedarfsgüter
General demands

29



Pflege/Polituren	258-260	Polishing	258-260
Befestigung	263-269	Fixing material	263-269
Reinigung	261-264	Cleaning	261-264
Dachdeckerbedarf	273	Roofer's demand	273

Schlosser/Schweißer
Machinist/Welder

30



Scheren	276-283	Shears	276-283
Spannen/Befestigen	282-350	Tensioning/Fixing	282-350
Hämmer	284-289	Hammers	284-289
Schlagwerkzeuge	290-337	Punching tools	290-337
Löten/Schweissen	304-328	Soldering/Welding	304-328
Schleifen/Trennen	329-335	Grinding/Cutting	329-335

Stichsägeblätter/Lochsägen
Hole saws

31



Stichsägeblätter	350-354	Jig saw blades	350-354
Lochsägen	355	Hole saws	355

A		Bremsfederzange	105	Feilen	173-179
Abisolierzange	41, 45	Brustbohrmaschine	203	bürste	175
Abisoliermesser	73-76	Bügel-		heft	175
Adaptersatz	81	gasanzünder	312	satz	175
Aderendhülsenzange	54-55	säge	158	Feilkloben	282-283
Aluminium-		C		Feinmechaniker-	
Auflegebacken	302	Crimpzange	55	Sägebogen	162
Lineal	140	D		Schraubendreher	79-80
Anschlagwinkel	134	Dachdecker-		Feinsäge	156
Arbeitsschutzhelm	343	zangen	49, 273	Fettpresse	342
Armaturenschlüssel	26, 31-32	Nagel/Flickeisen	273	Feuerwehrausrüstung	4
Armaturen-Rohrzange	31	Arbeitskelle	248	Fiberscheibe	331
Astsäge	154	Dämmstoffmesser	230	Fitschenbeitel	168
Aufnahmeschaft für Lochsäge	355	Diagonalschneider	45	Fittingbürste	24
Aufstecksenker	200	DIAMANT-Trennscheibe	332-333	FIT-Scherenzange	45
Aufweitezange	30	Doppelblechlocher	21	Flächenspachtel	241-245
Ausbeulhammer	289	Draht-		Flach-	
Ausgießer	121	bürste	323-325	fräsbohrer	218
Ausgußreiniger	35	seilklemme	340	maul-Schmiedezeange	345
Außentaster	142	Dreh-		schaber	298
Automatik-		momentschlüssel	103	Flanschenwinkel	134
messer	230	stange	102	Fleischhaken	160
Schutzhelm	318	Drill Bindewerkzeug	80-81	Fleisch- und Knochsäge	157
AUTOSOL-Produkte	258-261	Druckminderer	315, 316	Fliesen-	
Auto-Stromprüfer	68	Druck-Prüfpumpe	22	feile	226
Axt	180	Dübelzieher	157	kreuze + Keile	224
B		Durchschläger	292-293	lochsneider	223
Baghdad Säge	153	Düsen-		schneider	224
Band-		lehre	149	schneidmaschine	222
maß	132-133	reibbahnen	201	schwamm	227
säge	167	E		Forstnerbohrer	218
schlüssel	103	Einmaulschlüssel	109	Fräsapparat	22
Batterie Montage Lehre	23	Einzahnfräser	202	Freileitungsbauschlüssel	25
Bau-		Einziehband/-spirale	71-72	Froschklemme	340
säge	154-155	Elastikteller	267	Frostschutztester	105
schlüssel	25	Elektriker-		Fugen-	
stopfen	23	messer	73-78	gummi	224
Beilstiel	180	Schraubendreher	58, 60-61, 64	kratzer	226
Beißzange	49, 50, 273	Elektrodenhalter	313	meißel	298
Besenstiel	264	Elektro-LötKolben	304-305, 307	FUGI Silikonglätter	227
Betonstahlblechschere VITTE	283	Elektronikzangen	42-43, 46-47	Fühler-	
Biegezeange	27, 49, 273	Entgrater	20-21	lehre	146-147
BIT-		Entlötpumpe	304	lehenband	148
Schraubeinsatz	81-87	Entlüftungsschlüssel	25-26	Funkenfreie Werkzeuge	4
Schraubendrehersatz	86-87	Erdklemme/Polklemme	315	Furniersäge	155
Steckgriff-Schraubendreher	87	Ersatz-		G	
Blech-		klingen JOKARI Kabelmesser	74	Gabel-	
locher	21	kopf zu Plastikhammer	107	Ringschlüssel	108-111
scheren	276-279	Schneidrädchen	19-20, 223, 235	schlüssel	108-109
Blei-		F		Garniernadel	233
plombenzange	53	Fächerschleifer	330	Gasanzünder	312
rohr-Aufweitezange	30	Fäustel	286	Gehrungs-	
stift	136-137	Falzzange	344	Schneidlade	157
Blitz-Rohrzange	32	Farbpulver	229	säge	158
Bodenträger-		Farbrührer	226	Gelenkstück	254
schienen	269			Gewinde-	
Bogenzirkel	141			bohrer-Verlängerung	126
Bohrstichsäge	157			dichtband	23
Brauseschlauch	252			feile	125
Breitmaul-Gripzange	328			schablone	147

Gewinde-			
schneidkluppe	124		
schneidsatz	129		
stahllehre	147		
Gipserbeil	288		
Glas-			
bohrer	201		
brechzange	241		
schaber	238		
schneider	234-237		
Glättkelle	246-247		
Glättfix	227		
Goldschmiede-Schere	280		
Gradmesser	137		
Gripzangen	326-328		
Gummi-			
gipsbecher	229		
hammer	289		
H			
Hahnverlängerungsschlüssel	26		
Haken-Klingen	231		
Haken-schlüssel	111		
Halter für Fühlerlehrenband	148		
Hammer-	106-107, 284-289		
bohrer	187, 189, 191, 206-210		
Meißel	187-190, 209-211		
Hand-			
brause	253		
Drahtbürste	323		
drillbohrer	203		
Feilklobe	282-283		
gewindebohrer	124-125, 129		
säge	153-158, 160-162, 165		
schlagstempelsatz	336-337		
schleifblock	342		
schuhe	343		
schutz für Meißel	298		
schuttschild	317		
senker	200		
waschpaste	261		
Hanf-			
knäuel	24		
spule	24		
Hartlötpulver	311		
Hebel-			
Seitenschneider	46		
Vornschneider	46		
Heizkörper			
Entlüftungsschlüssel	26		
zu LötKolben	305, 307		
Henkelocheisen	290		
Hochdruck-Panzerschlauch	342		
Holz-			
axt	180		
stiel	180		
bandsägen	167		
hammer	289		
raspel	174, 178-179		
spiralbohrer	197, 217		
stiel	107, 180, 264, 286-287		
Hydraulik-Mundstück	342		
I			
ILSE Schnellspann-Schlüssel	31		
Innentaster	142		
J			
JAPAN Malerspachtelsatz	241		
JOKARI Abisoliermesser	73-76		
JUMBO Regler	316		
K			
Kabel-			
binder	70		
kupplung	314		
messer	73-78		
Schere	281		
schuh-Sortiment	55		
schuhpresszange	54-55		
trennmesser	77		
Kanister	121		
Karabinerhaken	339		
Karosserie-			
Feilenblatt	107		
Feilenhalter	107		
Kartuschenpistole	341		
Keil	224, 347		
Kellen	246-249		
Ketten-Rohrzange	33		
Ketten-			
sägefeile	173		
schlüssel	104		
Klaue für Mutternschlüssel	27		
Klebe-			
pistole	308		
stange	308		
Klingen	231		
Knarren	29, 114, 116-118		
Knochensäge	157		
Knopfmaß	145		
Kolbenring-			
spannband	104		
zange	104		
Kombinationszange	40-41, 44-45		
Kompressor	121		
Kontaktfeile	175		
Kontrollspiegel	326		
Kopf-Schutzschirm	317		
Kopf-/Stirnlampe	262		
Körner	291-293		
Kraftstoffkanister	121		
Kreissägeblatt	170-172		
Kreuz-			
hacke	264		
schlüssel	24-25, 102		
Kugelwindeisen	129		
Kunststoff			
Plastikhammer	106		
Rohrschere	18		
Kupferhammer	285		
Kuper-			
LötKolben	310		
Rohrabschneider	18-20		
rohr Biegezange	27		
L			
Ladezange	314		
Lamellenschleifteller	329		
Langlochbohrer	198		
Latthammer	288		
Laubsäge-			
blätter	162-163		
bogen	162		
Drillbohrer	163		
sägesatz	164-165		
tisch	163		
zwinge	163		
Lineal	140		
Loch-			
bohrer	225, 355		
eisen	290-291		
säge	355		
zange	50-52		
Löffelschaber	299		
Löt-			
draht	308-309		
fett in Dosen	310		
kolben	304-307, 310		
stange	309		
spitze zu LötKolben	307		
M			
Magnet-			
halter für Bits	88		
Hebewerkzeug	80		
schlüssel am Ring	113		
Malerspachtel	241-244		
Maschinen			
Langlochbohrer	198		
sägeblatt	167		
Maßstab	140-141		
Maulschlüssel	109		
Maurer-			
kelle	246-249		
Lotschnur	229		
Mausefalle	271		
Meißel	295-298		
Messer	230-231		
Metall-			
pflege	258-261		
sägeblatt	161, 166-167		
sägebogen	160-161, 165		
Zieh Klinge	242		
Mikrometer	149		
Montage-			
lehre	23		
zange	48		
Multimeter	69		
Mundstück	342		
Mutternschlüssel	26-27		
Mutternzange	27		

N			
Nägel	346	Riegel	343
Nagel-		Ringschlüssel	110-111
bohrer	200	Rinnenhalter-Biegezange	49, 273
eisen	168, 273	Rohr-	
heber	181	abschneider	18-20
Nestsägen	155	bearbeitung	17
Nietzange	39	biegezange	27
Nylon-		Einziehzange	31
Einziehband	71-72	entgrater	20-21
Hammer	106	gewindeschneidkluppe	124
Schutzbrille	319, 321	innenbürste	24
		reinigungswelle	35-36
		Schere	18, 30
		steckschlüssel	112-113
		zangen	31-35, 37
O		Roll-	
Öldienstschlüssel	104	bandmaß	132-133
Öl-		feder	270
filter-Schlüssel	103-104	gabelschlüssel	39
wannenschlüssel	104	RUBIN Schlagbohrer	191
Ösen-	51	Rücksäge	154
zange	51	Rund-	
		ahle	152
		bürste	324-325
		glasschneider	234
		locheisen	291
		maul-Schmiedezeange	345
		stahlhaken	347
P		S	
Pack-/Speernadel	233	Sackbinder/-driller	80-81
Panzerschlauch	342	Säge-	
Pilotbohrer	355	blatt	161-163, 166-167
PIMETER Umfangbandmaß	149	blatthalter	166
Pinsel-Bastlerbürste	325	Sägen	153-158, 160-162, 165
Pinzette	78-79	schränkzange	155
Pistolen-Gasanzünder	312	setzer	155
Plastikhammer	106-107	Salmiak-Lötstein	311
Plombenzange	53	Sanitär	
Politur	258-261	Armaturen Rohrzange	31
PRESSOL Standardfettpresse	342	Sanitär-Kreuzschlüssel	24-25
Presszange	54-55	S-Anschluss Montagewerkzeug	23
Profiltiefenmaß	145	SAPHIR Schlagbohrer	191
Prüfpumpe	22	Saugheber	238-241
PTFE-Gewindedichtband	23	Schaffner-Kontrollzange	52
PUK-		Schafschere	270
Säge	161	Schäkel	340
Sägeblatt	161	Schaber	298-299
PVC		Schalungsbohrer	198
Flächenspachtelsatz	242	Schaltshränkenschlüssel	25
Rohrschere	18	Scharnierlochbohrer	199
		Scheiben-	
R		Bastlerbürste	325
Rabitzzange	50	schneider	234
Radienschablone	147	Schieblehre	143-145
Radmutter Schlüssel	102	Schere	232, 276-281, 283
Rangierwagenheber	120	Scherenzange	45
Ratsche	29, 114, 116-118	Schlackenhammer	326
Presszange	55	Schlag-	
schlüssel	108-109	schlüssel	111
Rattenfalle	271	schnurroller	229
Raubtierfalle	271	schrauber	88
Rebensäge	153	Schlagstempel	336-337
Reduzierringe	172	Schlauch-	
Reibebrett	250-251	schelle	265-266
Reifenprofiltiefenmaß	145	schellendreher	88
Reifen-Ventil-Schraubendreher	102	schere	30
Reißnadel	142-143	Schleif-	
Revolverlochzange	50-51	klotz	342
		scheibe	331
		scheibenabrichter	335
		stein	169
		Schlosser-	
		hammer	284-285
		winkel	134
		Schlossriegel	343
		Schlüssel-	
		anhänger	268
		feilensatz	173
		ring	268
		Schmiedezeange	344-345
		Schmiegenwinkel	135
		Schneid-	
		eisen	126
		eisenhalter	127
		kopf zu Glasschneider	237
		lade	156-157
		rädchen	19-20, 223, 235
		Schnellspannschlüssel/Zange	31, 38
		Schrauben-	
		ausdreher	201, 219
		dreher	58-65, 69
		dreher-Einsatz	115
		drehersatz	62-65
		Schraub-	
		locher	21
		stock-/backen	302
		zwingen	302-303
		Schreinerwinkel	134-135
		Schruppscheibe	334
		Schutz-	
		brillen	319-321
		glas für Schutzschild	322
		helm	318, 343
		schild	317-318
		Schwammgummi-	
		Reibebrett	250-251
		Schweißer-	
		brille	321
		Gripzange	326
		Schweißer-	
		Kontrollspiegel	326
		schutzglas	322
		schutzschild	317-318
		Schweißkabel	314
		Schwerlastdübel	300
		Seilspannklemme	340
		Seitenschneider	40-41, 44-46
		Senker für Holzarbeit	199-200
		Senklot	138
		Setzeisen	301
		S-FIX Keile	347
		Sicherungszeange	48-49
		Signierkreide	228
		Signierschablonensatz	338

Silikon-Pistole 341
 Simplexhaken 339
 Spachtel 241-245
 Spannungsprüfer 65-69
 Spezial-
 Montagezange 48
 Ölwannenschlüssel 104
 Spiegel-
 halteklammern 255
 Klebeband 232
 Spiralbohrer 192-197, 211-217
 Spitzzirkel 141-142
 Splintentreiber 294
 Sprühkopf 254
 Stahl-
 einziehband 71-72
 lineal 140
 maßstab 140-141
 nägel 346
 Standhahn
 Mutternschlüssel 26-27
 Mutternzange 27
 Stangenscharnier 181
 Stechbeitel 168
 Steckgriff-Schraubendreher 87
 Steckschlüssel 112-113
 einsatz 115, 117, 119
 satz 114, 116
 Schraubendreher 89
 Steinbohrer 184-191, 204-210
 Stempel für Plombenzange 53
 Stichsäge 153
 blatt 350-354
 Stiele 107, 180, 264, 286-287
 Stiftschlüssel 90-92, 97
 im Halter 93, 98
 satz 90, 92-95, 98-99
 Schraubendreher 96-97
 Stirn-
 lampe 262
 lochschlüssel 112
 Stockschraubenschlüssel 26
 Stopfenschlüssel 24
 Streichmaß 137, 167
 Streifenhobelmesser 169
 Stromprüfer 68
 Stufenschlüssel 28-29
 Syphonzange 32

T
 Taschenfederwaage 270
 Tauchsieder 272
 Telefon-
 und Kabelschere 281
 Telefonzange 40-41, 44-45
 TELESKOP Mutternschlüssel 26
 Teppichmesser 230-231
 T-Griff Stiftschlüsseldreher 96-97
 Topf-Bastlerbürste 325
 Topfbürste 324
 TORPEDO Wasserwaage 138
 TORX Schraubendreher 59, 97-99

Trapez-Klingen 231
 Trennscheibe 332-335
 Tür-
 besen-/Bodendichtung 232
 scharnier 340
 stopper 270

U
 Umfangbandmaß 149
 Umsteckschraubendreher 62
 Universal-
 Gewindefeile 125
 Messer 230-231
 Schaltschrankschlüssel 25
 Ventilhalter 26
 Unterstellbock im Satz 120

V
 Ventil
 einschleifer 106
 feder Spannapparat 105
 halter 26
 schraubendreher 102
 stopfen 35
 Verfügbrett 250
 Vergaserschraubendreher 62
 Verschlusshülse 181
 Vierkantahle 152
 Vollleder-Arbeitshandschuhe 343
 Vornschneider 41, 46
 Vorschlaghammer 287
 Vorstechahle 152

W
 Wagenheber 120
 WALBY Maurerkelle 249
 Wandhaken 254
 Waschtisch Armaturen-Schlüssel 26
 Wasser-
 hahn-Fräsaparat 22
 pumpenzange 37-38
 schieber 228
 waage 138-139
 Weichlötmasse 310
 Wendelrührer 226
 Werkstatt-
 feile 173-179
 Mikrometer 149
 Werkzeug-
 halter 127-128
 koffer 120-121, 267
 satz 297
 Wetzstahl 159
 Windeisen 128-129
 Winkelschraubendreher 69, 90-99
 Wirbel 339
 Wolfsmaul-Schmiedezange 344

Z
 Zahnspachtel 245
 Zangen diverse 40-47
 Zentrierbohrer 219
 Zentrumböhrer 199
 Ziehklingen 160, 242-243
 Zimmermanns
 bleistift 136-137
 bleistifthalter 136-137
 winkel 136
 Zirkel 141-142
 Zubehör für Lochbohrer 225
 Zündkerzen-
 bürste 103
 schlüssel 103
 Zündstein 312
 Zurrgurt 263

Impressum

Ausgabe: 2015/2016

Herausgeber: Dönges GmbH & Co. KG
 Jägerwald 11
 D-42897 Remscheid

Copyright: Dönges GmbH & Co. KG

Redaktion: Wolfgang Schulz
 Wilfried Funk

Gestaltung: Birgit Zimmermann
 Roland Hontheim

Fotos: Fotolia, Industrie,
 Birgit Zimmermann

Alle Fotos sind urheberrechtlich geschützt.
 Sortiment freibleibend, keine Haftung bei Irrtümern und Druckfehlern.
 Produktänderungen bleiben uns vorbehalten. Vervielfältigung jeglicher Art, auch auszugsweise, darf nur mit schriftlicher Genehmigung erfolgen.

A		Butcher's		Copper	
Abrasive flap wheel	330	saw	157	tube bending pliers	27
Adapter set	81	saw blade	157	tube cutter	18-20
Adhesive tape	232	steel	159	Countersink drill	199-200
Adjustable		Button gauge	145	Coupler	342
connector	254			Crimp pliers	54-55
face spanner	112	C		Crimping pliers	54-55
wrench	39	Cabinet key	25	Curved bearing scraper	299
Allen		Cable		Cut-off wheel	332-335
key	90-92, 97	knife	73-78	Cutting disc	332-335
key in holder	93, 98	lugs assortment	55		
key screwdriver	96-97	scissor	281	D	
key set	90, 92-95, 98-99	tie	70	Desoldering pump	304
Aluminium		Caliper	143-145	Diagonal cutter	45
lay on jaws	302	Cans	121	Diamond cutting disc	332-333
rule	140	Carburettor screwdriver	62	Die stock	127
spirit level	138-139	Carlight tester	68	Dividers	141-142
Anchor	300	Carpenter's		Door	
Animal trap	271	pencil	136-137	bolt	343
Anti freeze tester	105	pencil holder	136-137	buffer	270
Arbour for hole saw	355	pincer	50	Dovetail saw	156
Arch punch	290	square	134-136	Dowel extractor	157
Auger bit	218	Carpet knife	230-231	Drain	
Autodarkening welding helmet	318	Case opener	168	adjustment pliers	32
Automatic knife	230	Caulking gun	341	plug wrench	104
AUTOSOL product	258-261	Center		Draught excluder	232
Axe	180	drill	219	Draw-in band /-spiral	71-72
Axel stand set	120	punch	291-293		
		Centre bit	199	E	
B		Chain		Earth clamp	315
Back saw	154	pipe wrench	33	Eaves gutter bending pliers	49, 273
Baghdad saw	153	saw file	173	Elastic pad	267
Ball		wrench	104	Electrician's	
pane hammer	289	Chalk	229	knife	73-78
tap wrench	129	Chalk line	229	screwdriver	58, 60-61, 64
Band saw	167	Charging clamp	314	Electrode holder	313
Bar cutter „VITTE“	283	Chisel	295-298	Electronic pliers	42-43, 46-47
Basin plug	35	Chisel-Punch tool set	297	Empty tool box	120-121, 267
Battery charging clamp	314	Circle glass cutter	234	End brush	325
Bending pliers	27, 49, 273	Circlip pliers	48-49	Extension for tap	126
Binding clip	181	Circular		Eyelet	51
Bit		saw blade	170-172	pliers	51
screw insert	81-87	wire brush	324		
screw insert set	86-87	Circumference rule	149	F	
screwdriver handle	87	Coach hinges	340	F-Clamp	302-303
Blacksmith's tong	344-345	Coachwork		Feeler	
Blades for knives	231	file	107	gauge	146-147
Blitz wrench	32	file holder	107	gauge tape	148
Block cutting knife	169	Combination pliers	40-41, 44-45	Fibre disc	331
Bolt	343	Combined spanner	108-110	File	173-179
Bottle jack	120	Come along clamp	340	brush	175
Bottom carrier	269	Compass saw	153, 157	Fire fighting equipment	4
Bow saw	158	Compressor	121	FIT pliers	45
Bracket	269	Concrete mixer	226	Fitting brush	24
Brake spring pliers	105	Contact file	175	Flange square	134
Branch saw	154	Control mirror	326	Flap	
Brazing powder	311	Coping		disc	329
Breast drill	203	saw blade	162-163	wheel	330
Broom	264	saw clamp	163	Flat	
handle	264	saw frame	162	square scraper	298
Butcher's		Copper		steel band	71-72
hook	160	hammer	285		



Flat wood working drill	218	Hatchet	180	Magnet spanner	113
Flint	312	Head lamp	262	Magnetic	
Float	250-251	Heater Airing key	25-26	holder	88
Foam, rubber wiper	228	Helmet	343	pick-up tool	80
Forstner drill	218	Hemp rope	24	Marking	
Four-way wrench	24-25, 102	Hexagonal screwdriver	90-92, 97	crayon	228
Frame wood drill	198	High pressure hose	342	gauge	137, 167
Fretwork		Hinge	181	Masonry drill	184-189, 191, 204-210
blade	162-163	hole cutter	199	Mason's string	229
drill	163	Holder for feeler gauge tape	148	Measuring tape	132-133
frame	162	Hole		Meat hook	160
table	163	saw	225, 355	Mechanic's square	134
tool sets	164-165	saw accessories	225, 355	Metal	
Front cutter	41	Hollow punch	291	anchor	300
Fuel jerrycans	121	Hook	347	cutting shear	276-279
FUGI for smoothing silicon	227	blade	231	polish	258-261
G		spanner	111	saw blades	161, 166-167
Gap chisel	298	Hose		Micrometer	149
Garnishing needle	233	clamp	265-266	MINI Compressor	121
Gas		clip screwdriver	88	Mirror clip set	255
lighter	312	cutting shear	30	Mitre	
pipe wrench	24	Hydraulic coupler	342	box	156-157
Gasket cutter	234	Hydro sponge float	250-251	saw	158
Gimlet	200	I		Mortise bits	198
Glass		ILSE quick wrench	31	Mountings- setting	
breaking pliers	241	Immersion heater	272	up-loam board	23
cutter	234-237	Impact screwdriver	88	Mouse trap	271
drill	201	Inside		Multimeter	69
scraper	238	divider	142	N	
Glättfix	227	pliers	30	Nail	346
Glove	343	Insulating material knife	230	puller	181
Glue		JAPAN Wall scraper set	241	set	292-293
gun	308	Jet gauge	149	setter	301
stick	308	Jeweller saw frame	162	Nest of saw	155
Grease gun	342	Jeweller's snip	280	Non sparking tool	4
Grinding		Jig saw blades	350-354	Nozzle reamer	201
block	342	JOKARI Knife	73-76	Number punch set	336-337
disc	331, 334	JUMBO regulator	316	Nylon	
stone	169	K		Draw-in band	71-72
Grip pliers	326-328	Key		hammer	106
Grout rake	226	ring	268	protection goggle	319-321
Gypsum		tag	268	O	
cup	229	Knife	73-78, 230-231	Offset screwdriver	69
hatchet	288	L		Oil	
H		Lashing system	263	drain plug wrench	104
Hacking knife	77	Lead seal pliers	53	filter key	103-104
Hacksaw frame	160-161, 165	Letter punch set	336-337	Oilfilter strap key	103
Hammer		Lever		Open end spanner	108-109
chisel	187-188, 190, 209-211	cutting nipper	46	Outside divider	142
drill	186-189, 191, 206-210	side cutting nipper	46	P	
Hand		Long nose pliers	40-41, 44-45	Packing needle	233
cleaning paste	261	M		Paint mixer	226
drill	203	Machine		Parallel pin punch	294
protector for chisel	298	mortise bits	198	Piano Hinge	181
saw	153-158, 160-162, 165	saw blade	167	Pick axe	264
shower	253	Machinist's files	173-179	Piercer	152
tap	124-125, 129	Machinist's hammer	284-285	Pilot drill	355
vices	282-283			Pipe cleaner	35-36
wire brush	323				
Handle	107, 180, 264, 286-287				

P			
Pipe			
crimper	31		
reamer	20-21		
wrenches	31-35, 37		
Piston			
ring pliers	104		
ring tightening strap	104		
Plastic			
float	250-251		
hammer	106-107		
Pliers, diverse	40-47		
Plugging chisel	168		
Plumb bob	138		
Pocket balance	270		
Polishing material	258-261		
Pot brush	324-325		
Precision caliper	143-145		
PRESSOL Grease gun	342		
Pressure			
regulator	315-316		
test pump	22		
Protecting			
goggle	319-321		
helmet	343		
shield	317		
Protractor	137		
Pruning saw	153-154		
PTFE screw thread band	23		
PUK			
saw	161		
saw blade	161		
Punch	290-291		
Punches for lead seal pliers	53		
Punching tool	21		
PVC			
cutting shear	18		
Scraper	242		
Tube cutting shear	18		
Q			
Quick spanner wrench	31-32, 38		
R			
Radius gauge set	147		
Rail	269		
Rasp	174, 178-179		
Rat trap	271		
Ratchet	29, 114, 116-118		
crimping pliers	55		
spanner	108-109		
Reamer	20-21		
Redressing tool	335		
Reduction ring for saw blades	172		
Reinforcement steel			
cutting shear	283		
Resistance for			
Soldering iron	305, 307		
Reversible screwdriver	62		
Revolving punch pliers	50-51		
Rim wrench	102		
Ring spanner	110-111		
Rivetting pliers	39		
Roofing hammer	288		
Round			
die	126		
wire brush	325		
Rubber			
cup	229		
foam float	250-251		
mallet	289		
pad	267		
tile joint	224		
RUBIN Hammer drill	191		
Rule	140-141		
S			
Safety glasses	319-321		
Sal ammoniac stone	311		
Sanitary			
fitting wrench	31		
key	26		
rim wrench	24-25		
wrench	26, 31-32		
SAPHIR Hammer drill	191		
Saw	153-158, 160-162, 165		
blade	161-163, 166-167		
blade holder	166		
set	155		
set pliers	155		
Scissor	232, 280-281, 283		
Scraper	160, 241-245, 298-299		
steel	160		
with teeth	245		
Screw			
clamp	302-303		
extractor	201, 219		
in tool	23		
pitch gauge	147		
thread band	23		
Screwdriver	58-65, 69		
set	62-65		
socket	115		
S-FIX wedge	347		
Shakle	340		
Sheep shear	270		
Sheet shear	276-279		
Shell drill	200		
Shower hose	252		
Side cutter	40-41, 44-46		
Silicone gun	341		
Single			
flute cutter	202		
spanner	109		
Sink cleaner	35		
Slate ripper	273		
Sledge hammer	286-287		
Sliding bevel	135		
Slip on claw	27		
Slogging spanner	111		
Snap hook	339		
Socket	115, 117, 119		
nut driver	89		
set	114, 116		
Solder rod	309		
Soldering			
copper	310		
grease	310		
iron/-gun	304-307, 310		
paste	310		
point for iron	307		
wire	308-309		
Spare			
blade JOKARI	74		
cutting wheel	19-20, 223, 235		
head for Glass cutter	237		
head for plastic hammer	107		
Spark			
plug brush	103		
plug wrench	103		
Spirit level	138-139		
Spout	121		
Square	134		
Steel			
cutting shear	283		
hooks	347		
nails	346		
punch set	336-337		
rule	140-141		
scraper	142-143		
Stencil plate set	338		
Stepped key	28-29		
Stock & die set	124		
Stop plug	23		
Strap key	103		
Suction lifter	238-241		
Swivel	339		
T			
Tap			
holder	127-128		
wrench	128-129		
Telephone			
& Cable scissor	281		
pliers	40-41, 44-45		
Telescopic wrench for water tap	26		
T-Handle socket	113		
nut driver	89		
Thread			
cutting set	129		
gauge	147		
repairing file	125		
Three square			
flat ground scraper	299		
hollow ground scraper	299		
Ticket punch plier	52		
Tile			
cross and wedge	224		
cutter	224		
cutting machine	222		
file	226		
hole cutter	223		
sponge	227		
Tiler's pliers	49, 273		
Tiler's trowel	248		

Tinmen's shear	276-279	Wiper	228
Tinner's pliers	344	Wire	
Tommy bar	102	bending drill	80-81
Tool		brush	323-325
box	120-121, 267	rope clip	340
set	297	stretcher	340
TORPEDO spirit level	138	stripper	41, 45
Torque wrench	103	Wood	
TORX screwdriver	59, 97-99	axe	180
Tower pincer	50	chisel	168
TRAPEZ blade	231	working drill	197, 217
Trolley jack	120	Wooden	
Trowel	246-249	axe handle	180
Tube		hammer	289
bending pliers	27	handle	107, 180, 264, 286-287
cutter	18-20	Working glove	343
works	17	Wrecking bar	168
Tubular box spanner	112-113	Wrench for	
Tweezer	78-79	stock screw	26
Twist drills	192-197, 211-217	water tap	26-27
Tyre			
profile depth gauge	145		
valve screwdriver	102		
U			
U-rail	269		
V			
Valve			
grinder	106		
holder	26		
lifter	105		
seat reaming device	22		
Veneer cutter	155		
Vice	302		
Voltage tester	65-69		
Volute spring	270		
W			
WALBY Trowel	249		
Wall hook	254		
Warding file set	173		
Washbasin wrench	26		
Watchmaker's screwdriver	79-80		
Water			
fix	254		
pump nut pliers	27		
pump pliers	37-38		
Webbing load	263		
Wedge	347		
Welding			
cable	314		
cable connector	314		
glass	322		
goggle	321		
grip pliers	326		
hammer	326		
helmet	317-318		
mask	317		
mirror	326		
shield	317-318		

Impression

Issue: 2015/2016

Issued by: Dönges GmbH & Co. KG
 Jägerwald 11
 D-42897 Remscheid

Copyright: Dönges GmbH & Co. KG

Editorial: Wolfgang Schulz
 Wilfried Funk

Graphics: Birgit Zimmermann
 Roland Hontheim

Photos: Fotolia, Industry,
 Birgit Zimmermann

All photos protected by copyright.
 Product range subject to change, no
 liability accepted for mistakes or
 printing errors. Right reserved to
 make product changes. Copying of
 any kind, even of extracts, requires
 written permission.



**Schneidwerkzeuge**

Rohrscheren	18, 30
Rohrabschneider	18-20
Entgrater	20-21
Schraub-/Doppellocher	21

Cutting tools

Tube cutting shears	18, 30
Tube cutters	18-20
Pipe reamer	20-21
Punching tools	21

**Prüf-/
Montagewerkzeuge**

Prüfpumpe	22
Wasserhahn-Fräsapparate	22
Ein-/Ausschraubwerkzeug	23
Montagelehre	23
Ratschen	29
Montageschlüssel	24-29, 39

**Test-/
fitting tools**

Pressure test pump	22
Valve seat reaming device	22
Screw in tool	23
Mounting gauge	23
Ratchets	29
Installation wrenches	24-29, 39

**Zangen**

Sanitärbedarf	27, 30-35, 37-38
Elektronikbedarf	42-43, 46-47
Dachdeckerbedarf	49-50
div. Bedarf	39-41, 44-45, 48-50

Pliers

Sanitary demand	27, 30-35, 37-38
Electronic demand	42-43, 46-47
Roofer's demand	49-50
div. demand	39-41, 44-45, 48-50

**Reinigung**

Ausgußreiniger	35
Rohrreinigungswellen	35-36

Cleaning

Sink cleaner	35
Pipe cleaners	35-36

**Loch-/
Stanzwerkzeug**

Loch-/Ösenzangen	50-51
Schaffner-Kontrollzangen	52
Bleiplombenzangen	53
Presszange	54-55

**Punch-/
pressing tools**

Punch-/eyelet pliers	50-51
Ticket punch pliers	52
Lead seal pliers	53
Crimping pliers	54-55

**Zubehör**

Gewindedichtband	23
Baustopfen	23
Fittingsbürste	24
Hanfspule/-knäuel	24
Entlüftungsschlüssel	25-26
Ventilstopfen	35

Accessories

Screw thread band	23
Stop plug	23
Fitting brush	24
Hemp rope	24
Heater Airing key	25-26
Basin plug	35

Kunststoff-Rohrschere PROFİ

- mit eingezogener Klinge
- Messer ohne Schraubendreher/Schlüssel austauschbar
- „INOX“ Klinge „Made in Solingen“
- mit PTFE Beschichtung

PVC Tube cutting shear PROFİ

- ratchet system
- blade exchangeable by hand
- „INOX“ blade „Made in Solingen“
- PTFE coated



Bestell-Nr. Order-no.	Artikel Item	bis Ø mm up to Ø mm
21-100042-0	Rohrschere/tube shear	42
21-100063-0	Rohrschere/tube shear	63
21-101042-0	Ersatzklinge/spare blade	42
21-101063-0	Ersatzklinge/spare blade	63

**Kunststoff-Rohrschere STANDARD**

- Ratschenmechanik
- mit Entgrater

PVC Tube cutting shear

- ratched system
- with countersink



Bestell-Nr. Order-no.	Artikel Item	bis Ø mm up to Ø mm
21-105000-9	Rohrschere/tube shear	42
21-106010-9	Ersatzklinge/spare blade	42
21-107020-9	Feder für Handratsche/ spring for ratched	
21-107030-9	Feder für Sperrklinke/ spring for closing	

**Kupfer-Rohrabschneider MINI**

mit zwei Führungsrollen und einem Schneidrad

Copper tube cutter MINI

with two guide rolls and one cutting wheel

Bestell-Nr. Order-no.	Ø mm Ø mm
21-108016-0	3-16
21-108525-0	3-25
21-109030-0	3-30



Kupfer-Rohrabschneider

mit zwei Führungsrollen und einem Schneidrad

Copper tube cutter

with two guide rolls and one cutting wheel

Bestell-Nr.
Order-no.**21-110035-0**Ø mm
Ø mm

3-35

KOMBI-Rohrabschneider

- mit zwei Schneidrädchen
- austauschbar für Alu, Cu & Inox und Plastik
- mit Entgrater
- mit vier Führungsrollen

Tube cutter for copper & plastic

- with two changable cutting wheels
(one for PVC, one for Alu, Cu & Inox)
- with countersink
- four guide rolls

Bestell-Nr.
Order-no.**21-111035-0**Ø mm
Ø mm

3-35

**Ersatz-Schneidrädchen**zum Schneiden von PVC Rohren
Ø 3-35 mm**Spare cutting wheel**for cutting PVC tubes
Ø 3-35 mmBestell-Nr.
Order-no.**21-111510-0**Ø x Stärke mm
Ø x thickness mm

22 x 5

für Rohrabschneider
for tube cutter

21-108.. bis/up 21-111..

Ersatz-Schneidrädchenzum Schneiden von Alu-, Cu- & Inox Rohren
Ø 3-35 mm**Spare cutting wheel**for cutting Alu-, Cu- & Inox tubes
Ø 3-35 mmBestell-Nr.
Order-no.**21-112020-0**Ø x Stärke mm
Ø x thickness mm

19 x 5

für Rohrabschneider
for tube cutter

21-108.. bis/up 21-111..

Rohrabschneider KOMPAKT PLUS

- PT QUICK
- zum Schneiden von dünnwandigen Kunststoffrohren bis Wandstärke 16,8 mm

Tube cutter KOMPAKT PLUS

- for cutting thin walled pvc tubes with wall thickness up to 16,8 mm

Bestell-Nr. Order-no.	Ø mm Ø mm
21-115000-0	50-127
21-115001-0	100-170

**Ersatz-Schneidradchen**

zum Schneiden von dünnwandigen Kunststoffrohren bis Wandstärke 16,8 mm

Spare cutting wheel

for cutting thin walled pvc tubes with wall thickness up to 16,8 mm



Bestell-Nr. Order-no.	Ø x Stärke mm Ø x thickness mm	für Rohrabschneider for tube cutter
21-115500-0	45 x 11	21-11500..

Ersatz-Schneidradchen

zum Schneiden von ALU, CU- & INOX (max. Wandstärke bis 6 mm)

Spare cutting wheel

for cutting ALU, CU- & INOX (max. wall thickness 6 mm)



Bestell-Nr. Order-no.	Ø x Stärke mm Ø x thickness mm	für Rohrabschneider for tube cutter
21-115600-0	25 x 11	21-11500..

Rohrabschneider für Stahlrohre

mit zwei Führungsrollen und einem Schneidrad

Pipe cutter for steel tubes

with two guide rolls and one cutting wheel



Bestell-Nr. Order-no.	für Rohre Ø Zoll for pipes Ø inch
21-122002-0	1/8-2
21-122004-0	1 1/4-4

**Ersatz-Schneidradchen**

zum Schneiden von Stahl- & Inox Rohren

Spare cutting wheel

for cutting steel- & Inox tubes



Bestell-Nr. Order-no.	Ø x Stärke mm Ø x thickness mm	für Rohrabschneider for tube cutter
21-123002-0	31 x 19	21-122002-0
21-123004-0	41 x 28	21-122004-0

Rohrentgrater aus Metall

für Innen- und Aussenentgratungen von Kupfer- und Kunststoffrohren

Pipe reamer, all metal

for internal & external reaming for copper and PVC tubes



Bestell-Nr. Order-no.	Arbeitsbereich Ø mm Working area Ø mm
21-128042-9	3-2

Entgrater aus Aluminium/Stahl

für Innen- und Aussenentgratungen von Kupfer- und Kunststoffrohren

Pipe reamer, aluminium/steel

for internal & external reaming for copper and PVC tubes



Bestell-Nr.
Order-no.

21-128535-0
21-128556-0

Arbeitsbereich Ø mm
Working area Ø mm

8-35
10-56



Schraublocher mit 3-Punkt Anschnitt

zum Stanzen von Blechen aus Edelstahl, Alu, Stahl, Kupfer usw.

Punching tool with 3 point cut

useable for punching sheets of stainless steel, aluminium, normal steel, copper etc.



Bestell-Nr.
Order-no.

21-130001-0
21-130020-0
21-130021-0
21-130002-0
21-130022-0
21-130023-0
21-130024-0
21-130025-0
21-130026-0
21-130027-0
21-130008-0
21-130028-0
21-130029-0
21-130030-0
21-130043-0
21-130031-0
21-130003-0
21-130014-0
21-130032-0
21-130033-0
21-130034-0
21-130035-0
21-130036-0
21-130037-0
21-130038-0
21-130039-0
21-130040-0
21-130041-0
21-130042-0

Loch Ø mm/Zoll
Hole Ø mm/inch

20,0 mm
20,4 mm/M 20
21,0 mm
22,0 mm
22,5 mm
23,0 mm
24,0 mm
25,2 mm/M 25
26,0 mm
27,0 mm
28,0 mm
28,3 mm-1 1/8"
29,0 mm
30,0 mm
30,5 mm
31,0 mm
32,5 mm
32,2/M 32
32,0 mm-1 1/4"
33,0 mm
34,0 mm
35,0 mm
36,0 mm
37,0 mm
38,0 mm
39,0 mm
40,2 mm/M 40
41,0 mm
42,0 mm

Nennmaß-Pg
Basic size

-
13,5
-
-
16
-
-
-
16
-
-
-
21
21
-
-
-
-
21
21
-
-
21
21
29
39
-
-
-
-

Doppelblechlocher mit drei-Punkt Anschnitt

zum Stanzen von Blechen aus Edelstahl, Alu, Stahl, Kupfer u.s.w.

Double Punching tool with three point cut

useable for punching sheets of stainless steel, aluminium, normal steel, copper etc.



Bestell-Nr.
Order-no.

21-130528-0
21-130532-0

Loch Ø mm
Hole Ø mm

28 x 32
23 x 35

Druck- Prüfpumpe mit einer Messuhr

- Wanne rot lackiert
- Tankinhalt 12 Liter
- Betriebsdruck bis 60 bar
- Anschluss 1/2"
- 1,5 m Flex-Schlauch

Pressure test pump with one manometer

- red lacquered
- 12 liter tank
- pressure up to 60 bar
- 1/2" connection
- flexible hose 1,5 M

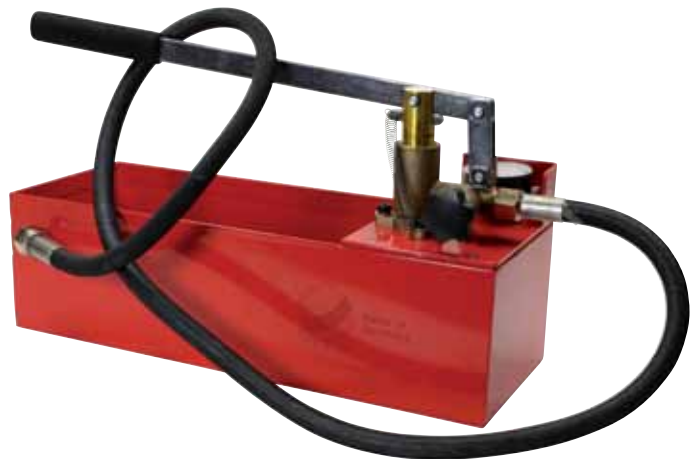

Bestell-Nr. Order-no.	Artikel Item	L x B x H mm L x W x H mm
21-133000-0	Prüfpumpe/Test Pump	500 x 175 x 145
21-133001-0	Ersatzprüfuhr/ spare manometer	

Wasserhahn-Fräsaparat PROFI

- mit Metall-Drehknopf
- zylindrische Form in roter Metallkassette

Valve seat reaming device Profi

- with metal rotary knob
- cylindric form, in red metal box

Bestell-Nr. Order-no.	Fräser Ø Zoll Reamer Ø inch
21-140001-0	3/8, 1/2, 3/4
21-140002-0	3/8, 1/2, 3/4, 1
21-140003-0	1/4, 3/8, 1/2, 3/4, 1
21-142000-0	Leerkassette/empty case

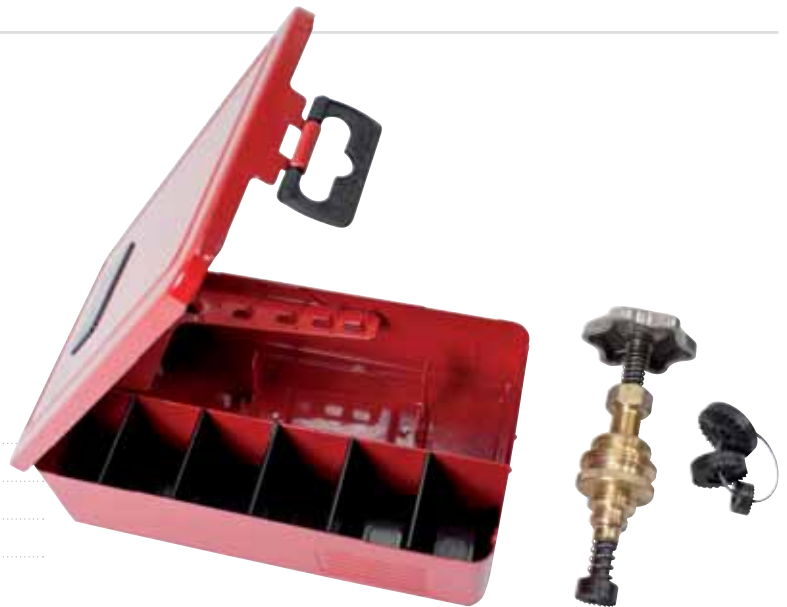
**Ersatzfräser**

- flach
- für Fräsaparat

**Spare reamer**

- flat
- for valve seat reaming device

Bestell-Nr. Order-no.	Fräser Ø Zoll Reamer Ø inch
21-149014-0	1/4
21-149038-0	3/8
21-149012-0	1/2
21-149034-0	3/4
21-149001-0	1

Wasserhahn-Fräsaparat PROFI

- mit Metall- Drehknopf
- zylindrische Form

**Valve seat reaming device**

- with metal rotary knob
- cylindric form



Bestell-Nr. Order-no.	Fräser Ø Zoll Reamer Ø inch
21-145001-0	3/8, 1/2, 3/4
21-145002-0	3/8, 1/2, 3/4, 1
21-145003-0	1/4, 3/8, 1/2, 3/4, 1

S-Anschluss Montagewerkzeug

zum Ein- und Ausschrauben von S-Anschlüssen

Screw in tool for sanitary fitting

for in- and out screwing of S-connections

Bestell-Nr.
Order-no.

21-152000-0

Antrieb
Drive

1/2"-4-kant/point



Batterie Montage Lehre

- für Armaturenanschlüsse
- mit Tiefenverstellung
- für schnell veränderbare Stichmaße
- Aufnahme 3/8" und 1/2"
- mit 1 Libelle horizontal

Mountings- setting up-loam board

- for mounting of water mixer
- depth adjustment
- for quick changable depth gauge
- connection 3/8" + 1/2"
- with 1 horizontal bubble



Bestell-Nr.
Order-no.

21-155000-9

21-157000-9

Artikel
Item

lose/single

im Kasten/in case

Stichmaße mm
depth gauges mm

75-100-120-153-200-240

75-100-120-153-200-240



Baustopfen nach DIN 1988

mit Messing-Gewinde

Stop plug accord. to DIN 1988

for pressure stop, with brass thread



Bestell-Nr.
Order-no.

21-160012-0

21-160034-0

21-160012-1

21-160034-1

Gewinde Zoll
Thread inch

1/2

3/4

1/2

3/4

Farbe
Colour

blue

blue

red

red

PTFE-Gewindedichtband

weiss, zum Abdichten von Wasser-Rohrverbindungen

PTFE screw thread band

white, for tightening water pipe connections



Bestell-Nr.
Order-no.

21-162012-0

Breite x Stärke mm
Width x thickness mm

12 x 0,08

Länge m
Length m

12

Fittingbürste (Rohrinnenbürste)

- Besatz aus Stahldraht
- mit flachem Holzgriff

Fitting-brush

- with steel wire
- flat wooden handle



Bestell-Nr.
Order-no.

Bürste Ø mm
Brush Ø mm

[21-165010-0](#)

10

[21-165012-0](#)

12

[21-165015-0](#)

15

[21-165018-0](#)

18

[21-165022-0](#)

22

[21-165028-0](#)

28

Hanfspule

gewickelt auf Pappkern

Hemp rope

on spool



Bestell-Nr.
Order-no.

[21-168080-9](#)

Gewicht g
Weight g

80

Hanfknäuel

gewickelt

Hemp rope

wrapped



Bestell-Nr.
Order-no.

[21-169010-9](#)

Gewicht g
Weight g

100

Sanitär- & Heizungs-Kombi-Kreuz

- mit 14 Funktionen
- für Hahn- u. Heizkörperverlängerungen
3/8" - 1/2" - 3/4" - 1"
- zum Ein- und Ausbau von Heizkörperventilen
und Rücklaufverschraubungen
- Waschtischbefestigung SW 10, SW 21, SW 17, SW 22
- für Stockschrauben M6 -8 -10 -12
und Rohrstopfen 3/8", 1/2"
- Sechskantmitnahme SW 17, SW 22

Sanitary rim wrench

- with 14 functions
- for plug valve and radiator extension
3/8" - 1/2" - 3/4" - 1"
- for mounting and removal of radiator valves
- washbasin mounting SW 10, SW 21, SW 17, SW 22
- hunger bolts M6 -8 -10 -12 and plug connection
3/8", 1/2"



Bestell-Nr.
Order-no.

[21-170000-9](#)

Länge mm
Length mm

220

Gasrohr-Stopfenschlüssel

zum Ein- und Ausdrehen von Stopfen
3/8" - 1/2" - 3/4" - 1"

Gas pipe wrench

for screwing in & out of Gas plugs
3/8" - 1/2" - 3/4" - 1"



Bestell-Nr.
Order-no.

[21-172020-0](#)

Länge mm
Length mm

200

Sanitär-Kreuzschlüssel

- zum Ein- und Ausbauen von Hahnverlängerungen in 3/8"-1/2"-3/4"-1"
- sowie Express-Schrauben M8 -10 -12
- Aussen-6-kant SW 10 - 12 - 17 - 22

Sanitary rim wrench

- external hexagon 3/8" - 1/2" - 3/4" - 1" on and dismounting of radiator valves and lockshields
- internal thread and hunger bolts M8 -10 -12 for vanity fixtures
- outside hexagonal SW 10 - 12 - 17 - 22



Bestell-Nr.
Order-no.

21-174000-9

Länge mm
Length mm

200

Universal-Schaltschrankschlüssel

- mit Kette
- Wendebit und Adapter
- mit Heizungsentlüftungs-Schließung

Universal cabinet key

- with chain
- turnable bit and adapter
- with radiator ventilation key



Bestell-Nr.
Order-no.

21-178000-0

Länge mm
Length mm

72

Freileitungsbauschlüssel

chromatisiert

Cabinet key

rood galvanized



Bestell-Nr.
Order-no.

21-176010-0

Länge mm
Length mm

10, 13, 14, 17

21-176011-0

11, 13, 14, 17



Sanitär-/Klima-/ Gebäudetechnik- Schlüssel

für Sanitär-, Heizungs-, Klima-, Lüftungs- und Neubaubereich, mit Wendebit

Wrench for switch cabinet

for sanitary, radiator, conditioning, ventilation and new construction use, with turnable bit



Bestell-Nr.
Order-no.

21-179000-0

Länge mm
Length mm

90 x 62

Stockschrauben-Montageschlüssel

- Aufnahme verstellbar
- verchromt

Wrench for stock screws

- absorption adjustable
- chrome plated



Bestell-Nr. Order-no.	für Aufnahmen connecting	Antrieb Zoll Drive inch
21-180000-0	M 6 - 8 - 10 - 12	1/2

Hahnverlängerungsschlüssel

mit Außensechskant für Hahnverlängerungen

Sanitary key

with external hexagonal for tap extension



Bestell-Nr. Order-no.	Abmessung Size
21-185000-0	1/2"-3/4" bzw. 12-17 mm + 4-kant/point 10 mm

Heizkörper-Entlüftungsschlüssel

- besonders stabil
- lange Ausführung

Heater Airing key

- extra strong
- long version



Bestell-Nr. Order-no.	Gesamtlänge x Schaftlänge x Einstecktiefe mm Total length x shaft x deepness mm
21-181000-0	34 x 20 x 10

**Standhahn-Mutternschlüssel
Teleskop**

- mit T-Griff
- Klaue bis SW 32
- verchromt

Wrench for water taps Telescopic

- with T-andle
- claw up to SW 32
- chromium plated



Bestell-Nr. Order-no.	Ausführung Execution
21-190000-9	ausziehbar/adjustable 275 - 455 mm

Waschtisch- & Armaturen-Schlüssel

- für Stockschrauben M 10
- Chrom-Vanadium

Washbasin sanitary wrench

- for hanger bolt M 10
- Chrom-Vanadium



Bestell-Nr. Order-no.	Ausführung Execution	Abmessung mm Size mm
21-182000-0	feststehend/fixed	17 x 19
21-183000-9	verstellbar/adjustable	17 x 19

Standhahn-Mutternschlüssel

- für Rechts- und Linksgang
- bis SW 32
- Chrom-Vanadium

Wrench for water taps

- right- & left hand drive
- up to SW 32
- Chrom-Vanadium



Bestell-Nr. Order-no.	Länge mm Length mm
21-191000-0	275

Universal-Ventilhalter

für Exzenter- und Standardventile

Universal valve holder

for excentric and standard valve



Bestell-Nr. Order-no.	für Ventile Ø mm for valves Ø mm
21-184000-0	30-45

Standhahn-Mutterschlüssel-Satz

- mit aufsteckbarer Klaue
- im Schlüssel SW 13
- mit vier Einsätzen
- Rechts- und Linksgang

Wrench for water taps, adjustable

- with adjustable jaw/claw
- tube end SW 13
- with four sockets
- right/left working



Bestell-Nr. Order-no.	Einsätze Sockets mm	Länge mm Length mm
21-191200-9	9, 10, 11, 14	360

Standhahn-Mutterschlüssel

- mit festem Drehgriff
- chromatisiert

Wrench for water taps

- with fixed handle
- chromatised



Bestell-Nr. Order-no.	Schlüsselweite mm Wrench size mm	Länge mm Length mm
21-191500-0	13	400

Aufsteckbare Klaue

- zu Standhahn-Mutterschlüssel
- rechts & links
- Antrieb SW 13

Slip on claw

- for water tabs
- right & left
- drive SW 13



Bestell-Nr. Order-no.	bis zu SW up to wrench size
21-191600-9	35

Standhahn-Mutternzange

Griffe isoliert

Water pump nut pliers

insulated handle



Bestell-Nr. Order-no.	Länge mm Length mm
21-193000-0	280

Kupferrohr-Biegezange

für weiches und halbhartes Kupferrohr

Pliers for bending copper tubes

for soft and medium hard copper tubes



Bestell-Nr. Order-no.	Rohr Ø mm Tube Ø mm
21-195010-0	10
21-195012-0	12
21-195014-0	14
21-195015-0	15
21-195016-0	16
21-195018-0	18
21-195022-0	22

Rohrbieger

- mit Gradscala bis 180°
- zum Biegen von Weichstahl, Weichkupfer & Messing
- lackiert

Tube bending wrench

- with raduated scale
- for bending soft steel- copper & brass tubes
- varnished



Bestell-Nr. Order-no.	zum Biegen von Rohr-Ø for bending tube-Ø
21-197000-9	6 (1/4") - 8 (5/16") - 10 (3/8")

Stufenschlüssel

- mit acht Stufen
- mit Schrauberklinge und Längsnute
- verchromt

Stepped key for radiation valves

- with eight steps
- with longitudinal slot and screw blade
- chrome plated



Bestell-Nr.
Order-no.

21-200000-9

Stufen
Steps

3/8"-1"

Länge mm
Length mm

105

Gasventil-Stufenschlüssel

- für Gas- und Wassergeräte
- 6-kant, mit Längsnute
- 1/2" Antrieb
- geeignet für alle namhaften Hersteller
- SW 12-13-14-15-19-1"-22-24
- DN 15/R 1/2" - DN 20/R 3/4" - DN 25/R 1"

**Stepped key for gas & water installation**

- 6 point
- with with longitudinal slot, 1/2" drive
- for all well known brands
- SW 12-13-14-15-19-1"-22-24
- DN 15/R 1/2" - DN 20/R 3/4" - DN 25/R 1"

Bestell-Nr.
Order-no.

21-204000-9

Länge mm
Length mm

90

Stufenschlüssel mit Längsnute

- vier Stufen
- zum Ein- und Ausschrauben von Gewindenippel
- 1/2" Antrieb
- verchromt

Stepped key for radiation valves

- four steps
- 1/2" drive
- chrome plated



Bestell-Nr.
Order-no.

21-202000-9

Stufen
Steps

3/8" - 1/2" - 3/4" - 1"

Länge mm
Length mm

90



Gas-/Wasser-Stufenschlüssel

- konisch
- drei Stufen
- verchromt

Gas step key

- conical
- three steps
- chrome plated



Bestell-Nr.
Order-no.

21-206000-9

Stufen
steps

1/2" - 3/4" - 1"

Länge mm
Length mm

90

Umsteckknarre 1/2"

- Handgriff isoliert
- Chrom-Vanadium

Ratchet 1/2", fixable

- insulated handle
- Chrom-Vanadium

Bestell-Nr.
Order-no.

21-212000-9-E

Länge mm
Length mm

250

**Stufenschlüssel**

- zum Ein- und Ausschrauben von Ventilgewindenippeln
- fünf Stufen
- Antrieb 18 mm Vierkant

Stepped key for valve nipples

- five steps
- 18 mm four point drive

Bestell-Nr.
Order-no.

21-209000-0

Stufen
Steps

3/8 - 1/2" - 3/4" - 1" - 1 1/4"

Länge mm
Length mm

160

**Stufenschlüssel-Satz**

- Ratsche 1/2" Antrieb
- Stufenschlüssel 3/8"-1"
- in Tasche
- verchromt

Stepped key set

- ratchet 1/2" drive
- stepped key 3/8"-1"
- in wallet
- chrome plated

Bestell-Nr.
Order-no.

21-214000-9

Stufen
Steps

3/8" - 1/2" - 3/4" - 1"

Länge mm
Length mm

250



Rohr-Schlauchschere

- zum Schneiden von Kunststoffen
- mit auswechselbarer Klinge
- Griffe tauchisoliert

Tube-Hose cutting shear

- for cutting of PVC
- with changeable cutting blade
- insulated handle



Bestell-Nr.
Order-no.

21-216000-9

bis Ø mm
up to Ø mm

22

Rohr-/Rohrverband-Schere

- mit Ratsche
- für Kunststoffrohr

Tube cutting shear

- with ratchet
- for cutting PVC tubes



Bestell-Nr.
Order-no.

21-217000-9

bis Ø mm
up to Ø mm

63

Rohr-Schlauchschere

- zum Schneiden von Kunststoffen
- mit Hammer
- auswechselbarer Klinge
- Griffe tauchisoliert

Tube-Hose cutting shear

- for cutting of PVC
- with hammer
- changeable blade
- insulated handle



Bestell-Nr.
Order-no.

21-216500-9

bis Ø mm
up to Ø mm

35

Bleirohr-Aufweitezange

- konische Backen

Inside pliers for lead pipe

- conical jaws



Bestell-Nr.
Order-no.

21-218000-0

Länge mm
Length mm

240

bis Ø Zoll
up to Ø inch

1 1/2"

Rohr-Einziehzange

- mit drei Unter- und zwei Oberbacken
- Griffe isoliert

Pipe crimper

- with three jaws below and two jaws above
- insulated handle



Bestell-Nr. Order-no.	Länge mm Length mm	Maultiefe mm jaws deepness mm
21-220000-0	250	30

Armaturenschlüssel MESSBA

- mit auswechselbaren Messingbacken
- Spannweite/-tiefe 83/50 mm
- mit Schnellverstellung
- zinkchromatisiert
- Spannhebel rot einbrennlackiert

Quick spanner wrench MESSBA

- with changeable brass jaws
- jaws widthness/-deepness 83/50 mm
- quick setting
- zinc-chromed
- setting arm red painted



Bestell-Nr. Order-no.	Länge mm Length mm
21-230000-0	300
21-231000-0	Ersatzbackensatz/spare jaw set

Sanitär-Armaturen-Rohrzange

- mit geraden Backen
- Schutzbacken wechselbar
- mit Muttersicherung
- Maul 90°
- Chrom-Vanadium

Sanitary fitting wrench

- with straight jaws
- jaws changable
- nut lock
- jaws 90°
- Chrom-Vanadium



Bestell-Nr. Order-no.	Länge mm Length mm	Spannweite mm Jaws width mm
21-228000-9	320	48

Schnellspann-Schlüssel ILSE

- mit Schnellverstellung
- Spannweite/-tiefe 75/45 mm
- zinkchromatisiert
- mit grober Zahnung
- Spannhebel rot einbrennlackiert

Quick spanner wrench ILSE

- quick setting
- jaws widthness/-deepness 75/45 mm
- zinc-chromed
- rough teethed
- setting arm red painted



Bestell-Nr. Order-no.	Länge mm Length mm
21-233000-0	260

Armaturenschlüssel mit Einstellrolle

- mit Kunststoffschutzbacken
- Spannweite/-tiefe bis 65/45 mm
- Spannhebel rot einbrennlackiert

Sanitary fitting wrench with adjustment roll

- with PVC protection jaws
- jaws widthness/-deepness 65/45 mm
- setting arm red painted



Bestell-Nr. Order-no.	Länge mm Length mm	
21-235000-0	275	
21-236000-0	PVC Ersatzbackensatz/PVC spare jaw set	

Rohrzange Original BLITZ

- mit Rolle
- schwarz einbrennlackiert

Pipe wrench Original BLITZ

- with roll
- black finish



Bestell-Nr. Order-no.	Länge mm Length mm	Spannweite mm Jaws width mm
21-240025-0	175	25
21-240038-0	225	38
21-240050-0	275	50
21-240064-0	305	64
21-240077-0	350	77

Syphonzange

- vierfach verstellbar
- für verchromte Armaturen
- mit Schutzbacken
- Griffe tauchisoliert

Drain adjustment pliers

- four positions
- for chromed fittings
- with protection jaws
- handle insulated



Bestell-Nr. Order-no.	Länge mm Length mm	Öffnung mm Opening mm
21-238000-9	230	70

Rohrzange Original BLITZ

- mit Rolle
- schwarz einbrennlackiert
- gekröpft

Pipe wrench Original BLITZ

- with roll
- black finish
- offset



Bestell-Nr. Order-no.	Länge mm Length mm	Spannweite mm Jaws width mm
21-241007-0	175	25
21-241009-0	225	38
21-241012-0	305	64



Ketten-Rohrzange MINI

- mit doppelter Zahnung

Chain pipe wrench MINI

- double teathed

Bestell-Nr.
Order-no.

21-242000-9

bis Rohr Ø Zoll
up to tube Ø inch

4



Ketten-Rohrzange

- mit doppelt gezahnten Backen

Chain pipe wrench

- with double teathed jaws

Bestell-Nr.
Order-no.

Artikel
Item

Rohr Ø Zoll
Pipe Ø inch

21-245002-0	Rohrzange/pipe wrench	1/4- 2
21-245003-0	Rohrzange/pipe wrench	1/2- 3
21-245004-0	Rohrzange/pipe wrench	3/4- 4
21-245006-0	Rohrzange/pipe wrench	1- 6
21-245008-0	Rohrzange/pipe wrench	1 1/2- 8
21-245012-0	Rohrzange/pipe wrench	2 -12
21-246002-0	Ersatzkette/spare chain	1/4 - 2
21-246003-0	Ersatzkette/spare chain	1/2 - 3
21-246004-0	Ersatzkette/spare chain	3/4 - 4
21-246006-0	Ersatzkette/spare chain	1 - 6
21-246008-0	Ersatzkette/spare chain	1 1/2 - 8
21-246012-0	Ersatzkette/spare chain	2 -12



Rohrzange SUPER DIN 5234 C

- mit S-Maul
- rot lackiert
- mit Stellschraube
- Chrom-Vanadium

Pipe wrench SUPER DIN 5234 C

- S-jaw type
- red varnished
- adjusting screw
- Chrom-Vanadium



Bestell-Nr. Order-no.	Länge Zoll Length inch	Öffnung mm Opening mm
21-250001-0	1	49
21-250015-0	1 1/2	68
21-250002-0	2	85
21-250003-0	3	120

Rohrzangen-Satz PROFI DIN 5234 C

- mit S-Maul
- dreiteilig
- Chrom-Vanadium

Pipe wrench set PROFI DIN 5234 C

- S-jaw type
- set of three pieces
- Chrom-Vanadium



Bestell-Nr. Order-no.	Abmessung Zoll size inch
21-251110-0	1 - 1 1/2 - 2

Rohrzange STANDARD

- mit S-Maul
- rot lackiert
- mit Stellschraube
- Chrom-Vanadium

Pipe wrench STANDARD

- S-jaw type
- red varnished
- adjusting screw
- Chrom-Vanadium



Bestell-Nr. Order-no.	Abmessung Zoll Size inch
21-250001-9	1
21-250015-9	1 1/2
21-250002-9	2

Rohrzangen-Satz STANDARD

- mit S-Maul
- dreiteilig
- Chrom-Vanadium

Pipe wrench set STANDARD

- S-jaw type
- set of three pieces
- Chrom-Vanadium



Bestell-Nr. Order-no.	Abmessung Zoll Size inch
21-251110-9	1 - 1 1/2 - 2

Schweden-Rohrzange DIN 5234 A

- 90°
- lackiert
- Chrom-Vanadium

Sweden Pipe wrench DIN 5234 A

- 90°
- varnished
- Chrom-Vanadium



Bestell-Nr. Order-no.	Abmessung Zoll Size inch	Öffnung mm Opening mm
21-252001-0	1	48
21-252015-0	1 1/2	65
21-252002-0	2	80
21-252003-0	3	115

Ventilstopfen mit Dreikantbügel

- schwarz

Basin plug with triangle ring

- black



Bestell-Nr. Order-no.	Ø mm
21-262029-0	29,5
21-262032-0	32,0
21-262038-0	38,5
21-262040-0	40,5
21-262043-0	43,5
21-262045-0	45,5
21-262048-0	48,5
21-262050-0	50,5

Ausgüßreiniger mit Holzstiel**Sink cleaner with wooden handle**

Bestell-Nr. Order-no.	Ø mm
21-260011-0	110
21-260014-0	140

Rohrreinigungswelle STANDARD

- aus verzinktem Federstahldraht
- mit gedrehter Kralle Ø 25 mm
- mit Buchenholz Handgriff

Spiral pipe cleaner STANDARD

- zinc plated spring steel wire
- with strong claw Ø 25 mm
- wooden handle



Bestell-Nr. Order-no.	Länge m Length m	Ø mm
21-265003-0	3	6
21-265005-0	5	9
21-265010-0	10	9

Rohrreinigungswelle PLUMBER

- doppelagig
- mit fester kleiner Kralle und verstellbarem Handgriff

Spiral pipe cleaner PLUMBER

- two layer
- with fixed small claw and adjustable handle



Bestell-Nr. Order-no.	Länge m Length m	Ø mm Ø mm
21-268037-0	3	7
21-268057-0	5	7
21-268017-0	10	7
21-268031-0	3	10
21-268051-0	5	10
21-268011-0	10	10

Rohrreinigungswelle PROFI

- doppelagig gewickelt
- mit Stahlkralle und hochwertiger Kurbel
- Kupplung aus Messing

Spiral pipe cleaner PROFI

- two-layer
- with steel claw and high quality crank
- brass coupler, plastic handle



Bestell-Nr. Order-no.	Länge m Length m	Ø mm Ø mm
21-270005-0	5	12
21-270010-0	10	12

Rohrreinigungswelle mit Kurbel

- mit Stahlkralle
- Kupplung aus verzinktem Stahl

Spiral pipe cleaner with crank

- with steel claw
- crank coupler zinc plated



Bestell-Nr. Order-no.	Länge m Length m	Ø mm Ø mm	Detail Detail
21-269005-0	5	6	-
21-269010-0	10	8	doppelagig/two-layer

Rohrreinigungsgerät mit Handgriff

- stabiles Kunststoffgehäuse
- zusätzlich mit 6-kant zum Einspannen in elektrische Bohrmaschine
- arretierbar auf jede Länge

Spiral tube cleaning equipment

- strong plastic case
- with hex-connector usable in drilling machine
- adjustable on different length



Bestell-Nr. Order-no.	Länge m Length m	Ø mm Ø mm	für Rohre Ø mm for tubes Ø mm
21-272000-0	7,5	8,0	30 - 50

Wasserpumpenzange DIN/ISO 8976

- durchgestecktes Gewerbe
- mit Klemmschutz
- rot lackiert
- schlanker Kopf
- Griffe tauchisoliert

Water-pump pliers DIN/ISO 8976

- box joint
- with clench protector
- red varnished
- slim head
- handle insulated



Bestell-Nr. Order-no.	Länge mm Length mm	Öffnung mm Opening mm
21-275018-0	180	26
21-275025-0	250	33
21-275030-0	300	45

**Wasserpumpenzange RILLEN
DIN/ISO 8976**

- Griffe isoliert
- verchromt
- Chrom-Vanadium

Water-pump pliers DIN/ISO 8976

- insulated handle
- chrome-plated
- Chrom-Vanadium



Bestell-Nr. Order-no.	Länge mm Length mm
21-279025-0	250

**Universalzange FastGrip
DIN/ISO 8976**

- Super-Fein-Verstellung per Knopfdruck
- doppelte Rastloch-Abstützung
- PVC isoliert

**Universal-Pliers FastGrip
DIN/ISO 8976**

- with stepless super - fine adjustment by knob push
- insulated handle



Bestell-Nr. Order-no.	Länge mm Length mm
21-277018-0	180
21-277025-0	250
21-277030-0	300

S-Maul Rohr-Wasserpumpenzange

- mit Skala und Greifschutz
- rot lackiert
- tauchisolierte Griffe

Water-pump pliers with S-jaw

- head with scale
- with grab protector
- red varnished
- handle insulated



Bestell-Nr. Order-no.	Länge mm Length mm
21-280025-0	250





Flachmaul-Zange POWER-GRIP

- mit Druckknopf-Schnellverstellung
- Griffe rot tauchisoliert
- verchromt

Pliers POWER-GRIP

- flat jaws fast adjustable with press button
- red insulated handle
- chromium plated



Bestell-Nr. Order-no.	Länge mm Length mm	Maulweite mm Opening mm
21-281018-0	180	36
21-281025-0	250	46
21-281030-0	300	60

Original Schnellspannzange

- durchgesteckt
- fünffache Schnellverstellung
- mit Klemmschutz
- verchromt
- Chrom-Vanadium

Water-pump pliers with spring

- box joint
- five steps quick setting
- with grab protector
- chromium plated
- Chrom-Vanadium



Bestell-Nr. Order-no.	Länge mm Length mm
21-285025-0	250
21-285037-0	375
21-286025-0	250 isoliert/insulated handle

Rollgabelschlüssel

- verchromt
- Chrom-Vanadium

Adjustable wrench

- chromium plated
- Chrom-Vanadium



Bestell-Nr. Order-no.	Länge mm Length mm	Maulweite mm Opening mm
21-290018-9	150	18
21-290023-9	200	23
21-290027-9	250	27
21-290033-9	300	33
21-290043-9	375	43
21-290060-9	450	60

Rollgabelschlüssel mit Skala

- isolierter Handgriff
- verchromt
- Chrom-Vanadium

Adjustable wrench with scale

- insulated handle
- chromium plated
- Chrom-Vanadium



Bestell-Nr. Order-no.	Abmessung mm Size mm	Maulweite mm Opening mm
21-292018-9	150	18
21-292023-9	200	23
21-292027-9	250	27
21-292033-9	300	33

Rollgabelschlüssel ECO

- Griff blau isoliert
- verchromt
- Chrom-Vanadium

Adjustable wrench ECO

- handle blue insulated
- chromium plated
- Chrom-Vanadium



Bestell-Nr. Order-no.	Länge mm Length mm	Maulweite mm Opening mm
21-291018-9	150	18
21-291023-9	200	23
21-291027-9	250	27
21-291033-9	300	33
21-291043-9	375	43
21-291060-9	450	60

Nietzange PROFI -Ausführung

- mit vier auswechselbaren Mundstücken

Rivetting pliers, professional quality

- with four exchangeable inserts



Bestell-Nr. Order-no.	Mundstücke mm Inserts mm
21-300000-9	2,4 - 3,0 - 4,0 - 4,8

Kombinationszange ISO 5746

- mit Schneide
- soft grip isoliert
- verchromt

Bestell-Nr.
Order-no.[21-302018-9](#)[21-302020-9](#)Länge mm
Length mm

180

200

**Combination pliers ISO 5746**

- with cutting edge
- soft grip handle
- chromium plated

Elektriker-Seitenschneider ISO 5749

- mit Abisolierfunktion 1,5 + 2,5 mm²
- für mittelharten Draht
- soft grip isoliert
- verchromt

Bestell-Nr.
Order-no.[21-304016-9](#)Länge mm
Length mm

160

**Side cutter for electricians ISO 5749**

- with wire stripping function Ø 1,5 + 2,5 mm²
- for medium hard wire cutting
- soft grip handle
- chromium plated

Seitenschneider ISO 5749

- für mittelharten Draht
- soft grip isoliert
- verchromt

Bestell-Nr.
Order-no.[21-306016-9](#)[21-306018-9](#)Länge mm
Length mm

160

180

**Side cutter ISO 5749**

- for medium hard wire cutting
- soft grip handle
- chromium plated

Kraftseitenschneider ISO 5749

- für harten Draht
- soft grip isoliert
- verchromt

Bestell-Nr.
Order-no.[21-308020-9](#)Länge mm
Length mm

200

**Diagonal cutter ISO 5749**

- for hard wire cutting
- soft grip handle
- chromium plated

Telefonzange ISO 5745

- mit Drahtabschneider
- gerade
- soft grip isoliert
- verchromt

Bestell-Nr.
Order-no.[21-310016-9](#)[21-310020-9](#)Länge mm
Length mm

160

200

**Telephone pliers ISO 5745**

- with wire cutter
- straight
- soft grip handle
- chromium plated

Telefonzange ISO 5745

- 45° gebogen
- mit Drahtabschneider
- soft grip isoliert
- verchromt

Bestell-Nr.
Order-no.

21-312020-9

Länge mm
Length mm

200

**Telephone pliers ISO 5745**

- 45° bent
- with wire cutter
- soft grip handle
- chromium plated

Abisolierzange

- mit Stellschraube
- soft grip isoliert
- verchromt

Bestell-Nr.
Order-no.

21-314016-9

Länge mm
Length mm

160

**Stripping pliers**

- with adjusting screw
- soft grip handle
- chromium plated

Zangensatz in Tasche, dreiteilig

Satz bestehend aus:

- Kombizange 180 mm
- Telefonzange 200 mm
- Seitenschneider 160 mm

Pliers set of three pieces, in wallet

set consisting of:

- Combination plier 180 mm
- Telephone plier 200 mm
- Side Cutter 160 mm

Bestell-Nr.
Order-no.

21-320016-9

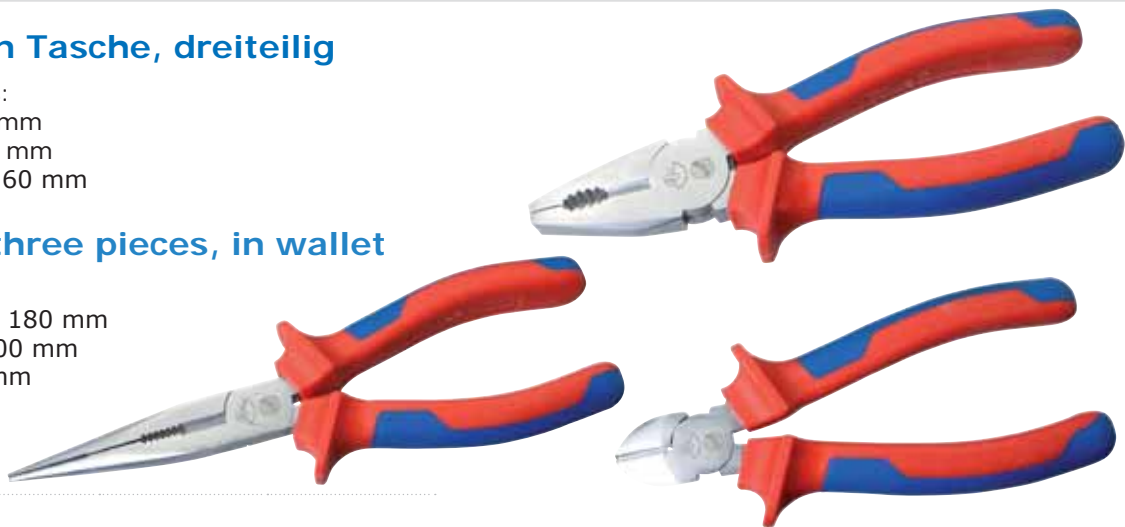
**Vornschneider ISO 5478**

- für harten Draht
- lackiert
- Kopf blank
- Griffe isoliert

Front cutter ISO 5478

- for hard wire
- polished head
- handle red insulated



Best.-Nr.
Order-no.

21-337016-0

Länge mm
Length mm

160

21-337018-0

180

Vornschneider MOUSTACHE

- für harten Draht
- lackiert
- Kopf blank
- Griffe isoliert

Front cutter MOUSTACHE

- for hard wire
- polished head
- handle red insulated



Best.-Nr.
Order-no.

21-337116-0

Länge mm
Length mm

160

Elektronik-Seitenschneider

- aufgelegtes Gewerbe
- mit Feder
- Griffe isoliert
- verchromt

Electronic side cutter

- lap joint
- with spring
- insulated handle
- chromium plated

Bestell-Nr.
Order-no.**21-351012-9**Länge mm
Length mm

120

**Elektronik-Vornschnneider**

- aufgelegtes Gewerbe
- mit Feder
- Griffe isoliert
- verchromt

Electronic front cutter

- lap joint
- with spring
- insulated handle
- chromium plated

Bestell-Nr.
Order-no.**21-353012-9**Länge mm
Length mm

120

**Elektronik-Kettenzange**

- gerade
- aufgelegtes Gewerbe
- mit Feder
- Griffe isoliert
- verchromt

Electronic pliers, oval-pointed

- straight
- lap joint
- with spring
- insulated handle
- chromium plated

Bestell-Nr.
Order-no.**21-359012-9**Länge mm
Length mm

120

**Elektronik-Rundzange**

- aufgelegtes Gewerbe
- mit Feder
- Griffe isoliert
- verchromt

Electronic pliers, round

- lap joint
- with spring
- insulated handle
- chromium plated

Bestell-Nr.
Order-no.**21-357012-9**Länge mm
Length mm

120



Elektronik-Kettenzange

- gebogen
- aufgelegtes Gewerbe
- mit Feder
- Griffe isoliert
- verchromt

Bestell-Nr.
Order-no.

21-359512-9

Länge mm
Length mm

120

**Electronic pliers, oval-pointed**

- bent
- lap joint
- with spring
- insulated handle
- chromium plated

Elektronik-Kombizange

- aufgelegtes Gewerbe
- mit Feder
- Griffe isoliert
- verchromt

Bestell-Nr.
Order-no.

21-360012-9

Länge mm
Length mm

120

**Electronic combination pliers**

- lap joint
- with spring
- insulated handle
- chromium plated

Elektronik-Flachzange

- aufgelegtes Gewerbe
- mit Feder
- Griffe isoliert
- verchromt

Bestell-Nr.
Order-no.

21-363012-9

Länge mm
Length mm

120

**Electronic pliers, flat**

- lap joint
- with spring
- insulated handle
- chromium plated



Kombinationszange ISO 5746

- VDE ähnlich isoliert
- verchromt

Combination pliers ISO 5746

- VDE similar insulated
- chromium plated

Bestell-Nr.
Order-no.

21-322018-0

21-322020-0

Länge mm
Length mm

180

200

**Seitenschneider ISO 5749**

- für PIANO-Draht
- VDE ähnlich isoliert
- verchromt

Side cutter ISO 5749

- for PIANO wire
- VDE similar insulated
- chromium plated

Bestell-Nr.
Order-no.

21-323016-0

21-323018-0

Länge mm
Length mm

160

180

**Kraftseitenschneider ISO 5749**

- für PIANO Draht
- VDE ähnlich isoliert
- verchromt

Diagonal cutter ISO 5749

- for PIANO wire
- VDE similar insulated
- chromium plated

Bestell-Nr.
Order-no.

21-325016-0

21-325020-0

Länge mm
Length mm

160

200

**Telefonzange ISO 5745**

- gerade
- mit Schneide
- VDE ähnlich isoliert
- verchromt

Telephone pliers ISO 5745

- straight
- with cutting edge
- VDE similar insulated
- chromium plated



Bestell-Nr.
Order-no.

21-326020-0

Länge mm
Length mm

200



Telefonzange ISO 5745

- 45° gebogen
- mit Brennerloch
- mit Schneide
- VDE ähnlich isoliert
- verchromt

Telephone pliers ISO 5745

- 45° bent
- VDE similar insulated
- chromium plated

Bestell-Nr.
Order-no.

21-327020-0

Länge mm
Length mm

200

**Abisolierzange,
automatische Einstellung**

- VDE ähnlich isoliert
- vernickelt

Automatic stripping pliers

- VDE similar insulated
- nickel plated

Bestell-Nr.
Order-no.

21-330012-0

Für Draht Ø mm
For wire Ø mm

0,3-1,2

21-330050-0

0,5-5,0

**Scherenzange ORIGINAL FIT**

- Griffe isoliert
- Kopf poliert

Pliers ORIGINAL FIT

- insulated handle
- head polished



Bestell-Nr.
Order-no.

21-332020-0

Länge mm
Length mm

200

Diagonalschneider für Stahldraht

mit tauchisolierten Griffen

Diagonal cutter for hard wire

with insulated handle



Bestell-Nr.
Order-no.

21-334020-0

Isolierung
Insulation

gelb/yellow

Länge mm
Length mm

200

21-334026-0

rot/red

260

Hebel-Seitenschneider ISO 5749

lackiert

Lever side cutting nipper ISO 5749

japanned

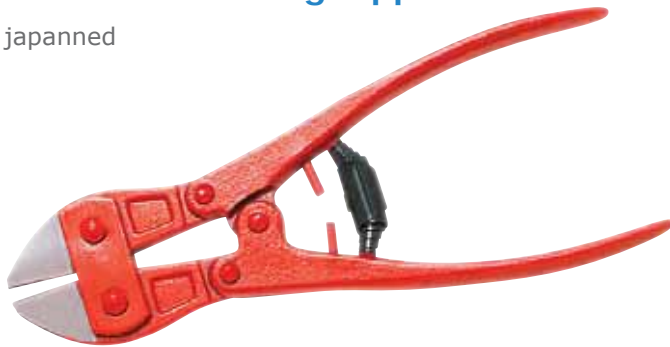

Bestell-Nr. Order-no.	Länge mm Length mm
21-340022-0	225
21-340026-0	260

Elektronik-Seitenschneider

- durchgestecktes Gewerbe
- blank poliert
- mit Feder
- Griffe isoliert

Electronic side cutter

- box joint
- fine polished
- with spring
- insulated handle



Bestell-Nr. Order-no.	Länge mm Length mm
21-350011-0	115

Hebel-Vornschneider ISO 5748

- lackiert

Lever cutting nipper ISO 5748

- japanned



Bestell-Nr. Order-no.	Länge mm Length mm
21-342021-0	210
21-342023-0	230

Elektronik-Vornschneider

- durchgestecktes Gewerbe
- blank poliert
- mit Feder
- Griffe isoliert

Electronic front cutter

- box joint
- fine polished
- with spring
- insulated handle



Bestell-Nr. Order-no.	Länge mm Length mm
21-352011-0	115

Elektronik-Schrägschneider

- durchgestecktes Gewerbe
- blank poliert
- mit Feder
- Griffe isoliert

Electronic front cutter

- oblique head
- box joint
- fine polished
- with spring
- insulated handle



Bestell-Nr. Order-no.	Länge mm Length mm
21-354011-0	115

Elektronik-Rundzange

- durchgestecktes Gewerbe
- blank poliert
- mit Feder
- Griffe isoliert

Electronic pliers, round

- box joint
- fine polished
- with spring
- insulated handle



Bestell-Nr. Order-no.	Länge mm Length mm
21-356011-0	115

Elektronik-Kettenzange

- durchgestecktes Gewerbe
- blank poliert
- mit Feder
- Griffe isoliert

Electronic pliers, oval-pointed

- box joint
- fine polished
- with spring
- insulated handle



Bestell-Nr.
Order-no.

21-358011-0

Länge mm
Length mm

115

Elektronik-Flachzange

- durchgestecktes Gewerbe
- blank poliert
- mit Feder
- Griffe isoliert

Electronic pliers, flat

- box joint
- fine polished
- with spring
- insulated handle



Bestell-Nr.
Order-no.

21-362011-0

Länge mm
Length mm

115



Spezial-Montagezange

- zum Montieren von hufeisenförmigen Ringen
- mit Blattfeder
- verchromt
- Chrom-Vanadium

Horseshoe lock special circlip pliers

- for mounting horseshoe rings
- with spring
- chromium plated
- Chrom-Vanadium



Bestell-Nr.
Order-no.

21-370000-0

Länge mm
Length mm

180

Sicherungszange DIN 5256 D

- innen
- gebogen
- verchromt
- Chrom-Vanadium

Circlip pliers DIN 5256 D

- internal
- bent
- chromium plated
- Chrom-Vanadium



Bestell-Nr.
Order-no.

21-373001-0

Länge mm
Length mm

130

Kurzbezeichnung
Short code

J 01

für Ringe Ø
for rings Ø

3- 10

21-373011-0

130

J 11

10- 25

21-373021-0

180

J 21

19- 60

21-373031-0

220

J 31

40-100

21-373041-0

310

J 41

85-165

Sicherungszange DIN 5256 C

- innen
- gerade
- verchromt
- Chrom-Vanadium

Circlip pliers DIN 5256 C

- internal
- straight
- chromium plated
- Chrom-Vanadium



Bestell-Nr.
Order-no.

21-371000-0

Länge mm
Length mm

130

Kurzbezeichnung
Short code

J 0

für Ringe Ø
for rings Ø

3- 10

21-371001-0

130

J 1

10- 25

21-371002-0

180

J 2

19- 60

21-371003-0

220

J 3

40-100

21-371004-0

310

J 4

85-165

Sicherungszange DIN 5254 A

- aussen
- gerade
- verchromt
- Chrom-Vanadium

Circlip pliers DIN 5254 A

- external
- straight
- chromium plated
- Chrom-Vanadium



Bestell-Nr.
Order-no.

21-375000-0

Länge mm
Length mm

130

Kurzbezeichnung
Short code

A 0

für Ringe Ø
for rings Ø

3- 10

21-375001-0

130

A 1

10- 25

21-375002-0

180

A 2

19- 60

21-375003-0

220

A 3

40-100

21-375004-0

310

A 4

85-165



Sicherungszange DIN 5254 B

- aussen
- gebogen
- verchromt
- Chrom-Vanadium

Circlip pliers DIN 5254 B

- external
- bent
- chromium plated
- Chrom-Vanadium



Bestell-Nr. Order-no.	Länge mm Length mm	Kurzbezeichnung Short code	für Ringe Ø for rings Ø
21-377001-0	130	A 01	3- 10
21-377011-0	130	A 11	10- 25
21-377021-0	180	A 21	19- 60
21-377031-0	220	A 31	40-100
21-377041-0	310	A 41	85-165

Dachdecker-Beißzange

- Kopf plan geschliffen
- rot lackiert
- feine Wate

Special tiler pincer

- head flat grinded
- red japanned
- fine edge



Bestell-Nr.
Order-no. [21-381000-0](#) Länge mm
Length mm 220



Dachdecker-Spezialzange

Kopf plan geschliffen, rot lackiert, feine Wate

Special tiler pincer

head flat grinded, red japanned



Bestell-Nr.
Order-no. [21-380000-0](#) Länge mm
Length mm 220

Rinnenhalter-Biegezange mit Rolle

- Kopf chromatisiert
- Schenkel rot lackiert
- mit schwarzen Handgriffen
- für Rinnen bis 8 mm Stärke und 50 mm Breite

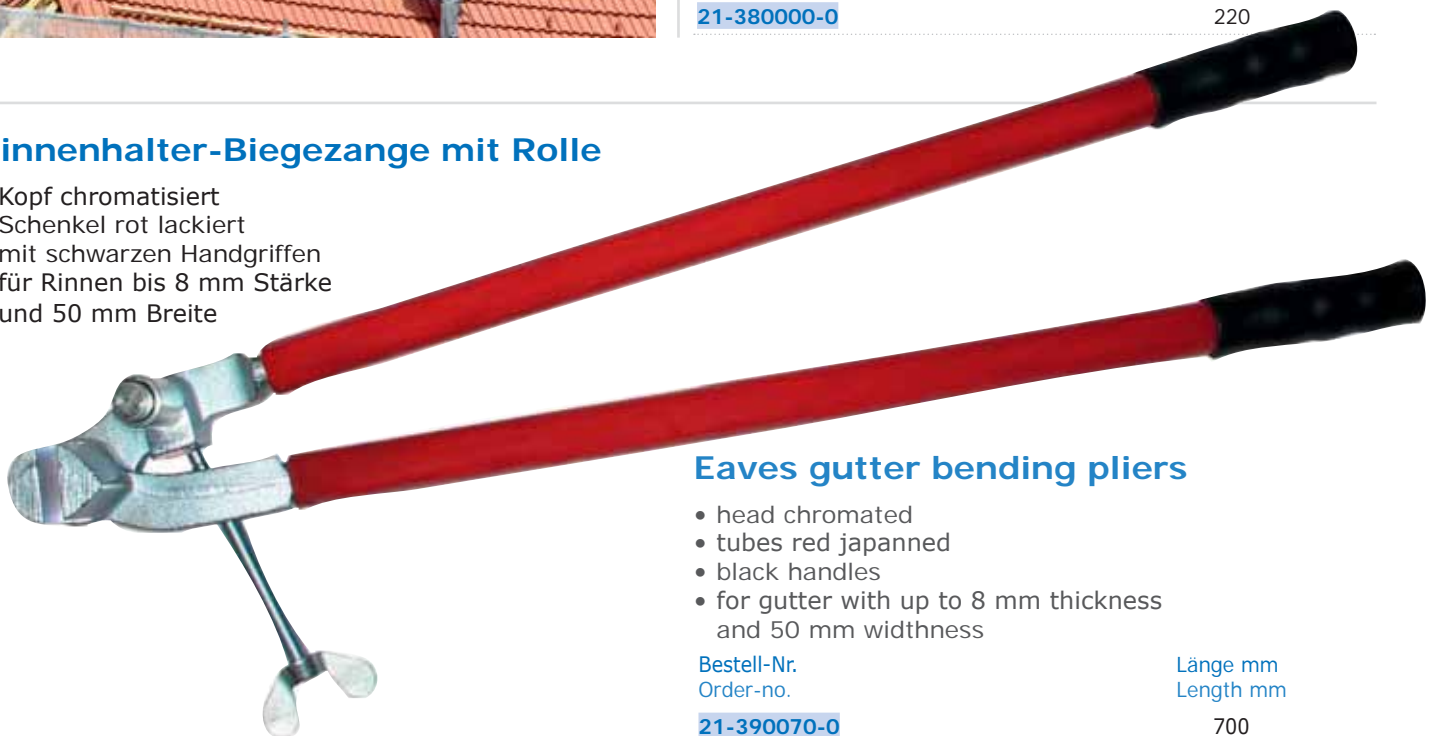

Eaves gutter bending pliers

- head chromated
- tubes red japanned
- black handles
- for gutter with up to 8 mm thickness and 50 mm widthness

Bestell-Nr.
Order-no. [21-390070-0](#) Länge mm
Length mm 700

Rabitzzange ISO 9242

- Kopf poliert
- Schneide induktiv gehärtet
- lackiert

Tower pincer ISO 9242

- polished head
- edges inductive hardened
- black japanned



Bestell-Nr. Order-no.	Länge mm Length mm	Ausführung execution
21-383022-0	220	
21-383025-0	250	
21-383028-0	280	
21-384022-0	220	isolierte Griffe/insulated handle
21-384025-0	250	isolierte Griffe/insulated handle
21-384028-0	280	isolierte Griffe/insulated handle

Revolverlochzange STANDARD

- vernickelt
- isolierte Griffe

Revolving punch pliers STANDARD

- nickel plated
- insulated handle



Bestell-Nr. Order-no.	Für Lochung Ø mm For holes Ø mm	Länge mm Length mm
21-392000-0	2,0/2,5/3,0/3,5/4,0/4,5	220

Beißzange ISO 9243

- Kopf poliert
- Schneide induktiv gehärtet
- lackiert

Carpenter's pincer ISO 9243

- polished head
- edges inductive hardened
- black japanned

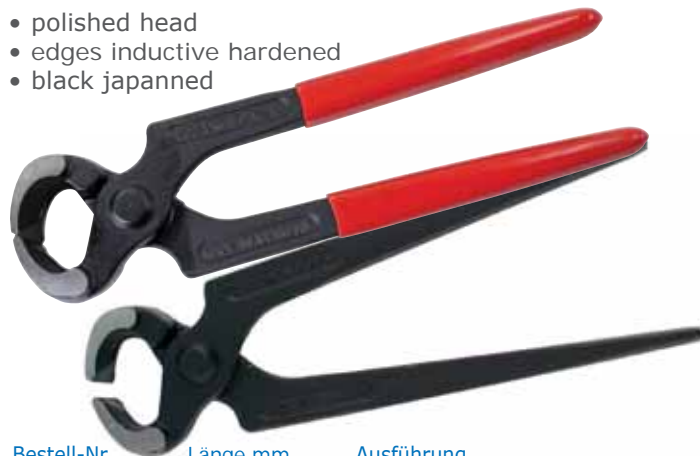

Bestell-Nr. Order-no.	Länge mm Length mm	Ausführung execution
21-386016-0	160	
21-386018-0	180	
21-386020-0	200	
21-386025-0	250	
21-387016-0	160	isolierte Griffe/insulated handle
21-387018-0	180	isolierte Griffe/insulated handle
21-387020-0	200	isolierte Griffe/insulated handle
21-387025-0	250	isolierte Griffe/insulated handle

Revolverlochzange PROF I

- mit Hebelübersetzung
- vernickelt
- isolierte Griffe

Revolving punch pliers PROF I

- with lever transmission
- nickel plated
- insulated handle



Bestell-Nr. Order-no.	Für Lochung Ø mm For holes Ø mm	Länge mm Length mm
21-393023-0	2,0/2,5/3,0/3,5/4,0/4,5	220

Revolverlochzange SIMPLE

- mit sechs Pfeifen
- 220 mm

Revolving punch pliers SIMPLE

- with six tubes
- 220 mm



Bestell-Nr. Order-no.	Für Lochung Ø mm For holes Ø mm	Ausführung Finishing
21-395022-0	2,0/2,5/3,0/3,5/4,0/4,5	poliert/polished
21-396022-0	2,0/2,5/3,0/3,5/4,0/4,5	vernickelt/nickel plated

Ösenzange SWITCH

- vernickelt
- mit drei Paar Ösenstempel

Eyelet pliers SWITCH

- nickel plated
- with three pairs of eyelet dies



Bestell-Nr. Order-no.	Länge mm Length mm
21-399000-0	205
21-399500-0	Ösenstempelsatz/eyelet die set 4,5/5,0/5,5

Revolverloch- & Ösenzange

- mit Kunststoffgriffen
- vernickelt
- 230 mm

Revolving punch & Eyelet pliers

- with strong PVC handle
- nickel plated
- 230 mm



Bestell-Nr. Order-no.	für Lochung Ø mm For holes Ø mm	für Ösen Ø mm for eyelets Ø mm
21-397022-0	4,0/4,5/5,0	4,5/5,0/5,5

Hebel-Revolverlochzange

- vernickelt
- für ovale, längliche oder rechteckige Lochungen
- mit großem Stahlamboss
- mit Kunststoffgriffen
- 250 mm

Lever-Revolving punch pliers

- nickel plated
- for oval, long, and square punching
- with large steel anvil
- with PVC handle
- 250 mm



Bestell-Nr. Order-no.	Lochungen Ø mm Punching Ø mm
21-400000-0	oval 5,7 x 3,8/4,6 x 3,0/6,3 x 3,5/7,3 x 4,3 länglich/long hole 7,8 x 3,0 rechteckig/square 6,0 x 3,0

Ösen

SB-Pack 100 Stück

Eyelets

box of 100 pieces



Bestell-Nr. Order-no.	Ø mm
21-398045-0	4,5
21-398050-0	5,0
21-398055-0	5,5



Schaffner-Kontrollzange

- vernickelt
- Faconlochung 1-20

Ticket punch pliers

- nickel plated
- with selectable punch 1-20

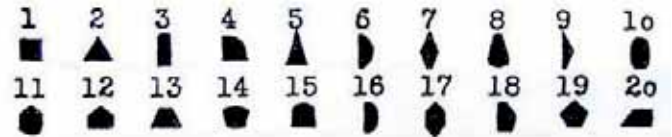

Bestell-Nr. Order-no.	Länge mm Length mm
21-4130..	120
21-4131..	145
21-4132..	165

Schaffner-Kontrollzange STANDARD

mit Runddorn Ø 3 mm

Ticket punch pliers

with round hole Ø 3 mm



Bestell-Nr. Order-no.	Länge mm Length mm	Ausführung Finishing
21-410012-0	120	poliert/polished
21-410014-0	145	poliert/polished
21-410016-0	165	poliert/polished
21-411012-0	120	vernickelt/nickel plated
21-411014-0	145	vernickelt/nickel plated
21-411016-0	165	vernickelt/nickel plated

Schaffner-Kontrollzange

- vernickelt
- Faconlochung 21-200

Ticket punch pliers

- nickel plated
- with selectable punch 21-200



Bestell-Nr. Order-no.	Länge mm Length mm
21-4140..	120
21-4141..	145
21-4142..	165



Bleiplombenzange STANDARD

- ganz poliert

Lead seal pliers STANDARD

- all polished



Bestell-Nr. Order-no.	Länge mm Length mm	Für Plomben Ø mm For seals Ø mm
21-418013-0	130	8
21-418015-0	150	9
21-418017-0	170	10
21-418019-0	190	11

**Stempel für Plombenzangen****Spare punches for lead seal pliers**

Bestell-Nr. Order-no.	Ausführung Execution	Plomben Ø mm Seals Ø mm
21-421008-0	standard punch	8
21-421009-0	standard punch	9
21-421010-0	standard punch	10
21-421011-0	standard punch	11
21-421008-1	1-stellig/digit	8
21-421008-2	2-stellig/digit	8
21-421008-3	3-stellig/digit	8
21-421008-4	4-stellig/digit	8
21-421008-5	5-stellig/digit	8
21-421009-1	1-stellig/digit	9
21-421009-2	2-stellig/digit	9
21-421009-3	3-stellig/digit	9
21-421009-4	4-stellig/digit	9
21-421009-5	5-stellig/digit	9
21-421010-1	1-stellig/digit	10
21-421010-2	2-stellig/digit	10
21-421010-3	3-stellig/digit	10
21-421010-4	4-stellig/digit	10
21-421010-5	5-stellig/digit	10
21-421011-1	1-stellig/digit	11
21-421011-2	2-stellig/digit	11
21-421011-3	3-stellig/digit	11
21-421011-4	4-stellig/digit	11
21-421011-5	5-stellig/digit	11

Bleiplombenzange EXTRA

- vernickelt
- isolierte Griffe

Lead seal pliers

- nickel plated
- handle insulated



Bestell-Nr. Order-no.	Länge mm Length mm	Für Plomben Ø mm For seals Ø mm
21-420013-0	130	8
21-420015-0	150	9
21-420017-0	170	10
21-420019-0	190	11

Presszange für isolierte Kabelschuhe

- mit Abisoliervorrichtung
- Drahtabschneider und Schraubenabschneider mit Gewinde
- Griffe isoliert

Crimping pliers

- for insulated terminals
- with wire and screw cutter, with thread
- insulated handle



Bestell-Nr. Order-no.	Pressbereich mm ² Crimping area mm ²	Abisolierbereich mm ² Stripping area mm ²	Länge mm Length mm
21-425022-9	0,25-6,0	0,5-6,0	230

Aderendhülsenzange

- für Trapezpressungen
- mit Abisolier- und Schneidvorrichtung
- isolierte Griffe
- verchromt

Crimping pliers

- for trapeze crimping
- with stripping and cutting device
- insulated handle
- chrome-plated



Bestell-Nr. Order-no.	Leiterquerschnitt mm ² Conductor cross section mm ²	Länge mm Length mm
21-427025-0	0,25-2,5	155
21-427016-0	0,50-16,0	220
21-427035-0	10,0-35,0	220

Kabelschuhpresszange PROFi

für isolierte und unisolierte Kabelschuhe und Verbinder

- mit Abisoliervorrichtung
- Schraubenabschneider mit Gewinde
- Griffe isoliert

Crimping pliers

for insulated and non insulated terminals

- with screw cutter
- with thread
- insulated handle



Bestell-Nr. Order-no.	Pressbereich mm ² Crimping area mm ²	Abisolierbereich mm ² Stripping area mm ²	Länge mm Length mm
21-426023-9	0,5-6,0	0,5-6	230



Aderendhülsen/Crimp-Zange

- mit stirnseitig angeordnetem Crimpprofil
- vernickelt
- isolierte Griffe

Crimping pliers

- on the face side located crimp profile
- nickel plated
- insulated handle



Bestell-Nr. Order-no.	Pressbereich mm ² Crimping area mm ²	Länge mm Length mm
21-428000-0	0,14-6,0	190

Press-Gripzange

- mit Abisoliervorrichtung
- für isolierte Kabelschuhe und Verbinder
- mit Schnelllösehebel
- vernickelt

Crimping pliers

- with stripping system
- for insulated terminals and connectors
- with quick opening level
- nickel plated



Bestell-Nr. Order-no.	Pressbereich mm ² Crimping area mm ²	Länge mm Length mm
21-430021-9	0,5-6,0	210

Ratschen-Presszange

mit Hebelübersetzung für isolierte Kabelschuhe und Verbinder

- mit Zahnrastgewerbe
- mit isolierten Griffen

Crimping pliers

with lever transmission ratchet system

- for insulated terminals
- with insulated handle



Bestell-Nr. Order-no.	Pressbereich mm ² Crimping area mm ²	Länge mm Length mm
21-429025-9	0,25-6,0	250

Kabelschuh-Sortiment

- Handpreßzange für isolierte Kabelschuhe 1,5-6,0 mm²
- 500 Stück Kabelschuhe
- im Tragekasten

Assortment of cable lugs in box

- set consisting of 500 pieces
- including crimping plier



Bestell-Nr. Order-no.
21-432000-9



**Schraubwerkzeuge**

Schraubendreher	58-65, 69
Feinmechanik	79-80
Drill Bindewerkzeug	80-81
Adaptersatz	81
BIT-Schraubeinsätze	81-87
Steckgriffe	87
Schlauchschellendreher	88
Magnethalter	88
Steckschlüssel	89
Stiftschlüssel	90-99

Screwing tools

Screwdrivers	58-65, 69
Fine mechanic	79-80
Wire bending drill	80-81
Adapter set	81
BIT-inserts	81-87
BIT handles	87
Hose clip screwdrivers	88
Magnetic holders	88
Socket nutdrivers	89
Allen keys	90-99

**Spannungstester**

Testboy	65-66
Spannungsprüfer	66-68
Auto-Stromprüfer	68
Digital-Multimeter	69

Voltage/Power Testers

Testboy	65-66
Voltage testers	66-68
Car light testers	68
Digital-Multimeter	69

**Elektrobedarf**

Kabelbinder	70
Einziehhilfen	71-72
ORIGINAL Jokari	73-76
Kabelmesser	76-78
Kabeltrennmesser	77
KABIFIX Abisolierer	78

Electro demand

Cable ties	70
Draw-in supports	71-72
ORIGINAL Jokari	73-76
Cable knives	76-78
Hacking knife	77
KABIFIX cable stripper	78

**Kreuzschlitz-Schraubendreher
ISO 8764**

- mit verchromter Klinge Chrom-Vanadium
- schwarze Spitze
- mit 2-Komponenten-Griff

**Screwdriver for PHILLIPS screws
ISO 8764**

- blade chromium plated and Chrom-Vanadium
- with black tip
- with 2-component handle



Bestell-Nr. Order-no.	Abmessung PH Size PH	Klingenlänge mm Blade length mm	Gesamtlänge mm Total length mm
22-100001-0	0	60	145
22-100002-0	1	80	180
22-100003-0	1	300	400
22-100004-0	2	100	220
22-100005-0	2	300	420
22-100006-0	3	150	270

**Schlitz-Werkstatt-Schraubendreher
ISO 2380**

- mit verchromter Klinge Chrom-Vanadium
- schwarze Spitze
- mit 2-Komponenten-Griff

**Slotted Workshop screwdriver
ISO 2380**

- blade chromium plated and Chrom-Vanadium
- with black tip
- with 2-component handle



Bestell-Nr. Order-no.	Abmessung mm Size mm	Klingenlänge mm Blade length mm	Gesamtlänge mm Total length mm
22-102005-0	6,0	100	200
22-102008-0	6,5	150	270
22-102009-0	8,0	175	290
22-102010-0	10,0	200	320
22-102011-0	12,0	250	370

**Pozidriv-Schraubendreher
ISO 8764**

- mit verchromter Klinge Chrom-Vanadium
- schwarze Spitze
- mit 2-Komponenten-Griff

**Screwdriver for Pozidriv screws
ISO 8764**

- blade chromium plated and Chrom-Vanadium
- with black tip
- with 2-component handle



Bestell-Nr. Order-no.	Abmessung PZ Size PZ	Klingenlänge mm Blade length mm	Gesamtlänge mm Total length mm
22-101006-0	0	60	145
22-101008-0	1	80	180
22-101010-0	2	100	220
22-101015-0	3	150	270

**Schlitz-Elektriker-Schraubendreher
ISO 2380**

- mit verchromter Klinge Chrom-Vanadium
- schwarze Spitze
- mit 2-Komponenten-Griff

**Slotted Electrician's screwdriver
ISO 2380**

- blade chromium plated and Chrom-Vanadium
- with black tip
- with 2-component handle



Bestell-Nr. Order-no.	Abmessung mm Size mm	Klingenlänge mm Blade length mm	Gesamtlänge mm Total length mm
22-103006-0	2,5	75	160
22-103007-0	3,0	80	165
22-103010-0	3,5	100	200
22-103011-0	4,0	100	200
22-103012-0	4,5	125	230
22-103013-0	5,5	125	230
22-103015-0	5,0	150	270
22-103030-0	4,5	300	420



TAMPER TORX®-Schraubendreher

- mit verchromter Klinge Chrom-Vanadium
- schwarze Spitze
- mit 2-Komponenten-Griff

TAMPER TORX® screwdriver

- blade chromium plated and Chrom-Vanadium
- with black tip
- with 2-component handle



Bestell-Nr. Order-no.	Abmessung TX Size TX	Klingenlänge mm Blade length mm	Gesamtlänge mm Total length mm
22-104009-0	9	60	160
22-104010-0	10	80	180
22-104015-0	15	80	185
22-104020-0	20	100	200
22-104025-0	25	100	200
22-104027-0	27	115	230
22-104030-0	30	115	230
22-104040-0	40	130	250
22-104045-0	45	130	250

TORX®-Schraubendreher

- mit verchromter Klinge Chrom-Vanadium
- schwarze Spitze
- mit 2-Komponenten-Griff

TORX® screwdriver

- with black tip
- blade chromium plated and Chrom-Vanadium
- with 2-component handle



Bestell-Nr. Order-no.	Abmessung TX Size TX	Klingenlänge mm Blade length mm	Gesamtlänge mm Total length mm
22-105006-0	6	60	145
22-105007-0	7	60	145
22-105008-0	8	60	145
22-105009-0	9	60	145
22-105010-0	10	80	180
22-105015-0	15	80	185
22-105020-0	20	100	200
22-105025-0	25	100	200
22-105027-0	27	115	235
22-105030-0	30	115	235
22-105040-0	40	130	250
22-105045-0	45	130	250



TW-Schraubendreher

- mit verchromter Klinge Chrom-Vanadium
- schwarze Spitze
- mit 2-Komponenten-Griff

TW screwdriver

- blade chromium plated and Chrom-Vanadium
- with black tip
- with 2-component handle



Bestell-Nr. Order-no.	Abmessung TW Size TW	Klingenlänge mm Blade length mm	Gesamtlänge mm Total length mm
22-106002-0	2	80	165
22-106003-0	3	80	175
22-106004-0	4	80	185
22-106005-0	5	80	195

**Schlitz-Werkstatt-Schraubendreher
ISO 2380**

- Klinge vernickelt
- mit blauem Polypropylen Heft

**Slotted Workshop screwdriver
ISO 2380**

- blade nickel plated
- with blue plastic handle



Bestell-Nr. Order-no.	Klingenbreite mm blade width mm	Klingenlänge mm Blade length mm	Gesamtlänge mm Total length mm
22-107005-0	3,0	75	155
22-107007-0	4,0	100	185
22-107010-0	5,0	100	200
22-107012-0	5,5	125	240
22-107015-0	6,5	150	270
22-107017-0	8,0	175	300
22-107020-0	10,0	200	320
22-107025-0	12,0	250	370

**Kreuzschlitz-Schraubendreher
ISO 8764**

- Klinge vernickelt
- mit blauem Polypropylen Heft

**Screwdriver for PHILLIPS screws
ISO 8764**

- blade nickel plated
- with blue plastic handle



Bestell-Nr. Order-no.	Abmessung PH Size PH	Klingenlänge mm Blade length mm	Gesamtlänge mm Total length mm
22-108000-0	0	60	145
22-108001-0	1	80	180
22-108002-0	2	100	220
22-108003-0	3	150	270
22-108004-0	4	200	320

**PHZ-BIT-Schraubendreher
Two in One**

- mit rutschfestem Drehgriff
- Chrom-Vanadium

PHZ-BIT screwdriver Two in One

- with anti-slip handle
- Chrom-Vanadium



Bestell-Nr. Order-no.	Abmessung PHZ Size PHZ	Klingenlänge mm Blade length mm	Gesamtlänge mm Total length mm
22-111001-0	1	80	185
22-111002-0	2	100	210
22-111003-0	3	150	270

**PHZ-BIT-Schraubendreher 1.000 Volt
Two in One**

- mit rutschfestem Drehgriff
- mit isolierter Klinge
- VDE 1.000 V

**PHZ-BIT screwdriver 1.000 Volt
Two in One**

- with anti-slip handle
- blade insulated
- VDE 1.000 V



Bestell-Nr. Order-no.	Abmessung PHZ Size PHZ	Klingenlänge mm Blade length mm	Gesamtlänge mm Total length mm
22-112001-0	1	80	185
22-112002-0	2	100	210
22-112003-0	3	150	270

PH-Schraubendreher 1.000 Volt

- IEC 900
- mit 2-Komponenten-Griff
- Klinge isoliert

PH-screwdriver 1.000 Volt

- IEC 900
- with 2-component handle
- blade insulated



Bestell-Nr. Order-no.	Abmessung PH Size PH	Klingenlänge mm Blade length mm	Gesamtlänge mm Total length mm
22-117000-0	0	60	145
22-117001-0	1	80	180
22-117002-0	2	100	220
22-117003-0	3	150	270

Schlitz-Schraubendreher 1.000 Volt

- IEC 900
- mit 2-Komponenten-Griff
- Klinge isoliert

Screwdriver 1.000 Volt

- IEC 900
- with 2-component handle
- blade insulated



Bestell-Nr. Order-no.	Klingenlänge mm Blade length mm	Klingenbreite mm blade width mm	Gesamtlänge mm Total length mm
22-118002-0	75	2,5	155
22-118003-0	100	3,0	180
22-118004-0	100	3,5	190
22-118005-0	100	4,0	200
22-118006-0	125	5,5	235
22-118007-0	150	6,5	260
22-118008-0	175	8,0	285
22-118009-0	200	10,0	310



Schraubendreher ähnlich Typ ROBERTSON

- für Innen-4-kant Schrauben
- mit Plastik-Kraftgriff-Heft
- mit schwarzer Spitze

Screwdriver similar type ROBERTSON

- for internal 4-square screws
- with plastic handle
- with black tip



Bestell-Nr. Order-no.	Robertson Gr. Robertson size	Klingenlänge mm Blade length mm	Gesamtlänge mm Total length mm
22-120501-0	1	100	190
22-120502-0	2	125	225
22-120503-0	3	150	260

Umsteckschraubendreher

- mit vernickelter Klinge
- mit Plastikheft

Reversible screwdriver

- blade nickel plated
- plastic handle



Bestell-Nr. Order-no.	Abmessungen mm Size mm	Gesamtlänge mm Total length mm
22-125000-0	PH 2 + 6 mm	160

Vergaserschraubendreher PZ

- mit Plastikheft
- Klinge verchromt
- schwarze Spitze

Carburettor screwdriver PZ

- chromium plated
- plastic handle
- black tip



Bestell-Nr. Order-no.	Abmessung PZ Size PZ	Klingenlänge mm Blade length mm
22-126501-0	1	25
22-126502-0	2	25
22-126503-0	3	25

Vergaserschraubendreher

- mit Plastikheft
- Klinge verchromt
- schwarze Spitze

Carburettor screwdriver

- chromium plated
- plastic handle
- black tip



Bestell-Nr. Order-no.	Klingenbreite mm blade width mm	Klingenlänge mm Blade length mm
22-126045-0	4,5	25
22-126055-0	5,5	25
22-126060-0	6,0	25
22-126065-0	6,5	25
22-126080-0	8,0	25

Vergaserschraubendreher PH

- mit Plastikheft
- Klinge verchromt
- schwarze Spitze

Carburettor screwdriver PH

- chromium plated
- plastic handle
- black tip



Bestell-Nr. Order-no.	Abmessung PH Size PH	Klingenlänge mm Blade length mm
22-127001-0	1	25
22-127002-0	2	25
22-127003-0	3	25

Schraubendrehersatz

- 7-teilig, mit blauem Kunststoffheft
- Klengen vernickelt
- in Verkaufsbox

Screwdriver set

- set of 7 pieces
- blue handle
- in selling box

Bestell-Nr. Order-no.	Satz bestehend aus Set consists of
22-131000-0	75 x 4 mm
	100 x 4 mm
	100 x 5 mm
	125 x 5 mm
	150 x 5 mm
	PH 1
	PH 2

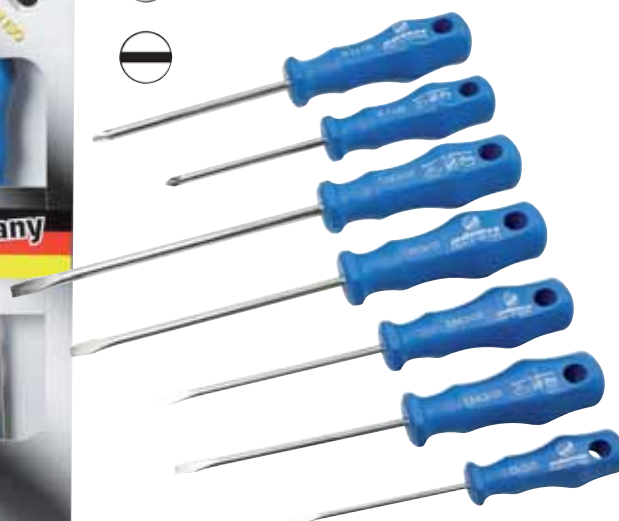

Schraubendrehersatz PROFI

- 12-teilig
- mit durchgehender Klinge und Außensechskant
- mit rutschfesten Griffen
- im Koffer

**screwdriver set PROFI**

- set of 12 pieces
- with hexagonal end
- blade going through non slipping handle
- in case

Bestell-Nr.
Order-no.

Satz bestehend aus
Set consists of

22-135000-9

3,2 x 72 mm
5,0 x 75 mm
6,0 x 100 mm
6,0 x 38 mm
8,0 x 150 mm
9,5 x 200 mm
PH 0 x 75 mm
PH 1 x 75 mm
PH 2 x 38 mm
PH 2 x 100 mm
PH 3 x 150 mm
PH 4 x 200 mm

**Schraubendrehersatz**

- 6-teilig mit schwarzem Kunststoffheft
- mit Schlüsselhilfe (6-kant am Griff)
- Chrom-Vanadium
- schwarze Spitze
- in Verkaufsbox

Screwdriver set

- set of 6 pcs. with black PVC handle
- with bolster (hexagonal end on handle)
- chrom-vanadium
- black tip
- in selling box



Bestell-Nr.
Order-no.

Satz bestehend aus
Set consists of

22-134000-0

4,0 mm
4,5 mm
5,5 mm
7,0 mm
PH1
PH2



Elektriker-Schraubendrehersatz 1.000 Volt

- 7-teilig
- isolierte Klängen
- 2-Komponenten-Griff

Electrician's screwdriver set 1.000 Volt

- set of 7 pieces
- insulated handle
- with soft grip handle

Bestell-Nr. Satz bestehend aus
Order-no. Set consists of

75 x 2,5 mm
100 x 4,0 mm
125 x 5,5 mm
150 x 6,5 mm
PH1
PH2
Tester

22-137000-9



Elektriker-Schraubendrehersatz 1.000 Volt

- 7-teilig
- isolierte Klinge
- rotes Kraftheft

Electrician's screwdriver set 1.000 Volt

- set of 7 pieces
- insulated handle
- with craft-handle

Bestell-Nr. Satz bestehend aus
Order-no. Set consists of

75 x 2,5 mm
100 x 4,0 mm
125 x 5,5 mm
150 x 6,5 mm
PH1
PH2
Tester

22-137100-0



Radio-Schraubendreher PRIMA

- je Abmessung 4 Stück auf Karte
- Satz zu 12 Stück

Radio screwdrivers PRIMA

- 4 pieces of each size on card
- set of 12 pieces

Bestell-Nr. Klingenlänge mm
Order-no. Blade length mm

22-138000-0 40 - 60 - 80

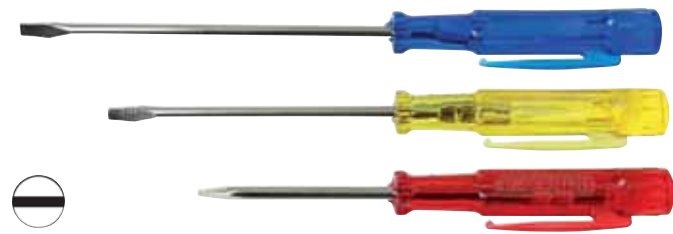

Radio-Schraubendreher mit Klipp**Radio screwdriver with clip**

Bestell-Nr. Order-no.	Klingenlänge x Klingenbreite mm Blade length x width mm	Gesamtlänge mm Total length mm
22-139040-0	40 x 3	100
22-139060-0	60 x 3	120
22-139080-0	80 x 3	140

Radio-Schraubendreher

- je Abmessung 20 Stück im Verkaufsständer
- Set mit 60 Stück

Radio screwdriver

- 20 pieces of each size in stand
- set of 60 pieces



Bestell-Nr. Order-no.	Klingenlänge mm Blade length mm
22-141000-0	0 - 60 - 80

Miniatur Schraubendreher

- 60 Stück im Verkaufsständer

Miniature screwdriver

- set of 60 pieces on stand



Bestell-Nr. Order-no.	Klingenlänge x Klingenbreite mm Blade length x width mm	Gesamtlänge mm Total length mm	Ausführung Execution
22-142000-0	40 x 2	80	Ständer/stand
22-143000-0	40 x 2	80	lose/loose

Kreuzschlitz Schraubendreher

- 60 Stück im Verkaufsständer

Screwdriver for PHILLIPS screws

- set of 60 pieces on stand



Bestell-Nr. Order-no.	Abmessung mm Size mm	Gesamtlänge mm Total length mm
22-144000-0	PH 0 x 40	100

Spannungstester TESTBOY 40 PLUS

- zweipolig, 6-400 Volt AC/DC
- Phasensuche gegen den Schutzleiter
- für Gleich- und Wechselspannungen

Power tester TESTBOY 40 PLUS

- 2-pole
- 6-400 V. AC/DC
- for direct & alternating current



Bestell-Nr. Order-no.	Abmessung mm Size mm
22-146000-0	120 x 60 x 30

Spannungstester TESTBOY 10

- DIN VDE 0411
- zum Erkennen von Wechselspannungen ohne Stromfluss
- Kabelbrüchen und defekten Sicherungen
- Schaltern
- Steckdosen
- Lichterketten etc.

Power tester TESTBOY 10

- DIN VDE 0411
- useable for all electrician wire
- checking of all defect plugs
- cable etc.



Bestell-Nr. Order-no.	Länge mm Length mm
22-146010-9	142

Spannungsprüfer VDE/CE geprüft

- 150-250 Volt
- klar
- mit Messingkappe

Voltage tester VDE/CE approval

- 150-250 Volt
- clear
- with brass cap



Bestell-Nr. Order-no.	Klingenlänge mm Blade length mm	Gesamtlänge mm Total length mm
22-151010-0	100	190

Spannungsprüfer VDE/CE geprüft

- 150-250 Volt
- klar
- mit Kunststoffkappe

Voltage tester VDE/CE approval

- 150-250 Volt
- clear
- with plastic cap



Bestell-Nr. Order-no.	Klinge mm Blade mm	Gesamtlänge mm Total length mm	Klipp Clip
22-150010-0	100	190	ohne/without
22-150060-0	60	140	mit/with

EURO-Spannungsprüfer

- VDE/GS/CE geprüft
- 125-250 Volt
- rund
- mit Klipp

EURO-Voltage tester

- VDE/GS/CE approval
- 125-250 Volt
- round
- with clip



Bestell-Nr. Order-no.	Gesamtlänge mm Total length mm
22-152015-0	150
22-152019-0	190



EURO-Prüfer VDE-GS-CE geprüft

- 150-250 Volt
- mit Klipp

EURO-Voltage tester VDE-GS approval

- 125-250 Volt
- with clip



Bestell-Nr. Order-no.	Gesamtlänge mm Total length mm
22-153015-0	150
22-153019-0	190

Spannungsprüfer mit Kunststoffkappe

- 100-500 Volt
- gelb
- sind nicht geprüft nach VDE 0680

Voltage tester with plastic cap

- 100-500 Volt
- yellow
- without approval according to VDE 0680



Bestell-Nr. Order-no.	Klinge mm Blade mm	Gesamtlänge mm Total length mm	Klipp Clip
22-154510-0	100	190	ohne/without
22-154560-0	60	140	mit/with

Spannungsprüfer mit Kunststoffkappe

- 100-500 Volt
- glasklar
- sind nicht geprüft nach VDE 0680

Voltage tester with plastic cap

- 100-500 Volt
- clear
- without approval according to VDE 0680



Bestell-Nr. Order-no.	Klinge mm Blade mm	Gesamtlänge mm Total length mm	Klipp Clip
22-154010-0	100	190	ohne/without
22-154060-0	60	140	mit/with

Spannungsprüfer mit Messingkappe

- 100-500 Volt
- glasklar
- sind nicht geprüft nach VDE 0680

Voltage tester with brass cap

- 100-500 Volt
- clear
- without approval according to VDE 0680



Bestell-Nr. Order-no.	Klinge mm Blade mm	Gesamtlänge mm Total length mm	Klipp Clip
22-155010-0	100	190	ohne/without
22-155060-0	60	140	mit/with

Spannungsprüfer mit Messingkappe

- 100-500 Volt
- gelb
- sind nicht geprüft nach VDE 06880

Voltage tester with brass cap

- 100-500 Volt
- yellow
- without approval according to VDE 0680

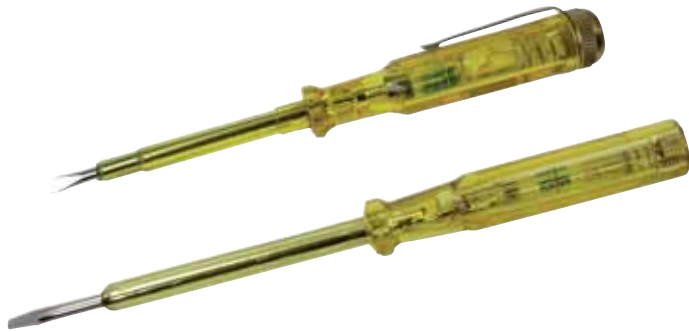

Bestell-Nr. Order-no.	Klinge mm Blade mm	Gesamtlänge mm Total length mm	Klipp Clip
22-155510-0	100	190	ohne/without
22-155560-0	60	140	mit/with

Auto-Stromprüfer

- 6-24 Volt
- mit Klemme und 1 Meter Kabel

Car light tester

- 6-24 Volt
- with clamp and 1 meter cable



Bestell-Nr. Order-no.	Abmessung mm Size mm	Tasche Wallet
22-162000-0	120	mit/with
22-162001-0	120	ohne/without

Auto-Stromprüfsatz

- 6-24 Volt
- Zündkerzen- und Stromprüfer
- 2-teilig
- mit Klemme und Kabel
- in Tasche

Car light and spark plug tester set

- 6-24 Volt
- set of 2 pieces
- with clamp
- in wallet



Bestell-Nr. Order-no.	Abmessung mm Size mm
22-160000-0	120

Auto-Stromprüfer aus Messing

- 6-24 Volt
- mit Klemme und ein Meter Kabel
- in Einzeltasche

Car light tester all brass

- 6-24 Volt
- with clamp and one meter cable
- in wallet



Bestell-Nr. Order-no.	Abmessung mm Size mm
22-163000-0	120

Winkelschraubendreher

- vernickelt
- Chrom-Vanadium

Offset screwdriver

- nickel plated
- Chrom-Vanadium



Bestell-Nr. Order-no.	Klingenbreite mm blade width mm	Gesamtlänge mm Total length mm
22-177010-0	4,0	100
22-177012-0	5,5	125
22-177015-0	8,0	150

LCD Digital-Multimeter

- mit Aufsteller
- Gleichspannung 200 mV, 2, 20, 200, 600 V
- Wechselspannung 200 Volt, 600 Volt
- Gleichstrom 0,2 mA, 2 mA, 20 mA, 200 mA, 10 A
- Diodentest
- Speichertaste

Digital LCD Multimeter

- with put-up hinge
- testing probes are available separately
- DC voltage 200 mV
- 2, 20, 200, 600 V
- AC voltage 200 V, 600 V
- DC current 0,2 mA, 2 mA, 20 mA, 200 mA, 10 A
- diode tester
- data hold



Bestell-Nr.
Order-no.
[22-190000-9](#)

PHILLIPS Winkelschraubendreher

- vernickelt
- Chrom-Vanadium

PHILLIPS offset screwdriver

- nickel plated
- Chrom-Vanadium



Bestell-Nr. Order-no.	Klinge PH blade PH	Gesamtlänge mm Total length mm
22-178010-0	1 + 2	100

LCD Digital-Multimeter

- Wechselspannung (AC V) bis 750 Volt
- Bereiche 200 Volt und 750 Volt,
- Gleichspannung (DC Volt) bis 1.000 V, Bereiche 200 mV, 2.000 mV, 20 V, 200 V, 1.000 V
- Gleichstrom (DC A) 0,2 mA, 2 mA, 20 mA, 200 mA, 10 A
- Widerstand 200 Ohm, 2.000 Ohm, 20 kOhm, 200 kOhm, 2.000 kOhm
- Durchgangstest mit Signalton

Digital LCD Multimeter

- voltage (AC) up to 750 Volt
- 200 Volt and 750 Volt ranges
- voltage /DC) up to 1.000 V, ranges 200 mV, 2.000 mV, 20 V, 200 V, 1.000 V
- direct current (DC)
- 0,2 mA, 2 mA, 20 mA, 200 mA, 10 A
- resistance
- 200 Ohm, 2.000 Ohm, 20 kOhm, 200 kOhm, 2.000 kOhm
- continuity test with buzzer



Bestell-Nr.
Order-no.
[22-191000-9](#)

Nylon-Kabelbinder

- transparent
- witterungsbeständig von -40° bis +85° (110°)

Cable ties made of nylon

- transparent
- weather resistant from -40° to +85° (110°)



Bestell-Nr. Order-no.	Länge x Breite mm Length x width mm	Stück/Paket Pieces/ package
22-193000-0	98 x 2,5	100
22-193014-0	135 x 2,5	100
22-193016-0	160 x 2,6	100
22-193001-0	200 x 2,6	100
22-193015-0	140 x 3,5	100
22-193002-0	200 x 3,5	100
22-193003-0	290 x 3,5	100
22-193025-0	370 x 3,5	100
22-193017-0	178 x 4,8	100
22-193004-0	200 x 4,8	100
22-193005-0	250 x 4,8	100
22-193006-0	290 x 4,8	100
22-193007-0	360 x 4,8	100
22-193008-0	390 x 4,8	100
22-193009-0	430 x 4,8	100
22-193018-0	240 x 7,8	100
22-193010-0	300 x 7,8	100
22-193011-0	365 x 7,8	100
22-193012-0	450 x 7,8	100
22-193013-0	540 x 7,8	100
22-193021-0	750 x 7,8	100
22-193022-0	780 x 9,0	100
22-193019-0	500 x 12,5	50
22-193020-0	720 x 12,5	50
22-193023-0	850 x 12,5	50
22-193024-0	1.000 x 12,5	50

Nylon-Kabelbinder

- schwarz
- witterungsbeständig von -40° bis +85° (110°)

Cable ties made of nylon

- black
- weather resistant from -40° to +85° (110°)



Bestell-Nr. Order-no.	Länge x Breite mm Length x width mm	Stück/Paket Pieces/package
22-194000-0	98 x 2,5	100
22-194014-0	135 x 2,5	100
22-194016-0	160 x 2,6	100
22-194001-0	200 x 2,6	100
22-194015-0	140 x 3,5	100
22-194002-0	200 x 3,5	100
22-194003-0	290 x 3,5	100
22-194025-0	370 x 3,5	100
22-194017-0	178 x 4,8	100
22-194004-0	200 x 4,8	100
22-194005-0	250 x 4,8	100
22-194006-0	290 x 4,8	100
22-194007-0	360 x 4,8	100
22-194008-0	390 x 4,8	100
22-194009-0	430 x 4,8	100
22-194018-0	240 x 7,8	100
22-194010-0	300 x 7,8	100
22-194011-0	365 x 7,8	100
22-194012-0	450 x 7,8	100
22-194013-0	540 x 7,8	100
22-194021-0	750 x 7,8	100
22-194022-0	780 x 9,0	100
22-194019-0	500 x 12,5	50
22-194020-0	720 x 12,5	50
22-194023-0	850 x 12,5	50
22-194024-0	1.000 x 12,5	50

FLEX-Einziehspirale

- mit Kugel und Zugöse
- Ø 4 mm
- 4-fach gedreht

FLEX Spiral steel band

- with eyelet and ball
- Ø 4 mm
- four-fold steel



Bestell-Nr. Order-no.	Länge m Length m
22-196005-0	5
22-196010-0	10
22-196015-0	15
22-196020-0	20
22-196025-0	25
22-196030-0	30

Nylon-Einziehband

- mit Suchfeder und Öse
- Ø 3 mm
- transparent

Plastic draw-in band

- with finder spring and eyelet
- Ø 3 mm
- transparent

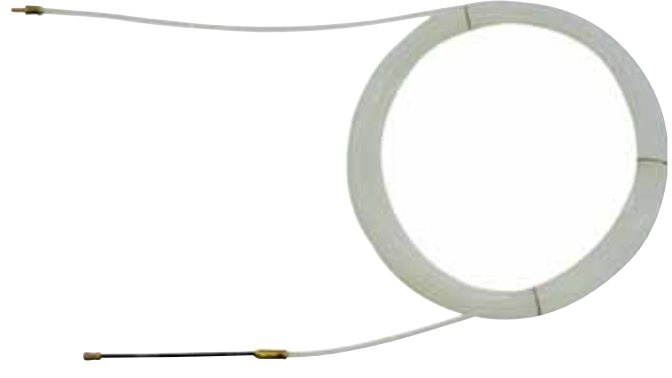

Bestell-Nr. Order-no.	Länge m Length m
22-198005-0	5
22-198010-0	10
22-198015-0	15
22-198020-0	20
22-198025-0	25
22-198030-0	30

Stahleinziehband

- Flachstahl 3,5 x 0,5 mm
- mit zwei Ösen
- zum Einziehen der Drähte in Isolierrohre

Electrician's flat steel band

- flat steel 3,5 x 0,5 mm
- with two eyelets
- for feeding wire in insulating pipes



Bestell-Nr. Order-no.	Länge m Length m
22-197005-0	5
22-197010-0	10
22-197015-0	15
22-197020-0	20
22-197025-0	25
22-197030-0	30

Nylon-Einziehband

- mit Suchfeder und Öse
- Ø 3 mm
- schwarz

Plastic draw-in band

- with finder spring and eyelet
- Ø 3 mm
- black finish



Bestell-Nr. Order-no.	Länge m Length m
22-199005-0	5
22-199010-0	10
22-199015-0	15
22-199020-0	20
22-199025-0	25
22-199030-0	30

Nylon-Einziehband

- mit Suchfeder und Öse
- Ø 4 mm
- schwarz

Plastic draw-in band

- with finder spring and eyelet
- Ø 4 mm
- black finish



Bestell-Nr. Order-no.	Länge m Length m
22-199105-0	5
22-199110-0	10
22-199115-0	15
22-199120-0	20
22-199125-0	25
22-199130-0	30

Nylon-Einziehband

- mit 2 Ösen
- Ø 3 mm
- transparent

Plastic draw-in band

- with 2 eyelets
- Ø 3 mm
- transparent

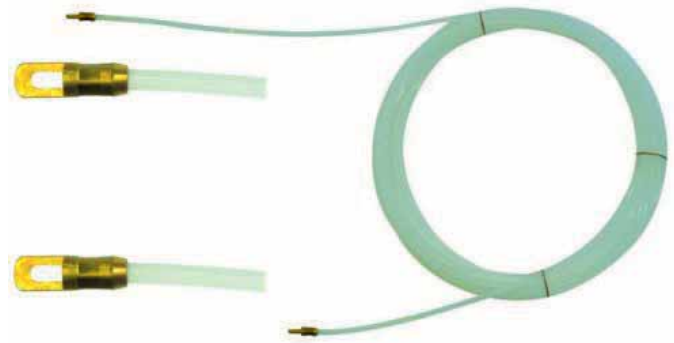

Bestell-Nr. Order-no.	Länge m Length m
22-201005-0	5
22-201010-0	10
22-201015-0	15
22-201020-0	20
22-201025-0	25
22-201030-0	30

Nylon-Einziehband

- mit Kugel und Öse
- Ø 3 mm
- transparent

Plastic draw-in band

- 1 eyelet, 1 pressed end
- Ø 3 mm
- transparent

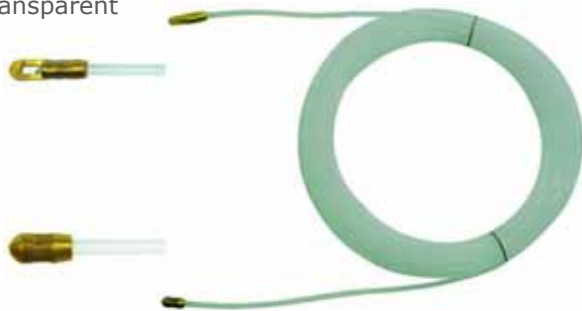

Bestell-Nr. Order-no.	Länge m Length m
22-200005-0	5
22-200010-0	10
22-200015-0	15
22-200020-0	20
22-200025-0	25
22-200030-0	30

Stahleinziehband

- Flachstahl 3,5 x 0,5 mm
- mit Öse und Suchfeder
- zum Einziehen der Drähte in Isolierrohre

Electrician's flat steel band

- 3,5 x 0,5 mm
- with eyelet and finder spring



Bestell-Nr. Order-no.	Länge m Length m
22-202005-0	5
22-202010-0	10
22-202015-0	15
22-202020-0	20
22-202025-0	25
22-202030-0	30

Kabelmesser JOKARI®

- zum Abmanteln aller gängigen Rundkabel
- mit Einstellschraube

Cable stripper JOKARI®

- for stripping all standard round cables
- with adjustment screw



Bestell-Nr.
Order-no.

22-210016-0

22-211028-0

Abisolierwerte Ø mm
Working area Ø mm

4-16

8-28

Kabelmesser JOKARI®

automatische Einstellung auf Rund- und Längsschnitt

Cable stripper JOKARI®

automatic adjustment for round or lengthwise cutting



Bestell-Nr.
Order-no.

22-211050-0

Abisolierwerte Ø mm
Working area Ø mm

35-50

Kabelmesser JOKARI®

- zum Abmanteln aller gängigen Rundkabel
- mit Einstellschraube

Cable stripper JOKARI®

- for stripping all standard round cables
- with adjustment screw



Bestell-Nr.
Order-no.

22-211035-0

Abisolierwerte Ø mm
Working area Ø mm

27-37

Kabelmesser JOKARI®

- mit gerader Klinge
- Schnitttiefe einstellbar
- automatische Einstellung auf Rund- und Längsschnitt

Cable stripper JOKARI®

- straight blade
- cutting depth adjustable
- automatic adjustment for round or lengthwise cutting



Bestell-Nr.
Order-no.

22-212000-0

Abisolierwerte Ø mm
Working area Ø mm

8-28

Abisoliermesser JOKARI®

- mit Hakenklinge
- automatische Einstellung auf Rund- und Längsschnitt

Cable stripper JOKARI®

- hook blade
- cutting depth adjustable
- automatic adjustment for round or lengthwise cutting



Bestell-Nr.
Order-no.

22-213000-0

Abisolierwerte Ø mm
Working area Ø mm

8-28

Entmanteler JOKARI® SECURA SUPER

- mit innenliegendem Messer
- zum Abmanteln von Kabeln mit 8-13 mm Ø und Abisolieren von Leitern 0,2-4 mm²
- keine Justierung erforderlich
- mit Längsschnitt und Abisoliervorrichtung
L=125 mm/Ø=25 mm

Cable stripper JOKARI® SECURA SUPER

- knife inside, retractable
- for stripping cable Ø 8-13 mm and conductor cable 0,2-4 mm²
- no cutting depth adjustment necessary
- circular and longitudinal section
L = 25 mm/Ø=25 mm



Bestell-Nr.
Order-no.

22-215000-0

Ersatzklingen Kabelmesser JOKARI®**Spare cable stripping blade JOKARI®**

Bestell-Nr.
Order-no.

22-214000-0

passend für
suitable for

22-210016
22-211028
22-212000
22-213000

Allrounder JOKARI®

- Abisolierer für Rund- und Flachkabel und Leiter
- rund- und längsschneidend
- COAX-Kabel von Ø 4-8 mm
- NYM-Kabel Ø 4-15 mm
- Leiter 1,5-2,5 mm²

Cable stripper JOKARI®

- round/flat cable and conductor stripping
- round and lengthwise cutting
- COAX cable Ø 4-8 mm
- NYM-cable Ø 4-15 mm
- conductor stripping of 1,5-2,5 mm²



Bestell-Nr.
Order-no.

22-216000-0

Entmantler JOKARI® SECURA

- geeignet für alle gängigen Rundkabel
- automatische Einstellung auf Rund- und Längsschnitt

Cable stripper JOKARI® SECURA

- for stripping all standard round cable
- with adjustment screw



Bestell-Nr.
Order-no.

22-217000-0

Abisolierwerte Ø mm
Working area Ø mm

8-28

Abisolierer JOKARI® PWS PLUS 002

- für Anwendungen in der Elektronik, Telekommunikation und Modellbau
- Abisolierbereich einstellbar

Strip JOKARI® PWS PLUS 002

- suitable for electronic, telecommunication and modelling purpose
- stripping range adjustable



Bestell-Nr.
Order-no.

22-218002-0

Abisolierwerte Ø mm
Working area Ø mm

0,25-0,8

Entmantler JOKARI® STRIP

- zum Entmanteln von Rundkabeln Ø 4-13 mm
- Flachkabel bis 12 mm Breite
- Leiter/Litze 0,8-1,5-2,5 mm²

Cable stripper JOKARI® STRIP

- stripping of round cable Ø 4-13 mm
- stripping of flat cable up to 12 mm width
- conductor stripping 0,8-1,5-2,5 mm²



Bestell-Nr.
Order-no.

22-218000-0

PC-Strip JOKARI®

- zum Entmanteln von Rundkabeln
- Abisolieren von verschiedenen Kabeltypen, z. B. IBM
- flexible Leitungen etc.

PC-Strip JOKARI®

- stripping of round cable
- stripping of various cable types
- no cutting depth adjustment required



Bestell-Nr.
Order-no.

22-218015-0

Abisolierwerte Ø mm
Working area Ø mm

5-15

TOP COAX JOKARI®

zum Abmanteln von allen gängigen Coaxkabel

- Antennenkabel Ø 4,8-7,5 mm
- Rundkabel 3 x 0,75 mm²

TOP COAX JOKARI®

for quick and easy stripping of most common coaxial cable types

- TV-antenna cable types Ø 4,8-7,5 mm
- round PVC cable 3 x 0,75 mm²



Bestell-Nr.
Order-no.

22-218075-0

Kabelmesser mit Holzschale

Klinge mit integriertem Schaber

Electrician's pocket knife

blade with integral scraper



Bestell-Nr.
Order-no.

22-220000-0

Ausführung
Execution

1-teilig/parts

Abisolierzange JOKARI® SUPER 4 PLUS

- keine Einstellung notwendig
- Längenanschlag von 6,0-15,0 mm
- für Leiter & Litzen 0,2-6,0 mm²

SUPER 4 PLUS JOKARI®

- no diameter adjustment required
- length stopper adjustment from 6-18 mm
- ergonomic antenatic wire stripper for wire 0,2-6,0 mm²



Bestell-Nr.
Order-no.

22-219000-0

Kabelmesser mit Holzschale

mit Klinge und Schaber

Electrician's pocket knife

with blade and
separate scraper



Bestell-Nr.
Order-no.

22-221000-0

Ausführung
Execution

2-teilig/parts

Kabelmesser mit Holzschale

- Klinge
- Schaber
- Schraubendreher

Electrician's pocket knife

- with blade
- scraper
- screwdriver



Bestell-Nr.
Order-no.

22-223000-0

Ausführung
Execution

3-teilig/parts

Kabeltrennmesser

mit isoliertem Griff

Hacking knife

with insulated plastic handle



Bestell-Nr.
Order-no.

22-224500-9

Klingenlänge mm
Blade length mm

100

Gesamtlänge mm
Total length mm

210

Kabelmesser mit Holzschale

- Klinge
- Säge
- Schraubendreher
- Schaber

Electrician's pocket knife

- with blade
- saw
- screwdriver
- scraper



Bestell-Nr.
Order-no.

22-224000-0

Ausführung
Execution

4-teilig/parts

Elektrikermesser

Klinge rostfrei

Electrician's knife

blade made of INOX-steel



Bestell-Nr.
Order-no.

22-226000-9

Klingenlänge mm
Blade length mm

80

Gesamtlänge mm
Total length mm

190

Kabelmesser mit Holzgriff

- feststehend
- mit Schaber
- gerade

Electrician's cable knife

- with integral scraper
- straight
- wooden handle



Bestell-Nr.
Order-no.

[22-228000-0](#)

Länge mm
Length mm

185

Abisolierer KABIFIX

- für isolierte Leitungen
- Abschneiden von Kunststoffrohren
- Messer gehärtet
- leicht auswechselbar

Cable stripper KABIFIX

- for cutting insulated cable
- for cutting PVC tubes
- knife hardened
- easy exchangeable



Bestell-Nr.
Order-no.

[22-230000-0](#)

Artikel
Item

Abisolierer

Arbeitsbereich Ø mm
Working area Ø mm

6-28

[22-231000-0](#)

Ersatzmesser/spare knife

Kabelmesser mit Holzgriff

- feststehend
- gerade Form

Electrician's cable knife

- straight
- wooden handle



Bestell-Nr.
Order-no.

[22-229000-0](#)

Länge mm
Length mm

185

Pinzette gerade

- vernickelt
- innen leicht geriffelt

Tweezer straight

- nickel plated
- inside slightly knurled



Bestell-Nr.
Order-no.

[22-233012-0](#)

[22-233013-0](#)

[22-233014-0](#)

[22-233016-0](#)

Länge mm
Length mm

120

130

145

160

Pinzette gebogen

- vernickelt
- innen leicht geriffelt

Tweezer bent

- nickel plated
- inside slightly knurled



Bestell-Nr. Order-no.	Länge mm Length mm
22-234012-0	120
22-234013-0	130
22-234014-0	145
22-234016-0	160

Feinmechaniker-Schraubendreher PH

mit kanneliertem vernickeltem Stahlgriff

Watchmaker's screwdriver PH

- nickel plated
- handle made of metal



Bestell-Nr. Order-no.	Größe PH Size PH	Klinge Ø mm Blade Ø mm	Gesamtlänge mm Total length mm
22-241015-0	0000	1,5	90
22-241020-0	000	2,0	100
22-241025-0	00	2,5	108
22-241030-0	0	3,0	118

Feinmechaniker-Schraubendreher

mit kanneliertem vernickeltem Stahlgriff

Watchmaker's screwdriver

- nickel plated
- handle made of metal



Bestell-Nr. Order-no.	Klinge mm Blade mm	Gesamtlänge mm Total length mm
22-240008-0	0,8	84
22-240010-0	1,0	84
22-240015-0	1,5	86
22-240018-0	1,8	102
22-240020-0	2,0	102
22-240023-0	2,3	104
22-240025-0	2,5	104

Feinmechaniker-Schraubendreher

mit 5 auswechselbaren Klingen

Watchmaker's screwdriver

with 5 changeable blades



Bestell-Nr. Order-no.	Klingen mm Blades mm	Gesamtlänge mm Total length mm
22-242000-0	1,0	120
	1,5	
	2,0	
	2,5	
	3,0	

Feinmechaniker-Schraubendreher

- 6-teilig
- in Plastiktasche
- vernickelter Stahlgriff

Watchmaker' s screwdrivers set

- set of 6 pieces
- in wallet
- nickel plated metal handle



Bestell-Nr.
Order-no.

Klingen
Blades
1,5 mm
2,0 mm
2,5 mm
2,9 mm
PH 0
PH 1

22-243000-0

Drill-Bindewerkzeug

mit schwarzem Gummigriff

Wire bending drill

with black rubber handle



Bestell-Nr.
Order-no.

22-253031-0

Länge mm
Length mm

310

Magnet-Hebewerkzeug

- sehr flexibel
- mit Plastikheft

Magnetic pick-up tool

- flexible
- with plastic handle



Bestell-Nr.
Order-no.

Hebt bis g
Cap. up to g

Magnet Ø mm
Magnet Ø mm

Länge mm
Length mm

22-250006-0

500

6

460

22-250009-0

1.000

9

460

22-250013-0

1.800

13

520

22-250017-0

3.000

17

530

Drill-Bindewerkzeug

mit rotem Kunststoffgriff oben an der Öse

Wire bending drill

with red handle on loop



Bestell-Nr.
Order-no.

22-254028-0

Länge mm
Length mm

280

Drill-Bindewerkzeug

mit rotem Kunststoffgriff unten am Haken

Wire bending drill

with red handle on hook



Bestell-Nr.
Order-no.

22-255028-0

Länge mm
Length mm

280

PH-Schraubendreher-TINBIT

- 6,35 (1/4") 6-kant
- Form C 6,3-DIN 3126

PH screwdriver TINBIT

- 6,35 (1/4") hexagonal
- Form C 6,3-DIN 3126



Bestell-Nr.
Order-no.

22-260001-0

Größe PH
Size PH

1

Länge mm
Length mm

25

22-260002-0

2

25

22-260003-0

3

25

Adaptersatz 3-teilig

für den Gebrauch in Akku-Schrauber oder elektrischer Bohrmaschine

Adapter set of 3 pieces

usable for electric drilling machine



Bestell-Nr.
Order-no.

22-257000-9

Für Antrieb Zoll
For drive inch

1/4

3/8

1/2

Länge mm
Length mm

75

PZ-Schraubendreher-TINBIT

- 6,35 (1/4") 6-kant
- Form C 6,3-DIN 3126

PZ screwdriver TINBIT

- 6,35 (1/4") hexagonal
- Form C 6,3-DIN 3126



Bestell-Nr.
Order-no.

22-261001-0

Größe PZ
Size PZ

1

Länge mm
Length mm

25

22-261002-0

2

25

22-261003-0

3

25

TORX®-Schraubendreher-TINBIT

- 6,35 (1/4") 6-kant
- Form C 6,3-DIN 3126

Screwdriver TORX® TINBIT

- 6,35 (1/4") hexagonal
- Form C 6,3-DIN 3126



Bestell-Nr. Order-no.	Größe TX Size TX	Länge mm Length mm
22-262010-0	10	25
22-262015-0	15	25
22-262020-0	20	25
22-262025-0	25	25
22-262027-0	27	25
22-262030-0	30	25
22-262040-0	40	25

Schlitz-Schraubendreher-TINBIT

- 6,35 (1/4") 6-kant
- Form C 6,3-DIN 3126

Slotted screwdriver TINBIT

- 6,35 (1/4") hexagonal
- Form C 6,3-DIN 3126



Bestell-Nr. Order-no.	Klingenstärke x Klingenbreite mm Blade thickness x width mm	Länge mm Length mm
22-263002-0	0,6 x 3,5	25
22-263003-0	0,8 x 4,0	25
22-263005-0	1,0 x 5,5	25
22-263006-0	1,2 x 6,5	25



PH-Schraubendreher-TINBIT

- 6,35 (1/4") 6-kant
- Form C 6,3-DIN 3126

Screwdriver PH TINBIT

- 6,35 (1/4") hexagonal
- Form C 6,3-DIN 3126



Bestell-Nr. Order-no.	Größe PH Size PH	Länge mm Length mm
22-264001-0	1	50
22-264002-0	2	50
22-264003-0	3	50

PZ-Schraubendreher-TINBIT

- 6,35 (1/4") 6-kant
- Form C 6,3-DIN 3126

PZ screwdriver TINBIT

- 6,35 (1/4") hexagonal
- Form C 6,3-DIN 3126



Bestell-Nr. Order-no.	Größe PZ Size PZ	Länge mm Length mm
22-265001-0	1	50
22-265002-0	2	50
22-265003-0	3	50

PH-Schraubendreher-BIT

- 6,35 (1/4") 6-kant
- Form C 6,3-DIN 3126

PH screwdriver BIT

- 6,35 (1/4") hexagonal
- Form C 6,3-DIN 3126



Bestell-Nr. Order-no.	Größe PH Size PH	Länge mm Length mm
22-268001-0	1	25
22-268002-0	2	25
22-268003-0	3	25

Two in One Schraubendreher-BIT

- SUPERIOR „System PHZ“
- Form C 6,35 (1/4") 6-kant
- DIN 3126

Two in One screwdriver BIT

- SUPERIOR „System PHZ“
- Form C 6,35 (1/4") hexagonal
- DIN 3126



Bestell-Nr. Order-no.	Größe PHZ Size PHZ	Länge mm Length mm
22-266001-0	1	25
22-266002-0	2	25
22-266003-0	3	25
22-267001-0	1	50
22-267002-0	2	50
22-267003-0	3	50

PZ-Schraubendreher-BIT

- 6,35 (1/4") 6-kant
- Form C 6,3-DIN 3126

PZ screwdriver BIT

- 6,35 (1/4") hexagonal
- Form C 6,3-DIN 3126



Bestell-Nr. Order-no.	Größe PZ Size PZ	Länge mm Length mm
22-269001-0	1	25
22-269002-0	2	25
22-269003-0	3	25

TORX®-Schraubendreher-BIT

- 6,35 (1/4") 6-kant
- Form C 6,3-DIN 3126

TORX® screwdriver BIT

- 6,35 (1/4") hexagonal
- Form C 6,3-DIN 3126



Bestell-Nr. Order-no.	Größe TX Size TX	Länge mm Length mm
22-270010-0	10	25
22-270015-0	15	25
22-270020-0	20	25
22-270025-0	25	25
22-270027-0	27	25
22-270030-0	30	25
22-270040-0	40	25

**Schraubendreher-BIT
ähnlich ROBERTSON**

- 6,35 (1/4") 6-kant
- Form C 6,3-DIN 3126
- für innen 4-kant Schrauben

Screwdriver BIT similar ROBERTSON

- 6,35 (1/4") hexagonal
- Form C 6,3-DIN 3126
- for internal screws



Bestell-Nr. Order-no.	Größe Size	Länge mm Length mm
22-271500-9	0	25
22-271501-9	1	25
22-271502-9	2	25
22-271503-9	3	25
22-271504-9	4	25

Schlitz-Schraubendreher-BIT

- 6,35 (1/4") 6-kant
- Form C 6,3-DIN 3126

Slotted screwdriver BIT

- 6,35 (1/4") hexagonal
- Form C 6,3-DIN 3126



Bestell-Nr. Order-no.	Größe mm Size mm	Länge mm Length mm
22-271000-0	0,5 x 3,0	25
22-271002-0	0,6 x 3,5	25
22-271003-0	0,8 x 4,0	25
22-271004-0	1,0 x 5,5	25
22-271005-0	1,2 x 6,5	25

PH-Schraubendreher-BIT

- 6,35 (1/4") 6-kant
- Form C 6,3-DIN 3126
- lange Ausführung

PH screwdriver BIT

- 6,35 (1/4") hexagonal
- Form C 6,3-DIN 3126
- long version



Bestell-Nr. Order-no.	Größe PH Size PH	Länge mm Length mm
22-272001-0	1	50
22-272002-0	2	50
22-272003-0	3	50

PZ-Schraubendreher-BIT

- 6,35 (1/4") 6-kant
- Form C 6,3-DIN 3126
- lange Ausführung

PZ screwdriver BIT

- 6,35 (1/4") hexagonal
- Form C 6,3-DIN 3126
- long version



Bestell-Nr. Order-no.	Größe PZ Size PZ	Länge mm Length mm
22-273001-0	1	50
22-273002-0	2	50
22-273003-0	3	50

PZ-Schraubendreher-BIT

- doppelseitig
- 6,35 (1/4") 6-kant
- Form C 6,3-DIN 3126

PZ screwdriver BIT

- double sided
- 6,35 (1/4") hexagonal
- Form C 6,3-DIN 3126



Bestell-Nr. Order-no.	Größe PZ Size PZ	Länge mm Length mm
22-274101-0	1 x 1	65
22-274102-0	2 x 2	65
22-274103-0	3 x 3	65

PH-Schraubendreher-BIT

- doppelseitig
- 6,35 (1/4") 6-kant
- Form C 6,3-DIN 3126

PH screwdriver BIT

- double sided
- 6,35 (1/4") hexagonal
- Form C 6,3-DIN 3126



Bestell-Nr. Order-no.	Größe PH Size PH	Länge mm Length mm
22-274001-0	1 x 1	65
22-274002-0	2 x 2	65
22-274003-0	3 x 3	65

Kugelkopf-Schraubendreher-BIT

- 6,35 (1/4") 6-kant
- Form C 6,3-DIN 3126

Ball head screwdriver BIT

- 6,35 (1/4") hexagonal
- Form C 6,3-DIN 3126



Bestell-Nr. Order-no.	Größe mm Size mm	Länge mm Length mm
22-274503-0	3,0	25
22-274504-0	4,0	25
22-274505-0	5,0	25
22-274506-0	6,0	25

BIT-Schraubendrehersatz PROFI

- 31-teilig in Bitbox mit Hosenklipp
- beste Profi-Qualität
- mit Magnetbithalter

BIT screwdriver set PROFI

- set of 31 pieces
- with magnetic bit holder
- in box



Bestell-Nr.
Order-no.

Inhalt
Content

TX 10 - 40
6-kant 3, 4, 5
PH/PZ 1, 2, 3
0,6 x 4,5 mm
1,0 x 5,5 mm
1,2 x 6,5 mm

22-277000-9

BIT-Schraubendrehersatz

- 7-teilig
- mit Magnetbithalter
- in Bitbox

BIT screwdriver set

- set of 7 pieces
- with magnetic bit holder
- in box



Bestell-Nr.
Order-no.

Inhalt
Content

PZ 1, 2, 3
0,5 x 4,0 mm
1,0 x 5,5 mm
1,2 x 6,5 mm

22-277015-9

BIT-Schraubendrehersatz

- 7-teilig
- mit Magnetbithalter
- in Bitbox

BIT screwdriver set

- set of 7 pieces
- with magnetic bit holder
- in box



Bestell-Nr.
Order-no.

Inhalt
Content

PH/PZ 1, 2
1.0 x 5.5
1.2 x 6.5 mm

22-277010-9

BIT-Schraubendrehersatz TORX®

- 7-teilig
- mit Magnetbithalter
- in Bitbox

BIT screwdriver set TORX®

- set of 7 pieces
- with magnetic bit holder
- in box



Bestell-Nr.
Order-no.

Inhalt
Content

TX 20 - 25 - 27 -
30 - 40 - 45

22-277020-9

BIT-Schraubendrehersatz ROBERTSON

- 7-teilig
- mit Magnetbithalter
- in Bitbox

BIT screwdriver set ROBERTSON

- set of 7 pieces
- with magnetic bit holder
- in box



Bestell-Nr.
Order-no.

22-277030-9

Inhalt
Content

0
2 x 1
2 x 2
3

BIT-Steckgriff

- für Bits 6,35 mm (1/4")
- mit flexibler Klinge
- Innen 6-kant magnetisch
- mit blauem Kunststoffheft

BIT screwdriver handle

- for bits 6,35 mm (1/4")
- with flexible shaft
- with magnetic hexagonal inside
- blue plastic handle



Bestell-Nr.
Order-no.

22-280025-0

22-280030-0

Länge mm
Length mm

260

300

ABS-Box

- 26-teilig
- Bits mit Farbring
- 1/4" Steckschlüssel
- Knarre

ABS-Box

- 26 pieces
- bits with colored ring
- 1/4" socket
- with ratchet



Bestell-Nr.
Order-no.

22-278000-9

Inhalt
Content

PH 1, 2, 3
PZ 1, 2, 3
Schlitz/Slot 4,5 - 5,5 - 6,5
Hex 3 - 4 - 5 - 6
TX 10 - 15 - 20 - 25 - 30
Steckschlüssel/Socket SW6 - 7 - 8 - 10 - 13
Verlängerung/Extension
Knarre/Ratched 1/4"

BIT-Steckgriff-Schraubendreher

- für Bits 6,35 mm (1/4")
- mit 2-Komponenten-Griff

BIT screwdriver handle

- for bits 6,35 mm (1/4")
- with 2-component handle



Bestell-Nr.
Order-no.

22-280100-0

Länge mm
Length mm

200

Schlauchschellendreher

- mit 6-kant Aufnahme
- flexible Welle
- Kunststoffheft

Hose clip screwdriver

- hexagonal tip
- flexible shank
- plastic handle



Bestell-Nr. Order-no.	Abmessung mm Size mm	Länge mm Length mm
22-281005-0	5	260
22-281006-0	6	260
22-281007-0	7	260
22-281008-0	8	260
22-281009-0	9	260
22-281010-0	10	260

Magnethalter für BIT's

- SW 1/4"-E 6.3
- Chrom-Vanadium

Magnetic holder

- 1/4"-E 6.3
- Chrom-Vanadium



Bestell-Nr. Order-no.	Länge mm Length mm
22-282060-0	60
22-283074-0	74

Magnethalter

- 1/4"-E 6.3
- Werkzeugstahl
- verchromte Hülse

Magnetic holder

- 1/4"-E 6.3
- drop forged steel
- sleeve chromium plated



Bestell-Nr. Order-no.	Abmessung mm Length mm
22-282058-9	58

Schlagschrauber

- mit vier Klingen
- im Metalletui

Impact screwdriver

- with four bits
- in metal box



Bestell-Nr. Order-no.	Artikel Item	Inhalt Content
22-288000-9	Schlagschrauber Impact screwdriver	8-10 mm PH 2-3
22-289000-9	Ersatzklingenset spare blade set	

T-Griff Steckschlüssel

- vernickelt
- mit Kunststoffheft

T-handle socket nutdriver

- nickel plated
- plastic handle



Bestell-Nr. Order-no.	SW Size	Klingenlänge Blade length
22-290005-0	5 mm	230 mm
22-290055-0	5,5 mm	230 mm
22-290006-0	6 mm	230 mm
22-290007-0	7 mm	230 mm
22-290008-0	8 mm	230 mm
22-290009-0	9 mm	230 mm
22-290010-0	10 mm	230 mm
22-290011-0	11 mm	230 mm
22-290012-0	12 mm	230 mm
22-290013-0	13 mm	230 mm
22-290014-0	14 mm	230 mm
22-290015-0	15 mm	230 mm
22-290016-0	16 mm	230 mm
22-290017-0	17 mm	230 mm
22-291012-0	1/2"	230 mm
22-291014-0	1/4"	230 mm

Steckschlüssel-Schraubendreher

- vernickelt
- mit Kunststoffheft

Socket nutdriver

- nickel plated
- plastic handle



Bestell-Nr. Order-no.	SW Size	Klingenlänge Blade length
22-292035-0	3,5 mm	125 mm
22-292004-0	4 mm	125 mm
22-292045-0	4,5 mm	125 mm
22-292005-0	5 mm	125 mm
22-292055-0	5,5 mm	125 mm
22-292006-0	6 mm	125 mm
22-292007-0	7 mm	125 mm
22-292008-0	8 mm	125 mm
22-292009-0	9 mm	125 mm
22-292010-0	10 mm	125 mm
22-292011-0	11 mm	125 mm
22-292012-0	12 mm	125 mm
22-292013-0	13 mm	125 mm
22-292014-0	14 mm	125 mm
22-292015-0	15 mm	125 mm
22-292016-0	16 mm	125 mm
22-292017-0	17 mm	125 mm
22-293001-0	1/2"	125 mm
22-293002-0	1/4"	125 mm
22-293003-0	1/8"	125 mm
22-293004-0	11/32"	125 mm
22-293005-0	13/32"	125 mm
22-293006-0	19/32"	125 mm
22-293007-0	3/16"	125 mm
22-293008-0	3/8"	125 mm
22-293009-0	5/16"	125 mm
22-293010-0	5/32"	125 mm
22-293011-0	5/8"	125 mm
22-293012-0	7/16"	125 mm
22-293013-0	7/32"	125 mm
22-293014-0	9/16"	125 mm
22-293015-0	9/32"	125 mm



Stiftschlüssel ISO 2936

- schwarze Ausführung
- WS

Allen key ISO 2936

- black finish
- tool steel



Bestell-Nr. Order-no.	Größe mm Size mm	Bestell-Nr. Order-no.	Größe Zoll Size inch
22-300001-0	1,5	22-302001-0	3/64
22-300002-0	2	22-302003-0	1/16
22-300025-0	2,5	22-302004-0	5/64
22-300003-0	3	22-302005-0	3/32
22-300035-0	3,5	22-302006-0	7/64
22-300004-0	4	22-302007-0	1/8
22-300045-0	4,5	22-302008-0	9/64
22-300005-0	5	22-302009-0	5/32
22-300055-0	5,5	22-302010-0	3/16
22-300006-0	6	22-302011-0	7/32
22-300007-0	7	22-302012-0	1/4
22-300008-0	8	22-302013-0	9/32
22-300009-0	9	22-302014-0	5/16
22-300010-0	10	22-302015-0	11/32
22-300011-0	11	22-302016-0	3/8
22-300012-0	12	22-302017-0	7/16
22-300013-0	13	22-302018-0	1/2
22-300014-0	14	22-302019-0	9/16
22-300015-0	15	22-302020-0	5/8
22-300016-0	16	22-302021-0	3/4
22-300017-0	17	22-302022-0	7/8
22-300018-0	18	22-302023-0	1
22-300019-0	19		
22-300020-0	20		
22-300021-0	21		
22-300022-0	22		
22-300024-0	24		
22-300027-0	27		
22-300030-0	30		
22-300032-0	32		

Stiftschlüsselsatz ISO 2936

- schwarze Ausführung
- in Tasche
- WS

Allen key set ISO 2936

- black finish
- in wallet
- tool steel



Bestell-Nr. Order-no.	Größe Size	Teile Pieces
22-304008-0	1,5- 6 mm	8
22-304010-0	1,5-10 mm	10
22-304012-0	2,0-12 mm	12
22-306001-0	1/16-1/4"	8
22-306002-0	1/16-3/8"	10
22-306004-0	1/16-1/2"	11

Stiftschlüsselsatz am Ring ISO 2936

- schwarze Ausführung
- in Tasche
- WS

Allen key set ISO 2936

- on ring
- black finish
- tool steel



Bestell-Nr. Order-no.	Größe Size	Teile Pieces
22-308008-0	1,5- 6 mm	8
22-308010-0	1,5-10 mm	10
22-308012-0	2,0-12 mm	9
22-310008-0	1/16-1/4"	8
22-310010-0	1/16-3/8"	10
22-310012-0	1/16-1/2"	12

Stiftschlüssel ISO 2936

- schwarze Ausführung
- Chrom-Vanadium

Allen key ISO 2936

- black finish
- Chrom-Vanadium



Bestell-Nr. Order-no.	Größe mm Size mm	Bestell-Nr. Order-no.	Größe Zoll Size inch
22-312001-0	1,5	22-315001-0	3/64
22-312002-0	2	22-315003-0	1/16
22-312025-0	2,5	22-315004-0	5/64
22-312003-0	3	22-315005-0	3/32
22-312035-0	3,5	22-315006-0	7/64
22-312004-0	4	22-315007-0	1/8
22-312045-0	4,5	22-315008-0	9/64
22-312005-0	5	22-315009-0	5/32
22-312055-0	5,5	22-315010-0	3/16
22-312006-0	6	22-315011-0	7/32
22-312007-0	7	22-315012-0	1/4
22-312008-0	8	22-315013-0	9/32
22-312009-0	9	22-315014-0	5/16
22-312010-0	10	22-315015-0	11/32
22-312011-0	11	22-315016-0	3/8
22-312012-0	12	22-315017-0	7/16
22-312013-0	13	22-315018-0	1/2
22-312014-0	14	22-315019-0	9/16
22-312015-0	15	22-315020-0	5/8
22-312016-0	16	22-315021-0	3/4
22-312017-0	17	22-315022-0	7/8
22-312018-0	18	22-315023-0	1
22-312019-0	19		
22-312020-0	20		
22-312021-0	21		
22-312022-0	22		
22-312024-0	24		
22-312027-0	27		
22-312030-0	30		
22-312032-0	32		

Stiftschlüssel ISO 2936

- vernickelt
- Chrom-Vanadium

Allen key ISO 2936

- nickel plated
- Chrom-Vanadium

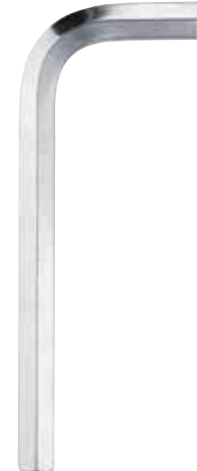

Bestell-Nr, Order-no,	Größe mm Size mm	Bestell-Nr, Order-no,	Größe mm Size mm
22-313001-0	1,0	22-313009-0	9,0
22-313015-0	1,5	22-313010-0	10,0
22-313002-0	2,0	22-313011-0	11,0
22-313025-0	2,5	22-313012-0	12,0
22-313003-0	3,0	22-313013-0	13,0
22-313035-0	3,5	22-313014-0	14,0
22-313004-0	4,0	22-313115-0	15,0
22-313045-0	4,5	22-313016-0	16,0
22-313005-0	5,0	22-313017-0	17,0
22-313055-0	5,5	22-313018-0	18,0
22-313006-0	6,0	22-313019-0	19,0
22-313007-0	7,0	22-313020-0	20,0
22-313008-0	8,0		



Stiftschlüssel ISO 2936 L

- schwarz
- lange Ausführung
- Chrom-Vanadium

Allen key ISO 2936 L

- black finish
- extra long
- Chrom-Vanadium

Bestell-Nr. Order-no.	Größe mm Size mm	Bestell-Nr. Order-no.	Größe Zoll Size inch
22-317015-0	1,5	22-319001-0	1/16
22-317002-0	2,0	22-319002-0	5/64
22-317025-0	2,5	22-319003-0	3/32
22-317003-0	3,0	22-319004-0	1/8
22-317035-0	3,5	22-319005-0	9/64
22-317004-0	4,0	22-319006-0	5/32
22-317045-0	4,5	22-319007-0	3/16
22-317005-0	5,0	22-319008-0	7/32
22-317055-0	5,5	22-319009-0	1/4
22-317006-0	6,0	22-319010-0	9/32
22-317007-0	7,0	22-319011-0	5/16
22-317008-0	8,0	22-319012-0	11/32
22-317009-0	9,0	22-319013-0	3/8
22-317010-0	10	22-319014-0	7/16
22-317011-0	11	22-319015-0	1/2
22-317012-0	12	22-319016-0	9/16
22-317013-0	13	22-319017-0	5/8
22-317014-0	14	22-319018-0	3/4
22-317017-0	17	22-319019-0	7/8
22-317019-0	19	22-319020-0	1
22-317022-0	22		



Stiftschlüsselsatz ISO 2936

- in Tasche
- vernickelt
- Chrom-Vanadium

Allen key set ISO 2936

- in wallet
- nickel plated
- Chrom-Vanadium



Bestell-Nr. Order-no.	Abmessung Size	Teile Pieces
22-322000-0	2,0- 6 mm	6
22-322001-0	2,0-10 mm	8
22-322002-0	2,0-14 mm	10
22-322003-0	0,05-1/4"	8
22-322004-0	0,05-3/8"	10

Stiftschlüssel ISO 2936 L

- in Tasche
- vernickelt
- Chrom-Vanadium

Allen key ISO 2936 L

- nickel plated
- extra long
- Chrom-Vanadium

Bestell-Nr. Order-no.	Größe mm Size mm	Bestell-Nr. Order-no.	Größe mm Size mm
22-318015-0	1,5	22-318008-0	8,0
22-318002-0	2,0	22-318009-0	9,0
22-318025-0	2,5	22-318010-0	10
22-318003-0	3,0	22-318011-0	11
22-318035-0	3,5	22-318012-0	12
22-318004-0	4,0	22-318013-0	13
22-318045-0	4,5	22-318014-0	14
22-318005-0	5,0	22-318017-0	17
22-318055-0	5,5	22-318019-0	19
22-318006-0	6,0	22-318022-0	22
22-318007-0	7,0		

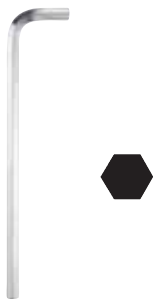

Stiftschlüsselsatz am Ring ISO 2936

- in Tasche
- vernickelt
- Chrom-Vanadium

Allen key set on ring ISO 2936

- in wallet
- nickel plated
- Chrom-Vanadium



Bestell-Nr. Order-no.	Abmessung Size	Teile Pieces
22-328006-0	2,0- 6 mm	6
22-328008-0	2,0-10 mm	8
22-330008-0	5/64-1/4"	6
22-330010-0	5/64-3/8"	8





Stiftschlüsselsatz ISO 2936

- in Tasche
- vernickelt
- Chrom-Vanadium

Allen key set ISO 2936

- in pvc wallet
- nickel plated
- Chrom-Vanadium



Bestell-Nr. Order-no.	Abmessung Size	Teile Pieces
22-336008-0	2-10 mm	8

Stiftschlüssel im Halter

- vernickelt
- Chrom-Vanadium

Allen key set in clip holder

- nickel plated
- Chrom-Vanadium



Bestell-Nr. Order-no.	Abmessung Size	Teile Pieces
22-333006-0	1,5- 6 mm	7
22-333010-0	2,5-10 mm	7

Stiftschlüsselsatz ISO 2936

- in Tasche
- vernickelt
- Chrom-Vanadium

Allen key set ISO 2936

- in pvc wallet
- black finish
- Chrom-Vanadium



Bestell-Nr. Order-no.	Abmessung Size	Teile Pieces
22-336110-0	1,5-10 mm	10
22-336210-0	0,05-3/8"	10

Stiftschlüsselsatz ISO 2936

- in SB-Clip
- vernickelt
- Chrom-Vanadium

Allen key sets ISO 2936

- on clip
- nickel plated
- Chrom-Vanadium



Bestell-Nr. Order-no.	Abmessung mm Size mm	Teile Pieces
22-337007-0	1,5- 6	7
22-337009-0	1,5-10	9
22-337010-0	1,5-12	10

Stiftschlüsselsatz ISO 2936

- lange Ausführung
- schwarz
- in SB-Tasche
- Chrom-Vanadium

Allen key sets ISO 2936

- long type
- black finish
- in wallet
- Chrom-Vanadium



Bestell-Nr. Order-no.	Abmessung mm Size mm	Teile Pieces
22-338506-0	2- 6	6
22-338508-0	2-10	8

Stiftschlüsselsatz ISO 2936

- in SB-Clip
- vernickelt
- Chrom-Vanadium

Allen key sets ISO 2936

- on clip
- nickel plated
- Chrom-Vanadium



Bestell-Nr. Order-no.	Abmessung mm Size mm	Teile Pieces
22-337107-0	1,5- 6	7
22-337109-0	1,5-10	9
22-337110-0	1,5-12	10

Stiftschlüsselsatz ISO 2936

- lange Ausführung
- in SB-Tasche
- vernickelt
- Chrom-Vanadium

Allen key sets ISO 2936

- long type
- in wallet
- nickel plated
- Chrom-Vanadium



Bestell-Nr. Order-no.	Abmessung mm Size mm	Teile Pieces
22-338706-0	2- 6	6
22-338708-0	2-10	8

Stiftschlüsselsatz ISO 2936 L

- lange Ausführung
- im SB-Clip
- vernickelt
- Chrom-Vanadium

Allen key set ISO 2936 L

- long type
- nickel plated
- on clip
- Chrom-Vanadium



Bestell-Nr. Order-no.	Abmessung Size	Teile Pieces
22-339009-0	1,5-10 mm	9
22-339109-0	1/16-3/8"	9

Stiftschlüsselsatz mit Kugelkopf

- lange Ausführung
- im SB-Clip
- vernickelt
- Chrom-Vanadium

Allen key set with ball head

- long type
- nickel plated
- on clip
- Chrom-Vanadium



Bestell-Nr. Order-no.	Abmessung Size	Teile Pieces
22-348007-0	1,5- 6 mm	7
22-348009-0	1,5-10 mm	9
22-348010-0	1,5-12 mm	10
22-348207-0	1/16-1/4"	7
22-348213-0	0,05-3/8"	13

Stiftschlüsselsatz ISO 2936 L

- lange Ausführung
- im SB-Clip
- vernickelt
- Chrom-Vanadium

Allen key set ISO 2936 L

- long type
- nickel plated
- on clip
- Chrom-Vanadium



Bestell-Nr. Order-no.	Abmessung Size	Teile Pieces
22-339509-0	1,5-10 mm	9
22-339609-0	1/16-3/8"	9

Stiftschlüsselsatz mit Kugelkopf

- lange Ausführung
- im SB-Clip
- vernickelt
- Chrom-Vanadium

Allen key set with ball head

- long type
- nickel plated
- on clip
- Chrom-Vanadium



Bestell-Nr. Order-no.	Abmessung Size	Teile Pieces
22-348507-0	1,5- 6 mm	7
22-348509-0	1,5-10 mm	9
22-348510-0	1,5-12 mm	10
22-348707-0	1/16-1/4"	7
22-348713-0	0,05-3/8"	13

Stiftschlüssel-Schraubendreher

- Klinge vernickelt
- 2-Komponenten-Heft
- Chrom-Vanadium

Allen key-screwdriver

- blade nickel plated
- with 2-component handle
- Chrom-Vanadium



Bestell-Nr. Order-no.	Abmessung mm Size mm	Klingenlänge mm Blade length mm
22-354002-0	2,0	60
22-354025-0	2,5	75
22-354003-0	3,0	75
22-354004-0	4,0	75
22-354005-0	5,0	75
22-354006-0	6,0	100

Stiftschlüssel zur Fenstermontage

- Klinge vernickelt
- 2-Komponenten-Heft
- Chrom-Vanadium

Allen key for window fitting

- blade nickel plated
- 2-component handle
- Chrom-Vanadium



Bestell-Nr. Order-no.	Abmessung mm Size mm	Klingenlänge mm Blade length mm
22-354125-0	2,5	150

T-Griff-Stiftschlüsseldreher

- mit kurzer und langer Klinge
- 2-Komponenten-Heft
- Chrom-Vanadium

T-handle allen key

- with short and long blade
- 2-component handle
- Chrom-Vanadium



Bestell-Nr. Order-no.	Abmessung mm Size mm	Klingenlänge mm Blade length mm
22-355020-0	2,0	125
22-355025-0	2,5	125
22-355030-0	3,0	125
22-355040-0	4,0	125
22-355050-0	5,0	150
22-355060-0	6,0	150
22-355080-0	8,0	175
22-355010-0	10,0	175

T-Griff-Stiftschlüsseldreher

- vernickelt
- Chrom-Vanadium

T-handle allen key

- nickel plated
- Chrom-Vanadium



Bestell-Nr. Order-no.	Abmessung mm Size mm	Klingenlänge mm Blade length mm
22-356001-0	2,5	100
22-356002-0	3,0	100
22-356003-0	3,0	150
22-356004-0	4,0	100
22-356005-0	4,0	150
22-356006-0	4,0	200
22-356007-0	5,0	100
22-356008-0	5,0	150
22-356009-0	5,0	200
22-356010-0	6,0	100
22-356011-0	6,0	150
22-356012-0	6,0	200
22-356013-0	8,0	100
22-356014-0	8,0	150
22-356015-0	8,0	200
22-356016-0	10,0	100
22-356017-0	10,0	200
22-356018-0	12,0	100
22-356019-0	12,0	200

TORX® Stiftschlüssel

- stahlgrau
- Chrom-Vanadium

TORX® key wrench

- steel grey
- Chrom-Vanadium



Bestell-Nr. Order-no.	Abmessung TX Size TX
22-360006-0	6
22-360007-0	7
22-360008-0	8
22-360009-0	9
22-360010-0	10
22-360015-0	15
22-360020-0	20
22-360025-0	25
22-360027-0	27
22-360030-0	30
22-360040-0	40
22-360045-0	45
22-360050-0	50
22-360055-0	55
22-360060-0	60

TORX® T-Griff-Stiftschlüsseldreher

- 2-Komponenten-Heft
- mit kurzer und langer Klinge
- Chrom-Vanadium

TORX® T-handle allen key

- 2-component handle
- with short and long blade
- Chrom-Vanadium

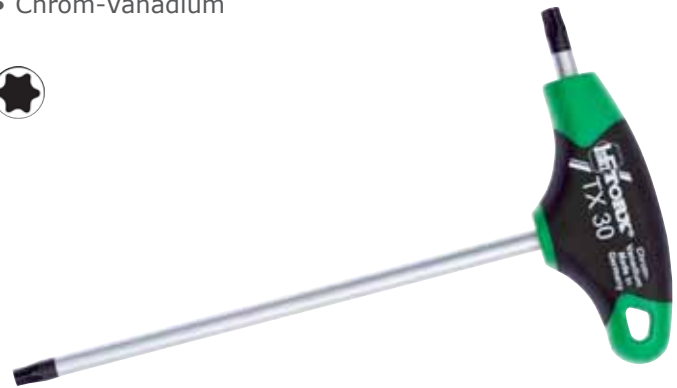

Bestell-Nr. Order-no.	Abmessung TX Size TX	Klingenlänge mm Blade length mm
22-364009-0	9	100
22-364010-0	10	100
22-364015-0	15	100
22-364020-0	20	150
22-364025-0	25	150
22-364027-0	27	150
22-364030-0	30	150
22-364040-0	40	150

TAMPER-TORX® -Stiftschlüssel

- stahlgrau
- Chrom-Vanadium

**TAMPER-TORX®
key wrench**

- steel grey
- Chrom-Vanadium



Bestell-Nr. Order-no.	Abmessung TX Size TX
22-362009-0	9
22-362010-0	10
22-362015-0	15
22-362020-0	20
22-362025-0	25
22-362027-0	27
22-362030-0	30
22-362040-0	40



TORX®-Clip-Stiftschlüssel

- stahlgrau
- im Handklapphalter
- Chrom-Vanadium

TORX® key wrench set

- steel grey
- in clip
- Chrom-Vanadium



Bestell-Nr. Order-no.	Abmessung TX Size TX	Teile Pieces
22-366008-0	9-10-15-20-25-27-30-40	8

TORX®-Stiftschlüsselsatz

- schwarz
- in SB-Clip
- Chrom-Vanadium

TORX® key wrench set

- black
- on clip
- Chrom-Vanadium



Bestell-Nr. Order-no.	Abmessung TX Size TX	Teile Pieces
22-375000-9	9-10-15-20-25-27-30-40	8

TAMPER-TORX®-Stiftschlüssel

- stahlgrau
- im Handklapphalter
- Chrom-Vanadium

TAMPER-TORX® key wrench set

- steel grey
- in clip
- Chrom-Vanadium



Bestell-Nr. Order-no.	Abmessung TX Size TX	Teile Pieces
22-368008-0	9-10-15-20-25-27-30-40	8

TAMPER-TORX®-Stiftschlüsselsatz

- schwarz
- in SB-Clip
- Chrom-Vanadium

TAMPER-TORX® key wrench set

- black
- on clip
- Chrom-Vanadium



Bestell-Nr. Order-no.	Abmessung TX Size TX	Teile Pieces
22-375100-9	9-10-15-20-25-27-30-40	8

TORX®-Stiftschlüsselsatz

- schwarz
- am Ring
- in Tasche
- Chrom-Vanadium

TORX® key wrench set

- black
- on ring
- in wallet
- Chrom-Vanadium



Bestell-Nr. Order-no.	Abmessung TX Size TX	Teile Pieces
22-376000-9	9-10-15-20-25-27-30-40	8

TORX®-Stiftschlüsselsatz

- stahlgrau
- in SB-Clip
- Chrom-Vanadium

TORX® key wrench set

- steel grey
- on clip
- Chrom-Vanadium



Bestell-Nr. Order-no.	Abmessung TX Size TX	Teile Pieces
22-380000-0	9-10-15-20-25-27-30-40	8

TAMPER-TORX®-Stiftschlüsselsatz

- schwarz
- am Ring
- in Tasche
- Chrom-Vanadium

TAMPER-TORX® key wrench set

- black
- on ring
- in wallet
- Chrom-Vanadium



Bestell-Nr. Order-no.	Abmessung TX Size TX	Teile Pieces
22-376100-9	9-10-15-20-25-27-30-40	8

TAMPER-TORX®-Stiftschlüsselsatz

- stahlgrau
- in SB-Clip
- Chrom-Vanadium

TAMPER-TORX® key wrench set

- steel grey
- on clip
- Chrom-Vanadium



Bestell-Nr. Order-no.	Abmessung TX Size TX	Teile Pieces
22-381000-0	9-10-15-20-25-27-30-40	8



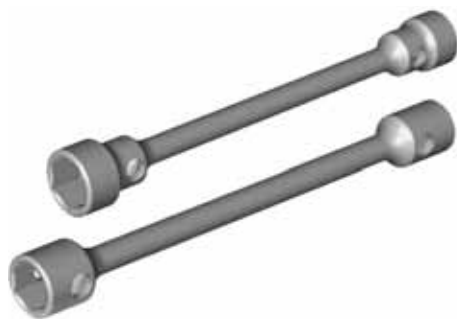

Radwechsel

Ventil-Schraubendreher	102
Mutterschlüssel	102
Drehmomentschlüssel	103
Wagenheber	120
Unterstellbock	120
Kompressor	121

Tyre exchange

Valve screwdriver	102
Wrenches	102
Torque wrenches	103
Bottle-/trolley jacks	120
Axel stands	120
Compressor	121



Motorwartung

Zündkerze	103
Ölwechsel	103-104
Kolbenring	104
Ventile	105-106

Engine maintenance

Spark plug	103
Oil exchange	103-104
Piston ring	104
Valve	105-106



Hämmer

Plastikhammer	106-107
Nylonhammer	106-107

Hammers

Plastic hammer	106-107
Nylon hammer	106-107



Diverse Schlüssel

Gabel-/Ringschlüssel	108-111
Ratschenschlüssel	108-109
Einmaulschlüssel	109
Schlagschlüssel	111
Haken-/Stirnlochschlüssel	111-112
Steckschlüssel	112-113
Magnetschlüssel	113

Divers Spanners

Open/Ring/Combination	108-111
Ratchet spanners	108-109
Single Spanners	109
Slogging spanners	111
Hook-/face spanners	111-112
Box spanners	112-113
Magnetic spanners	113



**Ratschen/
Steckschlüssel**

Drehmomentschlüssel	103
Ratschen	114, 116-118
Steckschlüssel	115, 117, 119
Sätze	114, 116

**Ratchets/
Sockets**

Torque wrenches	103
Ratchets	114, 116-118
Sockets	115, 117, 119
Sets	114, 116



Sonstiges

Bremsfederzange	105
Karosseriefeile	107
Werkzeugkoffer	120-121
Kraftstoffkanister	121

Others

Brake spring pliers	105
Coachwork file	107
Tool boxes	120-121
Fuel jerrycans	121

Reifen-Ventil-Schraubendreher

zum Ein- und Ausschrauben von Fahrrad- PKW- und LKW-Reifenventilen

Tyre-valve screwdriver

for in- and out-screwing of bicycle, car and truck valves



Bestell-Nr. Order-no.	Abmessung mm Size mm	Länge mm Length mm
23-100513-9	4 + 6	160

Drehstange

- zu Radmutterenschlüsseln
- stahlgrau

Tommy bar

- for rim wrenches
- steel grey



Bestell-Nr. Order-no.	Länge mm Length mm	Ø mm Ø mm
23-102550-0	500	18
23-102560-0	600	18

Radmutter Schlüssel für PKW/LKW

- ohne Drehstange
- stahlgrau

Car and truck rim wrench

- without tommy bar
- steel grey

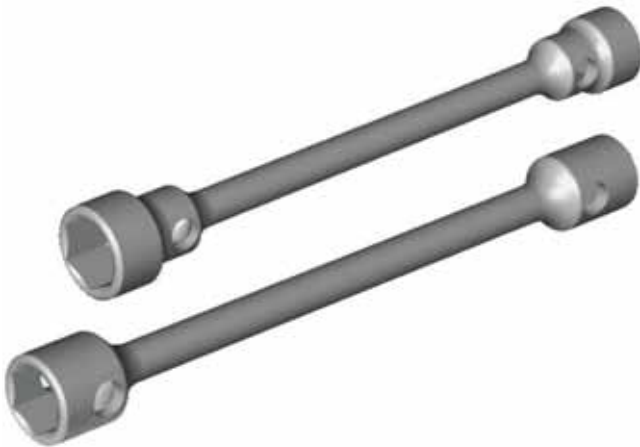

Bestell-Nr. Order-no.	Abmessung mm Size mm
23-101501-0	17 x 19
23-101502-0	22 x 27
23-101503-0	27 x 30
23-101504-0	27 x 32 + 21 4-kant
23-101505-0	28 x 33
23-101506-0	30 x 32
23-101507-0	32 x 33
23-101508-0	32 x 38 + 21 4-kant
23-101509-0	19 x 22
23-101510-0	24 x 27
23-101511-0	22 x 24
23-101514-0	30 x 33

Kreuzschlüssel

- für PKW und LKW
- silberfarbig

Four way rim wrench

- for cars and trucks
- silver coloured



Bestell-Nr. Order-no.	Abmessung mm/Zoll Size mm/inch
23-103501-9	17 x 19 x 22 x 13/16
23-103502-9	17 x 19 x 22 + 1/2
23-103503-9	24 x 27 x 32 + 3/4
23-103504-0	24 x 27 x 32 x 38

Radmutter Schlüssel

- Einsatz drehbar
- mit Gummigriff
- ausziehbar bis 550 mm

Rim wrench for cars

- socket turnable
- with rubber handle
- extendable up to 550 mm



Bestell-Nr. Order-no.	Abmessung mm Size mm	Antrieb Zoll drive inch
23-104055-9	17 + 19	1/2

Drehmomentschlüssel

- Hebel-Umschaltknarre mit automatischer Auslösung
- Klicksignal
- in Kunststoffbox

Automatic torque wrench

- lever reversible, with automatic release
- with click-signal
- in plastic case



Bestell-Nr. Order-no.	Messbereich Nm Measuring area Nm	Antrieb Zoll drive inch
23-105514-9	5-25	1/4
23-105512-9	30-210	1/2 + adapter 3/8

Zündkerzenschlüssel

- drehbar
- mit isoliertem T-Griff

Spark plug wrench

- turnable
- insulated T-handle



Bestell-Nr. Order-no.	Schlüsselweite mm Size mm
23-108016-9	16
23-108021-9	21

PROFI Drehmomentschlüssel

Hebelumschaltknarre mit automatischer Klick-Auslösung

- Quick-Lock Schnellarretierung
- hohe Genauigkeit
- in Kunststoffbox

PROFI automatic torque wrench

lever reversible, with automatic release

- with fast lock
- high accuracy
- with click-signal
- in plastic case



Bestell-Nr. Order-no.	Messbereich Nm Measuring area Nm	Antrieb Zoll drive inch
23-106506-9	6-30	1/4"
23-106519-9	19-110	3/8"
23-106540-9	40-210	1/2"
23-106570-9	70-350	1/2"
23-106510-9	100-500	3/4"
23-106514-9	140-980	1"

Zündkerzenbürste

- Messingdraht
- Holzgriff

Spark plug brush

- all brass wire
- wooden handle

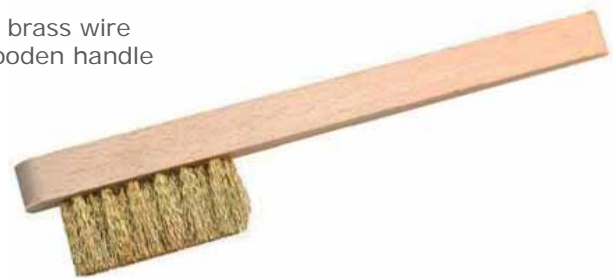

Bestell-Nr. Order-no.	Reihen rows
23-110000-0	3 x 6

Ölfilter-Bandschlüssel

- vernickelt
- Griff isoliert

Oil filter strap key

- nickel plated
- handle insulated



Bestell-Nr. Order-no.	Spannbereich Ø mm Capacity Ø mm
23-112016-0	160
23-112024-0	240
23-112116-0	160/730 - Ersatzband/replacement strap
23-112124-0	240/920 - Ersatzband/replacement strap

Kettenschlüssel

- für Ölfilter bis Ø 120 mm
- Rechts- und Linksanzug

Chain wrench

- for oil filters up to Ø 120 mm
- right- and left hand use



Bestell-Nr. Order-no.	Kette mm Chain mm	Antrieb Zoll drive inch
23-112512-0	400	1/2

Öldienstschlüssel

- 10 Abmessungen
- verchromt
- Chrom-Vanadium

Drain plug wrench

- 10 different sizes
- chrome plated
- Chrom-Vanadium



Bestell-Nr. Order-no.	Länge mm Length mm
23-113522-0	220

Spezial Ölwanenschlüssel

- vierkant an beiden Seiten
- verchromt

Oil drain plug wrench

- square-end on both sides
- chrome plated



Bestell-Nr. Order-no.	Abmessung mm Size mm
23-114010-9	8 x 10

Kolbenringspannband

stufenlos verstellbar

Piston ring tightening strap

stepless adjustable



Bestell-Nr. Order-no.	Gr. Size	Spannbereich mm Capacity mm	Höhe mm Height mm
23-115001-0	0	40-75	50
23-115002-0	1	57-125	80
23-115003-0	1a	57-125	100
23-115004-0	2	90-175	80
23-115005-0	2a	90-175	100
23-115006-0	3	90-175	165

Kolbenringzange

- vernickelt
- Griff isoliert

Piston ring pliers

- nickel plated
- handle insulated



Bestell-Nr. Order-no.	Spannweite mm Capacity mm
23-115510-0	50-100
23-115515-0	90-150

Ventilfeder Spannapparat

- für PKW, LKW, Bus und Traktor
- mit geraden bzw. gebogenen Backen
- vernickelt
- Griff isoliert

Valve lifters

- for car, truck, bus and tractor
- with straight and bent jaws
- nickel plated
- handle insulated



Bestell-Nr. Order-no.	Spannbereich mm Capacity mm	Länge mm Length mm	Einsatz bei Use for
23-116029-0	70-225	290	PKW
23-116589-0	85-280	390	LKW/Bus/Traktor

Bremsfederzange

- vernickelt
- Chrom-Vanadium

Brake spring pliers

- nickel plated
- Chrom-Vanadium



Bestell-Nr. Order-no.	Länge mm Length mm
23-118521-0	215
23-119534-0	340

Frostschutztester HYDRO-TEMP

- für Ethylenglykol-Wassermischungen ab 0° bis -40°C
- mit Ansaugschlauch 185 x 6 mm

HYDROTEMP Anti-Freeze-Tester

- for ethylene glycol water mixture, 0° to -40°C
- with suction hose 185 x 6 mm



Best.-Nr. Order-no.
23-118000-0



Ventileinschleifer

mit Holzstiel

Valve grinder

with wooden handle



Bestell-Nr.	Artikel	Saugnapf Ø mm	Länge mm
Order-no.	Item	Cap Ø mm	Length mm
23-126520-0	Ventilschleifer/Valve grinder	20	280
23-126525-0	Ventilschleifer/Valve grinder	25	280
23-126530-0	Ventilschleifer/Valve grinder	30	280
23-126537-0	Ventilschleifer/Valve grinder	37	280
23-127000-0	Ersatz-Stiel/spare handle		250
23-127520-0	Ersatz-Saugnapf/spare cap	20	
23-127525-0	Ersatz-Saugnapf/spare cap	25	
23-127530-0	Ersatz-Saugnapf/spare cap	30	
23-127537-0	Ersatz-Saugnapf/spare cap	37	

Kunststoff-Plastikhammer

mit lackiertem Eschenstiel

Plastic hammer

with ash wood handle



Bestell-Nr.	Kopf Ø mm	Farbe
Order-no.	Head Ø mm	Colour
23-137022-0	22	rot/red
23-137027-0	27	rot/red
23-137032-0	32	rot/red
23-137035-0	35	rot/red
23-137040-0	40	rot/red
23-137050-0	50	rot/red
23-137060-0	60	rot/red
23-137522-0	22	gelb/yellow
23-137527-0	27	gelb/yellow
23-137532-0	32	gelb/yellow
23-137535-0	35	gelb/yellow
23-137540-0	40	gelb/yellow
23-137550-0	50	gelb/yellow
23-137560-0	60	gelb/yellow

Nylon-Hammer

- mit weißen Köpfen
- mit Eschenstiel

Nylon hammer

- with white heads
- ash wood handle



Bestell-Nr.	Kopf Ø mm
Order-no.	Head Ø mm
23-139522-0	22
23-139527-0	27
23-139532-0	32
23-139535-0	35
23-139540-0	40
23-139550-0	50
23-139560-0	60

Ersatzkopf

Spare head



Bestell-Nr. Order-no.	Ø mm Ø mm	Farbe Colour
23-138022-0	22	rot/red
23-138027-0	27	rot/red
23-138032-0	32	rot/red
23-138035-0	35	rot/red
23-138040-0	40	rot/red
23-138050-0	50	rot/red
23-138060-0	60	rot/red
23-138522-0	22	gelb/yellow
23-138527-0	27	gelb/yellow
23-138532-0	32	gelb/yellow
23-138535-0	35	gelb/yellow
23-138540-0	40	gelb/yellow
23-138550-0	50	gelb/yellow
23-138560-0	60	gelb/yellow
23-139722-0	22	nylon
23-139727-0	27	nylon
23-139732-0	32	nylon
23-139735-0	35	nylon
23-139740-0	40	nylon
23-139750-0	50	nylon
23-139760-0	60	nylon



Karosserie-Feilenhalter

silberfarbig

Coachwork file holder

silver coloured

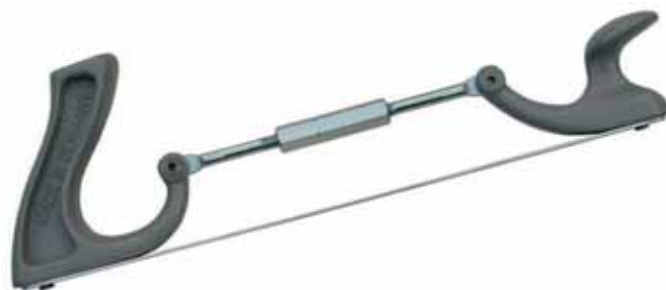

Bestell-Nr. Order-no.	Länge mm Length mm
23-140000-0	350

Ersatz-Holzstiel

für Plastik- und Nylonhammer aus Eschenholz

Spare ash wood handle

für plastic- and nylon hammer



Bestell-Nr. Order-no.	Für Hammer Ø mm For hammers Ø mm
23-139022-0	22
23-139027-0	27
23-139032-0	32
23-139035-0	35
23-139040-0	40
23-139050-0	50
23-139060-0	60

Karosserie-Feilenblatt

radial verzahnt

Coachwork file

radial teethed



Bestell-Nr. Order-no.	Länge mm Length mm	Zahnung je Zoll teeth per inch
23-141015-0	350	15/fein/fine
23-142012-0	350	12/mittel/2nd cut
23-143009-0	350	9/grob/coarse

Gabelschlüssel DIN 3110

- verchromt
- Chrom-Vanadium

Double open end spanner DIN 3110

- chromium plated
- Chrom-Vanadium



Bestell-Nr. Order-no.	Schlüsselweite mm Wrench size mm
23-149006-9	6 x 7
23-149008-9	8 x 9
23-149010-9	10 x 11
23-149012-9	12 x 13
23-149014-9	14 x 15
23-149016-9	16 x 17
23-149017-9	17 x 19
23-149018-9	18 x 19
23-149020-9	20 x 22
23-149021-9	21 x 23
23-149024-9	24 x 26
23-149025-9	25 x 28
23-149027-9	27 x 32

Gabelschlüsselsatz DIN 3110

- verchromt
- Chrom-Vanadium

Double open end spanner set DIN 3110

- chromium plated
- Chrom-Vanadium



Bestell-Nr. Order-no.	Schlüsselweite mm Wrench size mm	Satz teilig Pieces/Set
23-149517-9	6-17	6
23-149522-9	6-22	8
23-149526-9	6-26	10
23-149532-9	6-32	12

Ratschenring-Maulschlüssel

- feinverzahnt mit 72 Zähnen
- 12-kant
- verchromt
- Chrom-Vanadium

Combined ratchet spanner

- fine toothed with 72 teeth
- double hexagonal
- chromium plated
- Chrom-Vanadium



Bestell-Nr. Order-no.	Schlüsselweite mm Wrench size mm
23-160008-9	8
23-160009-9	9
23-160010-9	10
23-160011-9	11
23-160012-9	12
23-160013-9	13
23-160014-9	14
23-160015-9	15
23-160016-9	16
23-160017-9	17
23-160018-9	18
23-160019-9	19
23-160021-9	21
23-160022-9	22

Ratschenring-Maulschlüssel

- feinverzahnt mit 72 Zähnen
- 12-kant
- Kopf 90° stufenlos abwinkelbar
- verchromt
- Chrom-Vanadium

Combined ratchet spanner

- fine toothed with 72 teeth
- double hexagonal
- head 90° adjustable
- chromium plated
- Chrom-Vanadium



Bestell-Nr. Order-no.	Schlüsselweite mm Wrench size mm
23-161008-9	8
23-161009-9	9
23-161010-9	10
23-161011-9	11
23-161012-9	12
23-161013-9	13
23-161014-9	14
23-161015-9	15
23-161016-9	16
23-161017-9	17
23-161018-9	18
23-161019-9	19

Einmaulschlüssel

- nach DIN 894
- schwarze Ausführung

Single spanner

- according to DIN 894
- black finish



Bestell-Nr. Order-no.	Schlüsselweite mm Wrench size mm
23-162506-9	6
23-162507-9	7
23-162508-9	8
23-162509-9	9
23-162510-9	10
23-162511-9	11
23-162512-9	12
23-162513-9	13
23-162514-9	14
23-162515-9	15
23-162516-9	16
23-162517-9	17
23-162519-9	19
23-162522-9	22
23-162524-9	24
23-162527-9	27
23-162530-9	30
23-162532-9	32
23-162536-9	36
23-162541-9	41



Gabel-Ringschlüssel DIN 3113 A

- verchromt
- Chrom-Vanadium

Combined spanner DIN 3113 A

- chromium plated
- Chrom-Vanadium



Bestell-Nr. Order-no.	Schlüsselweite mm Wrench size mm
23-165006-9	6
23-165007-9	7
23-165008-9	8
23-165009-9	9
23-165010-9	10
23-165011-9	11
23-165012-9	12
23-165013-9	13
23-165014-9	14
23-165015-9	15
23-165016-9	16
23-165017-9	17
23-165018-9	18
23-165019-9	19
23-165020-9	20
23-165021-9	21
23-165022-9	22
23-165023-9	23
23-165024-9	24
23-165025-9	25
23-165026-9	26
23-165027-9	27
23-165028-9	28
23-165029-9	29
23-165030-9	30
23-165032-9	32
23-165034-9	34
23-165036-9	36
23-165038-9	38

Gabel-Ringschlüsselsatz DIN 3113 A

- verchromt
- Chrom-Vanadium

Combined spanner set DIN 3113 A

- chromium plated
- Chrom-Vanadium



Bestell-Nr. Order-no.	Schlüsselweite mm Wrench size mm	St./Satz Pieces/Set
23-165508-9	8-19	8
23-165512-9	6-22	12
23-165517-9	6-22	17
23-165525-9	6-32	25

Ringschlüssel DIN 838

- verchromt
- Chrom-Vanadium

Ring spanner DIN 838

- chromium plated
- Chrom-Vanadium



Bestell-Nr. Order-no.	Schlüsselweite mm Wrench size mm
23-172006-9	6 x 7
23-172008-9	8 x 9
23-172010-9	10 x 11
23-172012-9	12 x 13
23-172014-9	14 x 15
23-172016-9	16 x 17
23-172018-9	18 x 19
23-172020-9	20 x 22
23-172021-9	21 x 23
23-172024-9	24 x 26
23-172025-9	25 x 28
23-172027-9	27 x 32

Ringschlüsselsatz DIN 838

- verchromt
- Chrom-Vanadium

Ring spanner set DIN 838

- chromium plated
- Chrom-Vanadium



Bestell-Nr. Order-no.	Schlüsselweite mm Wrench size mm	St./Satz Pieces/Set
23-172517-9	6-17	6
23-172522-9	6-22	8
23-172526-9	6-27	10
23-172532-9	6-32	12

Schlagringschlüssel DIN 7444

schwarz

Ring slogging spanner DIN 7444

black finish



Bestell-Nr. Order-no.	Schlüsselweite mm Wrench size mm
23-177030-9	30
23-177032-9	32
23-177034-9	34
23-177036-9	36
23-177041-9	41
23-177045-9	45
23-177046-9	46
23-177050-9	50
23-177055-9	55
23-177060-9	60
23-177070-9	65

Schlagmaulschlüssel DIN 133

schwarz

Open end slogging spanner DIN 133

black finish



Bestell-Nr. Order-no.	Schlüsselweite mm Wrench size mm
23-176530-9	30
23-176532-9	32
23-176534-9	34
23-176536-9	36
23-176541-9	41
23-176545-9	45
23-176546-9	46
23-176550-9	50
23-176555-9	55
23-176560-9	60
23-176565-9	65

Hakenschlüssel DIN 1810 A

- mit Nase
- für Nutmuttern DIN 1804
- brüniert

Hook spanner DIN 1810 A

- with nose
- for grooved nuts DIN 1804
- black finish



Bestell-Nr. Order-no.	Schlüsselweite mm Wrench size mm	Länge mm Length mm
23-178516-0	40- 42	170
23-178517-0	45- 50	205
23-178518-0	52- 55	205
23-178519-0	58- 62	240
23-178520-0	68- 75	240
23-178521-0	80- 90	280
23-178522-0	95-100	280

Stirnlochschlüssel

- verstellbar
- für Zweilochmuttern

Adjustable face spanner

- for nuts with 2 holes
- black finish



Bestell-Nr. Order-no.	Schlüsselweite mm Wrench size mm	Zapfen Ø mm pin Ø mm	Länge mm Length mm
23-179002-0	7- 40	2	115
23-179003-0	11- 60	3	160
23-179004-0	11- 60	4	160
23-179005-0	14-100	5	215
23-179006-0	14-100	6	215
23-179008-0	22-125	8	260

Rohrsteckschlüssel

- ähnlich DIN 896
- glanzchromatisiert

Tubular box spanner

- similar to DIN 896
- bright zinc plated



Bestell-Nr. Order-no.	Schlüsselweite mm Wrench size mm
23-180001-0	6 x 7
23-180002-0	8 x 9
23-180003-0	8 x 10
23-180005-0	9 x 11
23-180006-0	10 x 11
23-180012-0	12 x 13
23-180013-0	12 x 14
23-180015-0	13 x 15
23-180016-0	13 x 17
23-180017-0	14 x 15
23-180018-0	14 x 17
23-180019-0	16 x 17
23-180020-0	16 x 18
23-180021-0	17 x 19
23-180022-0	18 x 19
23-180023-0	19 x 22
23-180025-0	20 x 22
23-180026-0	21 x 23
23-180027-0	22 x 24
23-180028-0	24 x 26
23-180029-0	24 x 27
23-180031-0	25 x 28
23-180032-0	27 x 32
23-180034-0	30 x 32
23-180035-0	30 x 36
23-180036-0	32 x 36
23-180037-0	36 x 41
23-180038-0	41 x 46
23-180039-0	46 x 50



Rohrsteckschlüsselsatz

- ähnlich DIN 896
- glanzchromatisiert

Tubular box spanner set

- similar to DIN 896
- bright zinc plated



Bestell-Nr. Order-no.	Schlüsselweite mm Wrench size mm	St./Satz Pieces/Set	Drehstangen St. Rotating bar Pieces
23-181006-0	6-17	6	2
23-181008-0	6-22	8	4
23-181009-0	6-27	9	4
23-181012-0	6-32	12	5

T-Griff-Steckschlüssel

- mit Gelenkkopf
- 6-kant
- verchromt
- Chrom-Vanadium

T-Handle socket

- hexagonal
- with adjustable head
- chromium plated
- Chrom-Vanadium



Bestell-Nr. Order-no.	Schlüsselweite mm Wrench size mm	Länge mm Length mm
23-182001-9	6	395
23-182002-9	7	395
23-182003-9	8	395
23-182004-9	9	400
23-182005-9	10	400
23-182006-9	11	400
23-182007-9	12	400
23-182008-9	13	432
23-182009-9	14	432
23-182010-9	15	450
23-182011-9	16	450
23-182012-9	17	450
23-182013-9	18	450
23-182015-9	19	500

Steckschlüssel extra lang

- mit T-Griff
- glanzchromatisiert

Tubular box spanner extra long

- with T-handle
- bright zinc plated



Bestell-Nr. Order-no.	Schlüsselweite mm Wrench size mm	Länge mm Length mm
23-180110-0	10	250
23-180112-0	12	250
23-180113-0	13	250

Magnetschlüssel am Ring

gehärtet und vernickelt

Magnet spanners on ring

hardened and nickel plated



Bestell-Nr. Order-no.	Schlüsselweite mm Wrench size mm	Satz teilig Pieces/Set
23-184000-0	4-7,5	11

Ratsche 1/4" DIN 3122

- umschaltbar
- mit rutschfestem Griff
- verchromt
- Chrom-Vanadium

Ratchet 1/4" DIN 3122

- reversible
- with anti-slip handle
- chromium plated
- Chrom-Vanadium



Bestell-Nr. Order-no.	Ausführung Execution	Länge mm Length mm
23-196500-9	gerade/straight	150
23-196501-9	ergonomisch/ergonomic	150

Ratsche 3/8" DIN 3122

- umschaltbar
- mit rutschfestem Griff
- verchromt
- Chrom-Vanadium

Ratchet 3/8" DIN 3122

- reversible
- with anti-slip handle
- chromium plated
- Chrom-Vanadium



Bestell-Nr. Order-no.	Ausführung Execution	Länge mm Length mm
23-206000-9	gerade/straight	200
23-206001-9	ergonomisch/ergonomic	200

Steckschlüsselsatz 1/4" SUPERLOCK

- inklusive Bit-Einsätze
- im Kunststoffkasten
- verchromt
- Chrom-Vanadium

Socket set 1/4" SUPERLOCK

- including bit sockets
- in case
- chromium plated
- Chrom-Vanadium



Bestell-Nr. Order-no.	Abmessung mm Size mm	Satz teilig Pieces/Set
23-200000-9	4-14	47

Steckschlüsselsatz 3/8" SUPERLOCK

- im Kunststoffkasten
- verchromt
- Chrom-Vanadium

Socket set 3/8" SUPERLOCK

- in case
- chromium plated
- Chrom-Vanadium



Bestell-Nr. Order-no.	Abmessung mm Size mm	Satz teilig Pieces/Set
23-210000-9	6-24	26

Steckschlüssel 1/2" SUPERLOCK

- 6-kant
- verchromt
- Chrom-Vanadium

Socket 1/2" SUPERLOCK

- hexagonal
- chromium plated
- Chrom-Vanadium



Bestell-Nr. Order-no.	SW mm Wrench size mm	Bestell-Nr. Order-no.	SW mm Wrench size mm
23-212008-9	8	23-212021-9	21
23-212009-9	9	23-212022-9	22
23-212010-9	10	23-212023-9	23
23-212011-9	11	23-212024-9	24
23-212012-9	12	23-212025-9	25
23-212013-9	13	23-212026-9	26
23-212014-9	14	23-212027-9	27
23-212015-9	15	23-212028-9	28
23-212016-9	16	23-212029-9	29
23-212017-9	17	23-212030-9	30
23-212018-9	18	23-212032-9	32
23-212019-9	19	23-212035-9	35
23-212020-9	20	23-212036-9	36

Schraubendreher-Einsatz XZN 1/2"

- DIN 3120C
- für Vielzahnschrauben
- verchromt
- Chrom-Vanadium

Screwdriver socket XZN 1/2"

- DIN 3120C
- for XZN-screws
- chromium plated
- Chrom-Vanadium



Bestell-Nr. Order-no.	Abmessung mm Size mm	Bestell-Nr. Order-no.	Abmessung mm Size mm
23-214001-0	5 x 52	23-214008-0	10 x 53
23-214002-0	6 x 52	23-214009-0	10 x 100
23-214003-0	6 x 100	23-214011-0	12 x 55
23-214004-0	7 x 100	23-214012-0	12 x 100
23-214005-0	8 x 53	23-214014-0	14 x 58
23-214006-0	8 x 100	23-214015-0	14 x 100
23-214007-0	9 x 100		

Steckschlüssel 1/2" extra-tief

- 6-kant
- verchromt
- Chrom-Vanadium

Socket 1/2" extra deep

- hexagonal
- chromium plated
- Chrom-Vanadium



Bestell-Nr. Order-no.	SW mm Wrench size mm	Bestell-Nr. Order-no.	SW mm Wrench size mm
23-212510-9	10	23-212519-9	19
23-212511-9	11	23-212520-9	20
23-212512-9	12	23-212521-9	21
23-212513-9	13	23-212522-9	22
23-212514-9	14	23-212524-9	24
23-212515-9	15	23-212527-9	27
23-212516-9	16	23-212530-9	30
23-212517-9	17	23-212532-9	32
23-212518-9	18		

Schraubendreher-Einsatz 1/2"

- DIN 3120C
- für Innensechskantschrauben
- verchromt
- Chrom-Vanadium

Screwdriver socket 1/2"

- DIN 3120C
- chromium plated
- Chrom-Vanadium



Bestell-Nr. Order-no.	Abmessung mm Size mm	Bestell-Nr. Order-no.	Abmessung mm Size mm
23-216501-0	5 x 52	23-216511-0	8 x 100
23-216502-0	5 x 100	23-216514-0	10 x 52
23-216504-0	6 x 52	23-216515-0	10 x 100
23-216505-0	6 x 100	23-216517-0	12 x 52
23-216507-0	7 x 52	23-216518-0	12 x 100
23-216508-0	7 x 100	23-216520-0	14 x 52
23-216510-0	8 x 52	23-216521-0	14 x 100

Umsteckratsche 1/2"

- umsteckbar mit 4-kant
- Griff isoliert
- Chrom-Vanadium

Fixable ratchet 1/2"

- with square drive
- insulated handle
- Chrom-Vanadium



Bestell-Nr. Order-no.	Artikel Item	Länge mm Length mm
23-222500-9	Umsteckratsche	250
23-225500-9	Vierkant für Ratsche/square for ratchet	

Hebel-Umschaltratsche 1/2"

- mit Teleskopauszug
- 72 Zähne
- Chrom-Vanadium

Ratchet 1/2"

- with telescopic extension
- 72 teeth
- Chrom-Vanadium



Bestell-Nr. Order-no.	Länge mm Length mm
23-224500-9	330-440

Ratsche 1/2" DIN 3122

- umschaltbar
- mit rutschfestem Griff
- verchromt
- Chrom-Vanadium

Ratchet 1/2" DIN 3122

- reversible
- with anti-slip handle
- chromium plated
- Chrom-Vanadium



Bestell-Nr. Order-no.	Ausführung Execution	Länge mm Length mm
23-223500-9	gerade/straight	250
23-223501-9	ergonomisch/ergonomic	250

Steckschlüsselsatz 1/2" SUPERLOCK

- im Kunststoffkasten
- verchromt
- Chrom-Vanadium

Socket set 1/2" SUPERLOCK

- in case
- chromium plated
- Chrom-Vanadium



Bestell-Nr. Order-no.	Steckschlüssel mm Sockets mm	Stück/Satz Pieces/Set
23-230000-9	8-32	25



Steckschlüssel 1"

- 6-kant
- verchromt
- Chrom-Vanadium

Socket 1"

- hexagonal
- chromium plated
- Chrom-Vanadium



Bestell-Nr. Order-no.	Schlüsselweite mm Wrench size mm
23-241536-9	36
23-241538-9	38
23-241541-9	41
23-241546-9	46
23-241550-9	50
23-241555-9	55
23-241560-9	60
23-241565-9	65
23-241570-9	70
23-241575-9	75
23-241580-9	80

Hebelumschaltratsche 3/4"

- mit Teleskopauszug
- 6 Positionen feststellbar
- 24 Zähne
- Chrom-Vanadium

Reversible Ratchet 3/4"

- with telescopic extension
- 6 positions fixable
- 24 teeth
- Chrom-Vanadium



Bestell-Nr. Order-no.	Länge mm Length mm
23-238000-9	610-1010

Hebelumschaltratsche 1"

- 24 Zähne
- Chrom-Vanadium

Reversible Ratchet 1"

- 24 teeth
- Chrom-Vanadium



Bestell-Nr. Order-no.	Gesamtlänge mm Total length mm
23-245000-9	675

Umsteckratsche 1/2"
DIN 3122/3315

- umsteckbar mit 4-kant
- 24 Zähne
- mit rutschfestem Griff
- verchromt
- Chrom-Vanadium



Fixable ratchet 1/2"
DIN 3122/3315

- with square drive
- 24 teeth
- with anti-slip handle
- chromium plated
- Chrom-Vanadium



Bestell-Nr.
Order-no.

Länge mm
Length mm

23-246000-0

250

Ratsche 1/2"
DIN 3122/3315

- umschaltbar
- 60 Zähne
- mit rutschfestem Griff
- verchromt
- Chrom-Vanadium



Ratchet 1/2"
DIN 3122/3315

- reversible
- 60 teeth
- with anti-slip handle
- chromium plated
- Chrom-Vanadium



Bestell-Nr.
Order-no.

Länge mm
Length mm

23-246100-0

250

Hebelumschaltratsche 1/2"
DIN 3122/3315

- 32 Zähne
- mit rutschfestem Griff
- verchromt
- Chrom-Vanadium



Reversible ratched 1/2"
DIN 3122/3315

- lever type
- 32 teeth
- with anti-slip handle
- chromium plated
- Chrom-Vanadium



Bestell-Nr.
Order-no.

Länge mm
Length mm

23-246200-0

250



Steckschlüsseinsatz 1/2" 12-kant

- nach DIN 3124/ISO2725
- mit Kugelfangrinne
- verchromt
- Chrom-Vanadium

Sockets 1/2" double hexagonal

- according to DIN3124/ISO2725
- with ball retaining groove
- chromium plated
- Chrom-Vanadium



Bestell-Nr. Order-no.	SW mm Wrench size mm	Bestell-Nr. Order-no.	SW mm Wrench size mm
23-246508-0	8	23-246520-0	20
23-246509-0	9	23-246521-0	21
23-246510-0	10	23-246522-0	22
23-246511-0	11	23-246523-0	23
23-246512-0	12	23-246524-0	24
23-246513-0	13	23-246525-0	25
23-246514-0	14	23-246526-0	26
23-246515-0	15	23-246527-0	27
23-246516-0	16	23-246528-0	28
23-246517-0	17	23-246529-0	29
23-246518-0	18	23-246530-0	30
23-246519-0	19	23-246532-0	32

Steckschlüsseinsatz 1/2" 6-kant

- nach DIN 3124/ISO2725
- mit Kugelfangrinne
- verchromt
- Chrom-Vanadium

Sockets 1/2" hexagonal

- acc. to DIN3124/ISO2725
- with ball retaining groove
- chromium plated
- Chrom-Vanadium



Bestell-Nr. Order-no.	SW mm Wrench size mm	Bestell-Nr. Order-no.	SW mm Wrench size mm
23-246608-0	8	23-246621-0	21
23-246609-0	9	23-246622-0	22
23-246610-0	10	23-246623-0	23
23-246611-0	11	23-246624-0	24
23-246612-0	12	23-246625-0	25
23-246613-0	13	23-246626-0	26
23-246614-0	14	23-246627-0	27
23-246615-0	15	23-246628-0	28
23-246616-0	16	23-246629-0	29
23-246617-0	17	23-246630-0	30
23-246618-0	18	23-246632-0	32
23-246619-0	19	23-246633-0	33
23-246620-0	20	23-246634-0	34

Wagenheber

- Flaschenform
- TÜV/GS geprüft



Bottle jack

- TÜV/GS approval

Bestell-Nr. Order-no.	Tragkraft kg Capacity up to kg
23-248020-9	2.000
23-248050-9	5.000
23-248080-9	8.000

Unterstellbock im Satz

- mit 4 Stützbeinen
- 10-stufig höhenverstellbar



Axel stand set

- with 4 supports
- 10 times adjustable in height

Bestell-Nr. Order-no.	Tragkraft kg Capacity up to kg	Stellhöhe mm Variable height mm
23-250002-9	2.000	265 - 418
23-250003-9	3.000	280 - 420
23-250006-9	6.000	382 - 600

Rangierwagenheber

- TÜV/GS geprüft
- mit 4 Rädern
- im Tragekasten



Trolley jack

- TÜV/GS approval
- with 4 wheels
- in carry case



Bestell-Nr. Order-no.	Tragkraft kg Capacity up to kg
23-249020-9	2.000

Werkzeugkoffer aus Stahlblech

- 5-teilig
- mit 1 Tragegriff
- lackiert

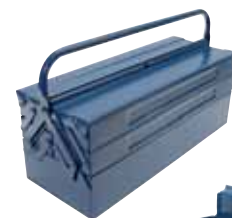

Metal tool box

- with 5 trays
- with only 1 carrying handle

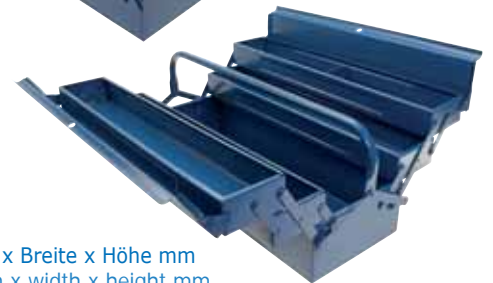

Bestell-Nr. Order-no.	Länge x Breite x Höhe mm Length x width x height mm
23-251043-0	430 x 200 x 200
23-251053-0	530 x 200 x 200

Rangierwagenheber

- TÜV/GS geprüft
- mit 4 Rädern

Trolley jack

- TÜV/GS approval
- with 4 wheels



Bestell-Nr. Order-no.	Tragkraft kg Capacity up to kg
23-249022-9	2.250

Werkzeugkoffer aus Stahlblech

- 5-teilig
- mit 2 Tragegriffen
- lackiert



Metal tool box

- with 5 trays
- with 2 carrying handles

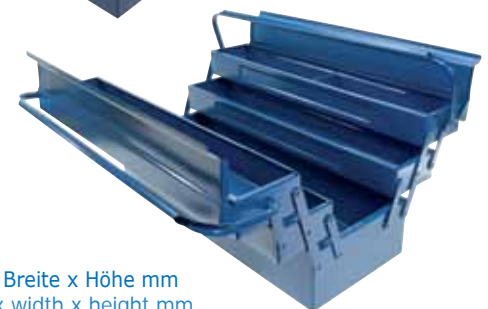

Bestell-Nr. Order-no.	Länge x Breite x Höhe mm Length x width x height mm
23-251143-0	430 x 200 x 200
23-251153-0	530 x 200 x 200

Aluminium-Werkzeugkoffer

verstellbare
Innenfächer

Aluminium tool case

reversible
compartments



Bestell-Nr.
Order-no.

23-252000-9

Länge x Breite x Höhe mm
Length x width x height mm

460 x 340 x 150

Mini-Kompressor

- für 12 Volt Anschluss
- zum Aufpumpen von Bällen, Luftmatrazen, Reifen etc.

Air compressor

- for 12 Volt use
- suitable for inflating balls
mattresses, wheels etc.



Bestell-Nr.
Order-no.

23-255000-9

Arbeitsdruck bar/psi
Working pressure bar/psi

18/250



Kraftstoffkanister

- für Benzin- oder Dieseldieselkraftstoff
- aus Kunststoff
- mit Ausgießer

Fuel jerrycans

- usable for petrol
or diesel
- PE
- with flexible spout



Bestell-Nr.
Order-no.

23-260000-0

Füllmenge Ltr.
Capacity Ltr.

5

Farbe
Colour

schwarz/black

23-260001-0

5

rot/red

23-260100-0

10

schwarz/black

23-260101-0

10

rot/red

23-260200-0

20

schwarz/black

23-260201-0

20

rot/red

Kraftstoffkanister

- aus Metall
- ohne Ausgießer
- sauber lackiert

Fuel jerrycans

- all metal
- without spout
- compatible with military cans



Bestell-Nr.
Order-no.

23-265005-0

Füllmenge Liter
Capacity liter

5

Farbe
Colour

grün

23-265010-0

10

grün

23-265020-0

20

grün

Ausgießer

- flexibel
- für Kraftstoffkanister aus Metall

Flexible spout

- flexible
- for jerrycans made of metal



Bestell-Nr.
Order-no.

23-266000-0



**Schneidwerkzeuge**

Schneidkluppen	124
Handgewindebohrer	124-125
Schneideisen	126

Cutting tools

Stock and dies	124
Hand taps	124-125
Round dies	126

**Anwendungswerkzeuge**

Gewindefeile	125
Verlängerung	126
Werkzeughalter	127-128
Schneideisenhalter	127-129

Applications

Thread repairing file	125
Extension	126
Tap holder	127-128
Die stocks	127-129

**Sätze**

Gewindefeile	129
Gewindebohrersatz	129

Sets

Thread cutting set	129
Hand taps set	129

Rohrgewindeschneidkluppensatz

- Ratschensystem
- 7-teilig
- im Kasten

Set of stock and die

- ratchet system
- set of 7 pieces
- in case



Bestell-Nr. Order-no.	Artikel Item	Abmessung Zoll Size inch
24-100000-9	Satz/Set	1/4 - 3/8 - 1/2 - 3/4 - 1 - 1.1/4
24-101014-9	Ersatzbacke/spare die head	1/4
24-101038-9	Ersatzbacke/spare die head	3/8
24-101012-9	Ersatzbacke/spare die head	1/2
24-101034-9	Ersatzbacke/spare die head	3/4
24-101010-9	Ersatzbacke/spare die head	1
24-101011-9	Ersatzbacke/spare die head	1.1/4

Handgewindebohrersatz DIN 352

- HSS-G
- metrisches ISO Gewinde DIN 13
- Satz bestehend aus Vor-, Mittel- und Fertigschneider
- 3-teilig im Plastikkestchen

Hand tap set DIN 352

- HSS-G
- metric ISO thread DIN 13
- set of 3 pieces
(taper, plug and bottoming)
- in box



Bestell-Nr. Order-no.	Nennmaß specified size
24-115001-9	M 3 x 0,5
24-115002-9	M 3,5 x 0,6
24-115003-9	M 4 x 0,7
24-115004-9	M 4,5 x 0,75
24-115005-9	M 5 x 0,8
24-115006-9	M 6 x 1,0
24-115007-9	M 7 x 1,0
24-115008-9	M 8 x 1,25
24-115009-9	M 9 x 1,25
24-115010-9	M 10 x 1,5
24-115011-9	M 11 x 1,5
24-115012-9	M 12 x 1,75
24-115013-9	M 14 x 2,0
24-115014-9	M 16 x 2,0
24-115015-9	M 18 x 2,5
24-115016-9	M 20 x 2,5
24-115017-9	M 22 x 2,5
24-115018-9	M 24 x 3,0

Handgewindebohrersatz DIN 5157

- HSS-G (BSP)
- Satz bestehend aus Vor- und Fertigschneider
- 2-teilig im Plastikkestchen

Hand tap set DIN 5157

- HSS-G (BSP)
- set of 2 pieces (taper and bottoming)
- in box



Bestell-Nr. Order-no.	Artikel Item	Nennmaß specified size
24-116018-9	Satz/Set	1/8" x 28
24-116014-9	Satz/Set	1/4" x 19
24-116038-9	Satz/Set	3/8" x 19
24-116012-9	Satz/Set	1/2" x 14
24-116034-9	Satz/Set	3/4" x 14
24-116010-9	Satz/Set	1" x 11
24-116118-9	Fertigschneider/bottoming tap	1/8" x 28
24-116114-9	Fertigschneider/bottoming tap	1/4" x 19
24-116138-9	Fertigschneider/bottoming tap	3/8" x 19
24-116112-9	Fertigschneider/bottoming tap	1/2" x 14
24-116134-9	Fertigschneider/bottoming tap	3/4" x 14
24-116110-9	Fertigschneider/bottoming tap	1" x 11

Handgewindebohrersatz DIN 352

- HSS-G (UNC - amerikanisches Grobgewinde)
- Satz bestehend aus Vor-, Mittel- und Fertigschneider
- 3-teilig im Plastikästchen



Hand tap set DIN 352

- HSS-G (UNC - american coarse thread)
- set of 3 pieces (taper, plug and bottoming)
- in box

Bestell-Nr. Order-no.	Nennmaß specified size
24-117501-9	1/4" x 20
24-117502-9	5/16" x 18
24-117503-9	3/8" x 16
24-117504-9	7/16" x 16
24-117505-9	1/2" x 13
24-117506-9	9/16" x 12
24-117507-9	5/8" x 11
24-117508-9	3/4" x 10
24-117509-9	7/8" x 9
24-117510-9	1" x 8
24-117511-9	1.1/8" x 7
24-117512-9	1.1/4" x 7
24-117513-9	1.3/8" x 6
24-117514-9	1,1/2" x 6

Handgewindebohrersatz DIN 2181

- HSS-G (UNF)
- Satz bestehend aus Vor- und Fertigschneider
- 2-teilig im Plastikästchen



Hand tap set DIN 2181

- HSS-G (UNF)
- set of 2 pieces (taper and bottoming)
- in box

Bestell-Nr. Order-no.	Nennmaß specified size
24-117801-9	1/4" x 28
24-117802-9	5/16" x 24
24-117803-9	3/8" x 24
24-117804-9	7/16" x 20
24-117805-9	1/2" x 20
24-117806-9	9/16" x 18
24-117807-9	5/8" x 18
24-117808-9	3/4" x 16
24-117809-9	7/8" x 14
24-117810-9	1" x 12
24-117811-9	1" x 14
24-117812-9	1.1/8" x 12
24-117813-9	1.1/4" x 12
24-117814-9	1.3/8" x 12
24-117815-9	1,1/2" x 12

Universal-Gewindefeile

für die manuelle Nachbearbeitung von Außen- und Innengewinden an technischen Bauteilen wie z.B.

- Schrauben
- Bolzen
- Wellen und Achsen

Universal thread repairing file

for manual finishing of in- and outside threads of

- screws
- bolts
- axles



Bestell-Nr. Order-no.	Abmessung Size
24-118000-0	metrisch M 5 - 27 ISO
24-118500-0	BSW-BSF 24G-10G (3/16-1")
24-119000-0	UNF - UNC 11G - 24 G

Gewindebohrer-Verlängerung DIN 377

- vierkant nach DIN 10

Extension for taps DIN 377

- squares according to DIN 10



Bestell-Nr. Order-no.	Ø mm Ø mm	für Gewindebohrer for taps
24-120001-0	2,1	M 1 - 2,6
24-120002-0	2,4	
24-120003-0	3,7	M 3
24-120004-0	3,0	M 3,5
24-120005-0	3,4	M 4
24-120006-0	3,8	
24-120007-0	4,3	
24-120008-0	4,9	M 5 - 8
24-120009-0	5,5	M 9 - 10
24-120010-0	6,2	M 11
24-120011-0	7,0	M 12
24-120012-0	8,0	
24-120013-0	9,0	M 14 - 16
24-120014-0	10,0	
24-120015-0	11,0	M 18
24-120016-0	12,0	M 20
24-120017-0	13,0	
24-120018-0	14,5	M 22 - 24
24-120019-0	16,0	M 27
24-120020-0	18,0	M 30
24-120021-0	20,0	M 33
24-120022-0	22,0	M 36
24-120023-0	24,0	M 39 - 42
24-120024-0	26,0	

Schneideisen DIN 223/22568

- HSS
- rund
- metrisches ISO Gewinde DIN 13

Round dies DIN 223/22568

- HSS
- round
- metric ISO thread DIN 13



Bestell-Nr. Order-no.	Nennmaß specified size	für Halter for die stocks
24-121003-9	M 3 x 0,5	20 x 5
24-121035-9	M 3,5 x 0,6	20 x 5
24-121004-9	M 4 x 0,7	20 x 5
24-121045-9	M 4,5 x 0,75	20 x 7
24-121005-9	M 5 x 0,8	20 x 7
24-121006-9	M 6 x 1,0	20 x 7
24-121007-9	M 7 x 1,0	25 x 9
24-121008-9	M 8 x 1,25	25 x 9
24-121009-9	M 9 x 1,25	25 x 9
24-121010-9	M 10 x 1,5	30 x 11
24-121011-9	M 11 x 1,5	30 x 11
24-121012-9	M 12 x 1,75	38 x 14
24-121014-9	M 14 x 2,0	38 x 14
24-121016-9	M 16 x 2,0	45 x 18
24-121018-9	M 18 x 2,5	45 x 18
24-121020-9	M 20 x 2,5	45 x 18
24-121022-9	M 22 x 2,5	55 x 22
24-121024-9	M 24 x 3,0	55 x 22



Schneideisenhalter DIN 225/22568

für runde Schneideisen

Die stock DIN 225/22568

for round dies



Bestell-Nr. Order-no.	Ø mm Ø mm
24-125001-9	16 x 5
24-125002-9	20 x 5
24-125003-9	20 x 7
24-125004-9	25 x 9
24-125005-9	30 x 11
24-125006-9	38 x 10
24-125007-9	38 x 14
24-125008-9	45 x 14
24-125009-9	45 x 18
24-125010-9	55 x 16
24-125011-9	55 x 22
24-125012-9	65 x 18
24-125013-9	65 x 25
24-125014-9	75 x 20
24-125015-9	75 x 30

Bestell-Nr. Order-no.	Ø/Zoll Ø/inch
24-126008-9	5/8 x 1/4
24-126009-9	13/16 x 1/4
24-126010-9	1 x 3/8
24-126011-9	1 1/2 x 1/2
24-126013-9	1 3/4 x 9/16
24-126015-9	1 5/16 x 7/16
24-126020-9	2 x 5/8
24-126019-9	2 1/4 x 11/16
24-126021-9	2 1/2 x 3/4

Werkzeughalter PROFI mit Ratsche

- rechts-/links-drehend
- verchromt

Tap holder PROFI with ratchet

- right/left hand use
- chromium plated



Bestell-Nr. Order-no.	für Schneidbereich for cutting cap.	Größe Size
24-127001-0	M 3-10	1
24-127002-0	M 5-12	2

Werkzeughalter mit Ratsche

- rechts-/links-drehend
- verchromt

Tap holder with ratchet

- right/left hand use
- chromium plated



Bestell-Nr. Order-no.	für Schneidbereich for cutting cap.	Größe Size
24-128001-9	M 3-10	1
24-128002-9	M 5-12	2

Werkzeughalter mit Ratsche PROFI

- lange Form
- rechts-/links-drehend
- verchromt

Tap holder with ratchet PROFI

- long type
- right/left hand use
- chromium plated



Bestell-Nr. Order-no.	für Schneidbereich for cutting cap.	Größe Size	Gesamtlänge mm Total length mm
24-129010-0	M 3-10	1	250
24-129020-0	M 5-12	2	300

Ersatzbacken mit Feder

für Werkzeughalter

Spare jaws and spring set

for Tap holder

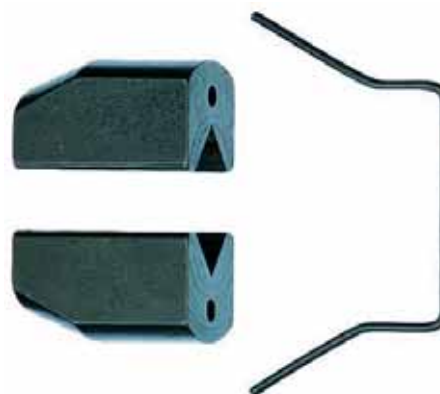

Bestell-Nr. Order-no.	für Größe for size
24-130510-0	1
24-130520-0	2

Werkzeughalter mit Ratsche

- lange Form
- rechts-/links-drehend
- verchromt

Tap holder with ratchet

- long type
- right/left hand use
- chromium plated



Bestell-Nr. Order-no.	für Schneidbereich for cutting cap.	Größe Size	Gesamtlänge mm Total length mm
24-130010-9	M 3-10	1	250
24-130020-9	M 5-12	2	300

Windeisen DIN 1814

- verstellbar
- aus Zinkdruckguß
- gehärtete Backen

Tap wrench DIN 1814

- adjustable
- made of zinc die cast
- hardened jaws



Bestell-Nr. Order-no.	Größe size	für Gewindeschäfte for thread shank
24-132000-9	0	M 1-8
24-132010-9	1	M 1-10
24-132015-9	1.5	M 1-12
24-132020-9	2	M 4-12
24-132030-9	3	M 5-20
24-132040-9	4	M 11-27
24-132050-9	5	M 13-32
24-132060-9	6	M 18-42
24-132070-9	7	M 25-52



Kugelwindeisen

4-kant nach DIN 10

Ball tap wrench

squares according to DIN 10

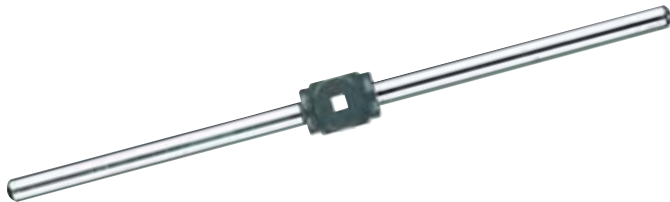

Bestell-Nr. Order-no.	Größe size	für Gewindeschäfte for thread shank
24-133000-9	0	M 1-4
24-133001-9	1	M 3-8
24-133002-9	2	M 4-10
24-133003-9	3	M 5-12
24-133004-9	4	M 10-14
24-133005-9	5	M 12-20

Gewindeschneidsatz

- aus Wolfram-legiertem Spezialstahl
- rechts
- in Metallkassette

Thread cutting set

- made of Wolfram special steel
- right
- in metal case



Bestell-Nr. Order-no.	für Schneidbereich for cutting cap.	Teile Pieces
24-137500-9	M 3-12	40

Gewindeschneidsatz PROFI DIN 325/223

- HSS-G
- rechts
- in Metallkassette

Thread cutting set PROFI DIN 352/223

- HSS-G
- right
- in metal case



Bestell-Nr. Order-no.	für Schneidbereich for cutting cap.	Satz teilig Pieces/Set
24-137000-9	M 3-12	44

Handgewindebohrersatz DIN 352

Satz bestehend aus Vor-, Mittel- und Fertigschneider, jeweils 3 Stück pro Abmessung

- HSS-G
- in Metallkassette

Hand taps set DIN 352

each size of 3 pieces (taper, plug and bottoming)

- HSS-G
- in metal box



Bestell-Nr. Order-no.	für Schneidbereich for cutting cap.	Teile Pieces
24-138000-9	M 3-12	21



**Längenmessung**

Bandmaße	132-133
Streichmaß	137
Lineale	140
Stahlmaßstäbe	140-141

Lengthmeasuring

Measuring tapes	132-133
Marking gauge	137
Rulers	140
Steel rulers	140-141

**Winkel-/
Gradmessung**

Schlosserwinkel	134
Flanschenwinkel	134
Schreiner-/ Zimmermannswinkel	134-136
Schmiegenwinkel	135
Gradmesser	137
Senklote	138
Wasserwaagen	138-139

**Angle/degree
measuring**

Mechanic's square	134
Flange square	134
Carpenter's square	134-136
Sliding bevel	135
Protractor	137
Plumb bob	138
Spirit level	138-139

**Durchmesser/
Umfang**

Zirkel	141-142
Umfangbandmaß	149

**Diameter/
circumference**

Dividers	141-142
Circumference rule	149

**Stärke/Abstand**

Schieblehren	143-145
Knopfmaß	145
Profiltiefenmaß	145
Fühlerlehren	146-147
Gewinde-/Radienschablone	147
Fühlerlehrenband	148
Mikrometer	149
Düsenlehren	149

Strength/distance

Calipers	143-145
Button gauge	145
Tyre profile depth gauge	145
Feeler gauges	146-147
Screw pitch-/radius gauge	147
Feeler gauge tape	148
Mikrometer	149
Jet gange	149

**Zubehör**

Zimmermannsbleistift	136-137
Reissnadeln	142-143

Accessories

Carpenter's pencils	136-137
Steel scribers	142-143

Rollbandmaß mit Schnellstopptaste

- mit Gürtelklipp
- automatischer Rücklauf und Doppelstopp
- ABS-Gehäuse
- Gleitendhaken mit zwei Nieten
- Klasse II nach EG-Norm

Measuring tape with quick stop

- with belt clip
- automatic return and double stop
- ABS case
- hook with two rivets
- class II/CE



Bestell-Nr. Order-no.	Länge m Length m	Breite mm Width mm
25-120002-9	2	13
25-120003-9	3	16
25-120005-9	5	19
25-120008-9	8	25
25-120010-9	10	25

Rollbandmaß Selbststopp

- mit Gummischutz
- mit Gürtelklipp
- ABS-Gehäuse
- Gleitendhaken mit zwei Magneten
- Klasse II nach EG-Norm
- im Verkaufskarton zu 12 Stück

Measuring tape Selflock

- with rubber protection
- with belt clip
- ABS case
- hook with two magnets
- class II/CE
- 12 pieces in display



Bestell-Nr. Order-no.	Länge m Length m	Breite mm Width mm
25-123005-9	5	19

Rollbandmaß Selbststopp

- mit Gummischutz
- mit Gürtelklipp
- ABS-Gehäuse
- Gleitendhaken mit zwei Magneten
- Klasse II nach EG-Norm
- auf SB-Karte

Measuring tape Selflock

- with rubber protection
- with belt clip
- ABS case
- hook with two magnets
- class II/CE
- on card



Bestell-Nr. Order-no.	Länge m Length m	Breite mm Width mm
25-121003-9	3	16
25-121005-9	5	19
25-121008-9	8	25

Rollbandmaß mit Karabiner

- Klasse II nach EG-Norm

Measuring tape with snap hook

- class II/CE



Bestell-Nr. Order-no.	Länge m Length m	Breite mm Width mm
25-123505-9	5	19
25-123508-9	8	25

Glasfaserbandmaß

- in Platakapsel
- cm/cm oder cm/Zoll
- Maß beidseitig
- Bandbreite 13 mm

Fiberglass measuring tape

- in PVC coated steel case
- cm/cm or cm/inch
- measuring on both sides
- width 13 mm



Bestell-Nr. Order-no.	Länge m Length m	Start Start
25-124020-0	20	C
25-124030-0	30	C
25-124050-0	50	C

Stahl-Rollbandmaß PRIMA

- mit schlagfestem PVC-Heft
- mit Drehkurbel
- Maß einseitig
- mit Starthaken
- Klasse II nach EG-Norm

Steel measuring tape PRIMA

- one side with graduation
- class II/CE
- with hook



Bestell-Nr. Order-no.	Länge m Length m	Breite mm Width mm	Ausführung
25-130030-9	30	13	mit Pistolengriff
25-130050-9	50	13	mit offenem Alu-Rahmen

Fiberglas-Rollbandmaß PRIMA

- Maßeinteilung beidseitig
- mit Starthaken
- metrische Maßeinteilung
- Klasse III nach EG-Norm

Fiberglass tape PRIMA

- metric graduation on 2 sides
- with hook
- class III/CE



Bestell-Nr. Order-no.	Länge m Length m
25-128020-9	20
25-128030-9	30
25-128050-9	50

Fiberglas-Bandmaß PRIMA

- Maß beidseitig
- mit offenem Kunststoff Rahmen
- mit Starthaken
- metrische Teilung
- Klasse III nach EG-Norm

Fiberglass measuring tape

- with graduation on both sides
- with open PVC case
- with start hook
- metric measuring
- class III/CE



Bestell-Nr. Order-no.	Länge m Length m	Breite mm Width mm
25-131050-9	50	13

Schlosserwinkel

- rostgeschützt
- verzinkt
- Standard Qualität



Mechanic's square

- rust resistant
- zinc plated
- standard quality

Bestell-Nr. Order-no.	Abmessung mm Size mm
25-135001-0	100 x 70
25-135015-0	150 x 100
25-135020-0	200 x 130
25-135025-0	250 x 160
25-135030-0	300 x 180
25-135040-0	400 x 230
25-135050-0	500 x 280
25-135060-0	600 x 330
25-135070-0	700 x 380
25-135080-0	800 x 430
25-135010-0	1.000 x 500

Anschlagwinkel

- rostgeschützt
- verzinkt
- Standard Qualität



Mechanic's square with bevel

- rust resistant
- zinc plated
- standard quality

Bestell-Nr. Order-no.	Abmessung mm Size mm
25-136001-0	100 x 70
25-136015-0	150 x 100
25-136020-0	200 x 130
25-136025-0	250 x 160
25-136030-0	300 x 180
25-136040-0	400 x 230
25-136050-0	500 x 280
25-136060-0	600 x 330
25-136070-0	700 x 380
25-136075-0	750 x 380
25-136080-0	800 x 430
25-136010-0	1.000 x 500

Flanschenwinkel

- rostgeschützt
- verzinkt



Flange square

- rust resistant
- zinc plated

Bestell-Nr. Order-no.	Abmessung mm Size mm
25-137030-0	300 x 300
25-137040-0	400 x 400
25-137050-0	500 x 500
25-137060-0	600 x 600

Aluminium-Schreinerwinkel

beidseitige Maßeinteilung metrisch

Aluminium carpenter's square

metric graduation on both sides

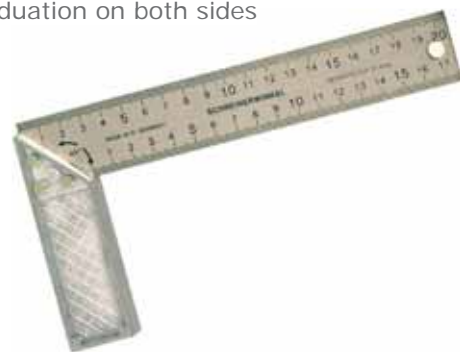

Bestell-Nr. Order-no.	Abmessung mm Size mm
25-138020-0	200
25-138025-0	250
25-138030-0	300
25-138035-0	350
25-138040-0	400



Aluminium-Schreinerwinkel

- beidseitige Maßeinteilung metrisch
- schwere Ausführung

Aluminium carpenter's square

- metric graduation on both sides
- heavy execution



Bestell-Nr. Order-no.	Abmessung mm Size mm
25-139025-9	250
25-139030-9	300
25-139035-9	350
25-139040-9	400

Schmiegenwinkel

- verstellbar
- mit Flügelmutter

Adjustable sliding bevel

- with wing nut
- steel plate



Bestell-Nr. Order-no.	Abmessung mm Size mm
25-141020-0	200
25-141025-0	250
25-141030-0	300



Zimmermannswinkel

- poliert
- chromatisiert
- ohne Masseinteilung
- ohne Anreisslöcher

Carpenter's square

- polished
- chromatisized
- without graduation

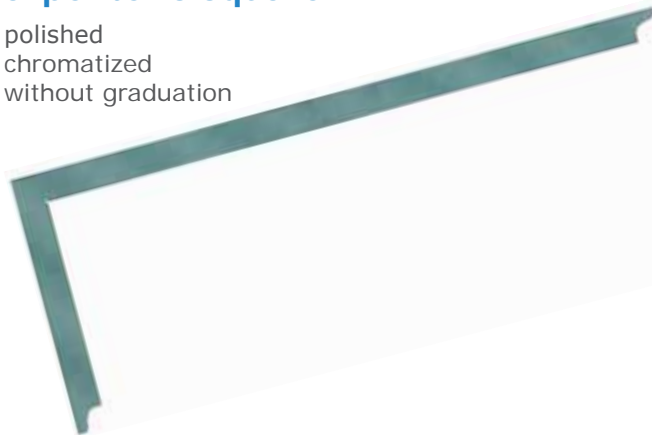

Bestell-Nr. Order-no.	Abmessung mm Size mm
25-143050-0	500 x 260
25-143060-0	600 x 280
25-143070-0	700 x 300
25-143080-0	800 x 320
25-143010-0	1.000 x 380

Zimmermannsbleistift

- oval
- Schrift schwarz
- 12 Stück im Satz

Carpenter's pencil

- oval
- black lead
- set of 12 pieces



Bestell-Nr. Order-no.	Länge mm Length mm
25-145018-9	180

Zimmermannsbleistift

- oval
- Schrift schwarz
- rot lackiert

Carpenter's pencil

- oval
- black lead
- red body



Bestell-Nr. Order-no.	Länge mm Length mm	Stück je Karton pcs. each box
25-145118-9	180	100
25-145125-9	250	100

Zimmermannswinkel

- gelb lackiert
- mit Maßeinteilung

Carpenter's square

- yellow coated
- with graduation

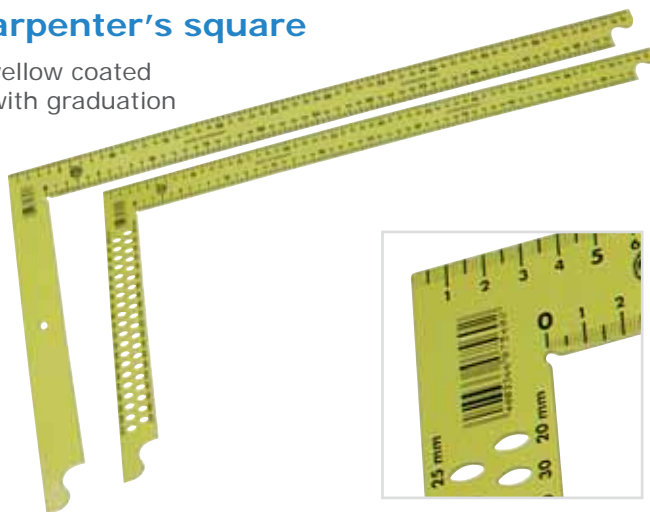

Bestell-Nr. Order-no.	Abmessung mm Size mm	Anreisslöcher Marking holes
25-144060-0	600 x 280	ja/yes
25-144070-0	700 x 300	ja/yes
25-144080-0	800 x 320	ja/yes
25-144010-0	1.000 x 380	ja/yes
25-144560-0	600 x 280	nein/no
25-144570-0	700 x 300	nein/no
25-144580-0	800 x 320	nein/no
25-144510-0	1.000 x 380	nein/no

Zimmermannsbleistifthalter

aus Metall

Carpenter's pencil holder

made of metal



Bestell-Nr. Order-no.	Länge mm Length mm
25-145500-0	200

Zimmermannsbleistifthalter

- aus Metall
- 200 mm Länge

Carpenter's pencil holder

- made of metal
- length 200 mm



Bestell-Nr.
Order-no.

25-145501-0

25-145503-0

Bleistift/Satz
Pencil/Set

1

3

Gradmesser 0-180°

- mit Feststellschraube
- mit Maßeinteilung
- polierte Ausführung

Protractor 0-180°

- with locking screw
- with graduation
- all fine polished



Bestell-Nr.
Order-no.

25-148008-0

25-148012-0

25-148015-0

25-148020-0

25-148025-0

25-148030-0

Abmessung mm
Size mm

80 x 120

120 x 150

150 x 200

200 x 300

250 x 500

300 x 600

Präzisions-Streichmaß

- mit Schieber und Feststeller
- Teilung metrisch

Precision marking gauge

- with slide feed
- locking screw and metric graduation



Bestell-Nr.
Order-no.

25-147020-9

25-147025-9

25-147030-9

Messbereich mm
Measuring mm

200

250

300

INOX-Gradmesser 0-180°

- mit Feststellschraube
- mit Maßeinteilung

INOX Protractor 0-180°

- with locking screw
- with graduation



Bestell-Nr.
Order-no.

25-148008-9

25-148012-9

25-148015-9

25-148020-9

25-148025-9

25-148030-9

Abmessung mm
Size mm

80 x 120

120 x 150

150 x 200

200 x 300

250 x 500

300 x 600

Senklot

- aus Zink-Druckguss
- blank gedreht
- Messingkopf abschraubbar

Plumb Bob

- of zinc die-casting
- bright turned
- with screwable knob of brass



Bestell-Nr. Order-no.	Gewicht g Weight g
25-151030-0	300
25-151040-0	400
25-151050-0	500

Senklot mit Stahlplatte

- aus Zink-Druckguss
- blank gedreht
- Messingkopf abschraubbar

Plumb Bob with steel plate

- of zinc die-casting
- bright turned
- with screwable knob of brass

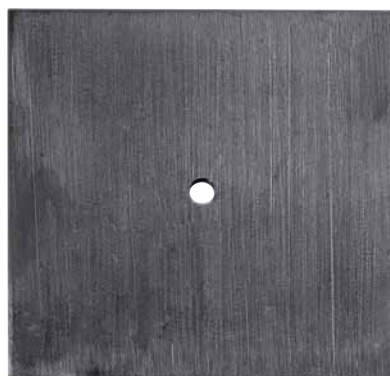

Bestell-Nr. Order-no.	Gewicht g Weight g
25-151530-0	300
25-151540-0	400
25-151550-0	500

Wasserwaage TORPEDO

magnetisch

Level TORPEDO

magnetic



Bestell-Nr. Order-no.	Länge mm Length mm
25-158022-9	225

Aluminium Wasserwaage

- mit zwei Libellen
- horizontal
- vertikal 90°
- silbereloxiert

Aluminium spirit level

- with two vials
- horizontal
- vertical 90°
- silver anodized



Bestell-Nr. Order-no.	Länge mm Length mm
25-160030-0	300
25-160040-0	400
25-160050-0	500
25-160060-0	600
25-160080-0	800
25-160010-0	1.000
25-160012-0	1.200
25-160015-0	1.500
25-160018-0	1.800
25-160020-0	2.000



Aluminium Wasserwaage

- mit drei Libellen
- horizontal
- vertikal 45° und 90°
- silbereloxiert

Aluminium spirit level

- with three vials
- horizontal
- vertical 45° and 90 °
- silver anodized



Bestell-Nr. Order-no.	Länge mm Length mm
25-160530-0	300
25-160540-0	400
25-160550-0	500
25-160560-0	600
25-160580-0	800
25-160510-0	1.000
25-160512-0	1.200
25-160515-0	1.500
25-160518-0	1.800
25-160520-0	2.000

Aluminium Wasserwaage MAGNET

- mit drei Libellen
- horizontal
- vertikal 45° und 90°
- silbereloxiert
- mit zwei Magneten

Aluminium spirit level MAGNET

- with three vials
- horizontal
- vertical 45° and 90 °
- silver anodized
- with two magnets



Bestell-Nr. Order-no.	Länge mm Length mm
25-161040-9	400
25-161060-9	600
25-161080-9	800
25-161010-9	1.000

Stahllineal

- mit oder ohne Fase
- rostgeschützt

Steel rule

- with or without bevel
- rust resistant

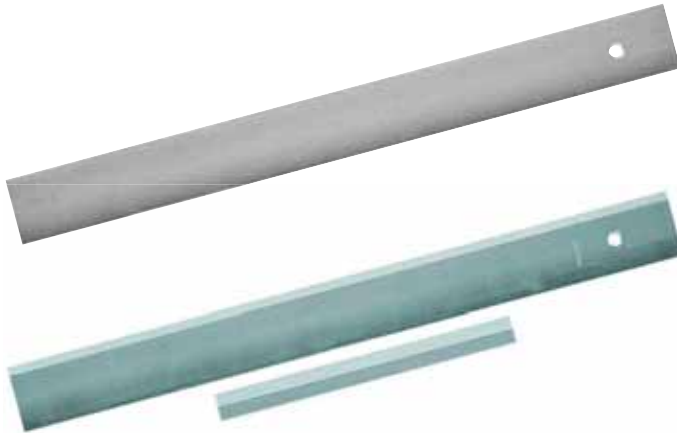

Bestell-Nr. Order-no.	Abmessung mm Size mm	Ausführung Execution
25-162040-0	400	ohne Fase/without bevel
25-162050-0	500	ohne Fase/without bevel
25-162060-0	600	ohne Fase/without bevel
25-162080-0	800	ohne Fase/without bevel
25-162010-0	1.000	ohne Fase/without bevel
25-163040-0	400	mit Fase/with bevel
25-163050-0	500	mit Fase/with bevel
25-163060-0	600	mit Fase/with bevel
25-163080-0	800	mit Fase/with bevel
25-163010-0	1.000	mit Fase/with bevel
25-163015-0	1.500	mit Fase/with bevel
25-163020-0	2.000	mit Fase/with bevel



Aluminium Lineal

- mit Handgriff und metrischer Maßeinteilung
- mit zwei Libellen

Aluminium rule

- with handle and metric graduation
- with two vials



Bestell-Nr. Order-no.	Länge x Breite mm Length x width mm
25-164050-9	500 x 60

Stahlmaßstab

- rostfreier Federbandstahl
- nach EG -Klasse II
- Maß einseitig mm/Zoll
- starre Ausführung (breiter Querschnitt)

Stainless Steel Rule

- according to EC-class II
- with graduation on 1 side mm/inch
- rigid version (wide base)



Bestell-Nr. Order-no.	Länge x Breite x Stärke mm Length x width x thickness mm
25-165030-0	300 x 30 x 1,0
25-165050-0	500 x 30 x 1,0
25-165100-0	1.000 x 30 x 1,0
25-165150-0	1.500 x 30 x 1,0
25-165200-0	2.000 x 30 x 1,0

Stahlmaßstab

- rostfreier Federbandstahl
- gem. DIN ISO 2768 m oder EGII
- Maß einseitig mm/Zoll
- biegsame Ausführung

Stainless Steel Rule

- according to DIN ISO 2768 m or EC II
- with graduation on 1 side mm/inch
- flexible version



Bestell-Nr. Order-no.	Länge x Breite x Stärke mm Length x width x thickness mm
25-166030-0	300 x 18 x 0,5
25-166050-0	500 x 18 x 0,5
25-166100-0	1.000 x 18 x 0,5
25-166150-0	1.500 x 18 x 0,5
25-166200-0	2.000 x 18 x 0,5

Spitzzirkel ohne Bogen

- fein poliert

Divider without wing

- all polished



Bestell-Nr. Order-no.	Länge mm Length mm
25-168515-0	150
25-168520-0	200
25-168525-0	250
25-168530-0	300
25-168540-0	400

Bogenzirkel

- mit Bleistifthalter
- fein poliert

Divider with pencil holder

- all polished

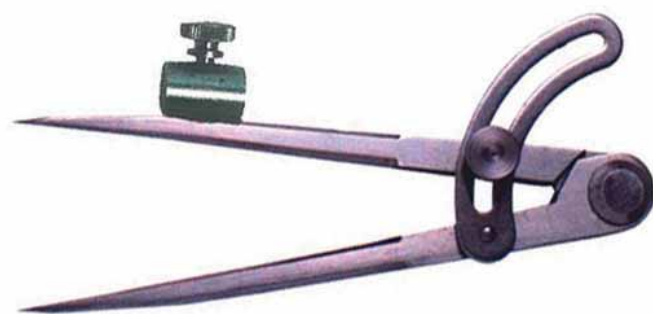

Bestell-Nr. Order-no.	Länge mm Length mm
25-168015-0	150
25-168017-0	175
25-168020-0	200

Spitzzirkel mit Bogen

- fein poliert

Divider with wing

- all polished



Bestell-Nr. Order-no.	Länge mm Length mm
25-169015-0	150
25-169020-0	200
25-169025-0	250
25-169030-0	300
25-169040-0	400

Präzisions-Spitzzirkel

- mit Schnellverstellung
- poliert

Spring divider

- with quick adjustment
- all polished



Bestell-Nr. Order-no.	Länge mm Length mm
25-171015-0	150
25-171017-0	175
25-171020-0	200
25-171025-0	250
25-171030-0	300
25-171040-0	400

Präzisions-Innentaster

- mit Schnellverstellung
- poliert

Inside divider

- with quick adjustment
- all polished

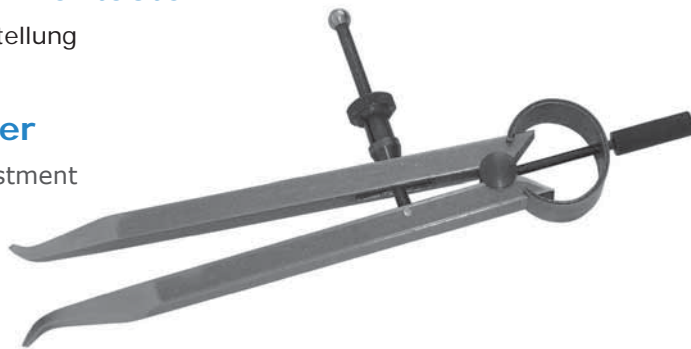

Bestell-Nr. Order-no.	Länge mm Length mm
25-172015-0	150
25-172017-0	175
25-172020-0	200
25-172025-0	250
25-172030-0	300
25-172040-0	400

Präzisions-Außentaster

- mit Schnellverstellung
- poliert

Outside divider

- with quick adjustment
- all polished



Bestell-Nr. Order-no.	Länge mm Length mm
25-173015-0	150
25-173017-0	175
25-173020-0	200
25-173025-0	250
25-173030-0	300
25-173040-0	400

HM-Reißnadel

- Kugelschreiberform
- Spitze einziehbar
- in Tasche

HM-steelscriber

- stylo type
- point retractable
- in wallet



Bestell-Nr. Order-no.	Länge mm Length mm
25-176014-9	145
25-176514-9	145 Ersatz-Reißnadel/spare needle



HM-Reißnadel

- mit Klipp
- verzinkt

HM-steel scriber

- with clip
- zinc plated



Bestell-Nr. Order-no.	Länge mm Length mm	Tasche wallet
25-177015-0	150	ohne/without
25-177515-0	150	mit/with

Reißnadel

- gerade/gebogen
- Griff schwarz oder verzinkt

Steel scriber

- straight/bent
- handle black or zinc plated



Bestell-Nr. Order-no.	Länge mm Length mm
25-178025-9	250

Präzisions-Schieblehre

- rostfrei
- mit Momentfeststeller
- metrisch und inches
- Ablesung 0,05 mm und 1/128"
- in Tasche

Precision caliper

- with self lock
- stainless steel
- metric and inches
- reading 0,05 mm and 1/128"
- in wallet



Bestell-Nr. Order-no.	Messbereich mm Measuring area mm
25-180015-9	150

Präzisions-Schieblehre

- rostfrei
- mit Momentfeststeller
- metrisch und inches
- Ablesung 0,05 mm und 1/128"
- hochwertige Ausführung
- in Tasche

Precision caliper

- with self lock
- stainless steel
- metric and inches
- reading 0,05 mm and 1/128"
- high quality execution
- in wallet



Bestell-Nr. Order-no.	Messbereich mm Measuring area mm
25-180115-9	150
25-180120-9	200



Präzisions-Schieblehre

- rostfrei
- mit Feststellschraube
- metrisch und inches
- Ablesung 0,05 mm und 1/128"
- in Tasche

Precision caliper

- with locking screw
- stainless steel
- metric and inches
- reading 0,05 mm and 1/128"
- in wallet



Bestell-Nr. Order-no.	Messbereich mm Measuring area mm
25-181015-9	150
25-181020-9	200

Präzisions-Uhren-Schieblehre

- mit Feststellschraube
- rostfreier Stahl
- stoßgeschützt
- Ablesung 0,01 mm
- in Kasette

Precision dial caliper

- with adjusting screw
- stainless steel
- shock proof dial
- reading 0,01 mm
- in case



Bestell-Nr. Order-no.	Messbereich mm
25-185015-9	150
25-185020-9	200

Taschen-Schieblehre COLUMBUS

- vernickelt
- 1/10 Nonius
- Feinstellrolle
- mit Kreuzspitzen und Tiefenmaß

pocket slide caliper COLUMBUS

- nickel plated
- 1/10 nonius
- with vernier
- with cross tips and deep gauge

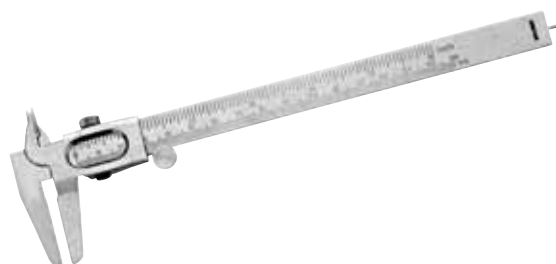

Bestell-Nr. Order-no.	Messbereich mm Measuring area mm
25-182012-9	120

Präzisions-Digital-Schieblehre

- nach DIN 862
- rostfreier Stahl
- umschaltbar mm/Zoll
- LCD-Anzeige, Ablesung 0,01 mm/0,0005"
- mit Feststellschraube
- in Kasette

Precision digital pocket caliper

- according to DIN 862
- stainless steel
- switchable mm/inch
- LCD reading 0,01 mm/0,0005"
- with fixing screw
- in case



Bestell-Nr. Order-no.	Messbereich mm Measuring area mm
25-186015-9	150
25-186020-9	200

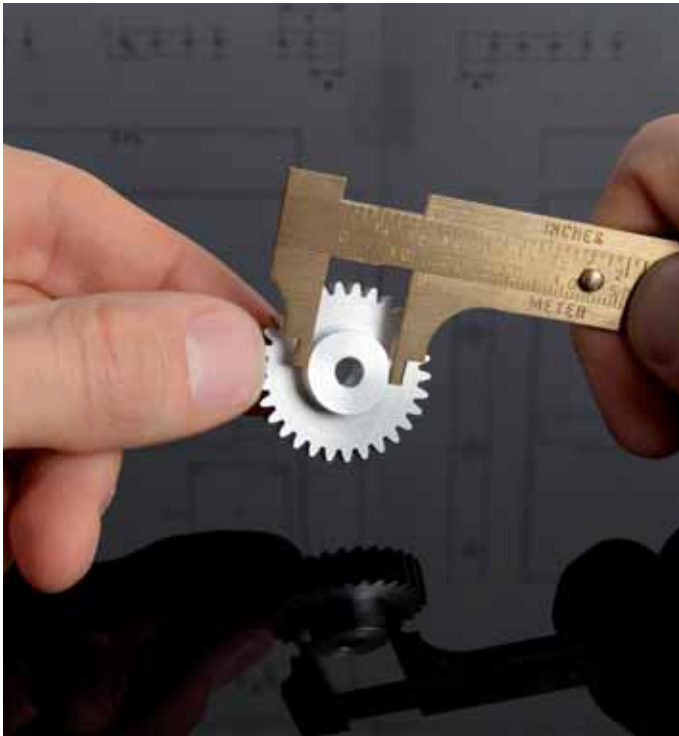

Messing-Knopfmaß

- für Außen- und Innenmessungen
- mit Maßeinteilung

Button gauge

- all brass
- with scale
- measuring outside and inside



Bestell-Nr.
Order-no.
25-191010-0

Messbereich mm
Measuring area mm
100

Präzisions-Digital-Schieblehre

- nach DIN 862
- rostfreier Stahl
- ganz aus Metall
- umschaltbar mm/inch
- LCD-Anzeige, Ablesung 0,01 mm/0,0005"
- in Kassette

Precision digital pocket caliper

- according to DIN 862
- stainless steel
- made of all metal
- switchable mm/inch
- LCD reading 0,01 mm/0,0005"
- in case



Bestell-Nr.
Order-no.
25-187015-9
25-187020-9

Messbereich mm
Measuring area mm
150
200

Reifenprofiliefenmaß

- ganz aus Messing
- mit Nonius-Ablesung

Tyre profile depth gauge

- all brass
- with nonius-reading



Bestell-Nr.
Order-no.
25-191510-0
25-191511-0

Messbereich mm
Measuring area mm
30
50



Fühlerlehre

- polierte Ausführung
- im Scheidenetui

Feeler gauge

- polished
- in sheath



Bestell-Nr. Order-no.	Blattanzahl Blades	Länge mm Length mm	Messbereich Measuring area
25-194008-0	8	100	0,05-0,50 mm
25-195008-0	8	100	2-20/1.000"
25-197013-0	13	100	0,05-1,00 mm
25-197015-0	13	150	0,05-1,00 mm
25-198013-0	13	100	2-35/1.000"
25-199020-0	20	100	0,05-1,00 mm
25-200020-0	20	100	2-40/1.000"
25-201022-0	22	100	0,03-1,00 mm
25-202022-0	22	100	4-25/1.000"
25-203026-0	26	100	0,03-1,00 mm
25-203126-0	26	150	0,03-1,00 mm
25-204026-0	26	100	1.½-25/1.000"
25-204126-0	26	100	0,03-1,00 mm/ 0,001-0,040"
25-205032-0	32	100	0,03-1,00 mm

Fühlerlehre am Ring

- polierte Ausführung

Feeler gauge on ring

- polished



Bestell-Nr. Order-no.	Blattanzahl Blades	Länge mm Length mm	Messbereich Measuring area
25-197115-0	13	150	0,05-1,00 mm
25-197120-0	13	200	0,05-1,00 mm
25-197125-0	13	250	0,05-1,00 mm
25-197130-0	13	300	0,05-1,00 mm
25-197140-0	13	400	0,05-1,00 mm
25-197150-0	13	500	0,05-1,00 mm
25-199115-0	20	150	0,05-1,00 mm
25-199120-0	20	200	0,05-1,00 mm
25-199125-0	20	250	0,05-1,00 mm
25-199130-0	20	300	0,05-1,00 mm
25-199140-0	20	400	0,05-1,00 mm
25-199150-0	20	500	0,05-1,00 mm



Fühlerlehre aus Messing

- polierte Ausführung
- im Scheidenetui

Feeler gauge all brass

- polished
- in sheath

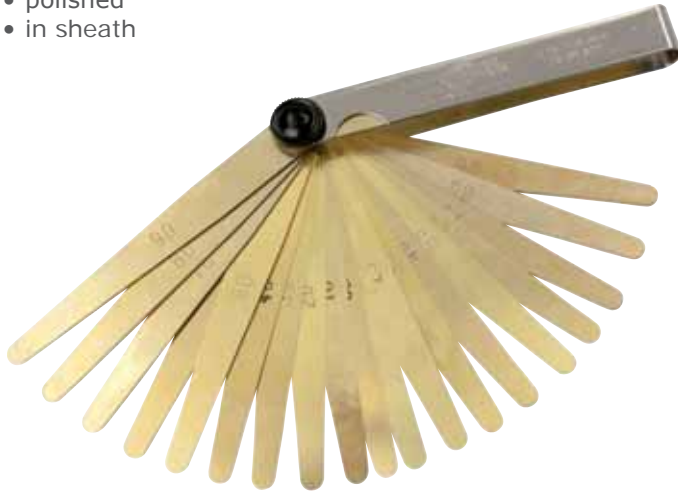

Bestell-Nr. Order-no.	Blattanzahl Blades	Länge mm Length mm	Messbereich Measuring area
25-200120-0	20	100	0,05-1,00 mm

Radienschablonen-Satz

- polierte Ausführung

Radius gauge set

- polished



Bestell-Nr. Order-no.	Messbereich mm Measuring area mm	Blattanzahl blades
25-210010-0	1,0-7	17
25-210007-0	7,5-15	16
25-210015-0	15,5-25	15

Gewindeschablonen-Satz

- polierte Ausführung
- im Scheidenetui

Screw pitch gauge set

- polished
- in sheath



Bestell-Nr. Order-no.	Gewinde threads	Blattanzahl blades
25-207006-0	WW-R 1/8-2.1/2"	6
25-207552-0	MM + WW	52
25-208058-0	MM + WW + WW-R	58
25-209048-0	0,4-7 + WW 1/16-2.1/2"	48

Universal-Gewindestahllehre

Universal thread gauge



Bestell-Nr. Order-no.	Messbereich mm Measuring area mm
25-214000-0	45-70°/2,0-8,0

Trapez-Gewindestahllehre

Trapez thread gauge



Bestell-Nr. Order-no.	Messbereich mm Measuring area mm
25-215000-0	2-12

Fühlerlehrenband

- Bandlänge 5 m
- Bandbreite 13 mm
- in Dose

Feeler gauge tape

- length of 5 m
- width 13 mm
- in box



Bestell-Nr. Order-no.	Stärke mm Thickness mm	Bestell-Nr. Order-no.	Stärke mm Thickness mm
25-220001-0	0,01	25-220025-0	0,25
25-220002-0	0,02	25-220030-0	0,30
25-220003-0	0,03	25-220035-0	0,35
25-220004-0	0,04	25-220040-0	0,40
25-220005-0	0,05	25-220045-0	0,45
25-220006-0	0,06	25-220050-0	0,50
25-220007-0	0,07	25-220060-0	0,60
25-220008-0	0,08	25-220070-0	0,70
25-220009-0	0,09	25-220075-0	0,75
25-220010-0	0,10	25-220080-0	0,80
25-220015-0	0,15	25-220090-0	0,90
25-220020-0	0,20	25-220000-0	1,00

Halter für Fühlerlehrenband

Holder for feeler gauge tape



Bestell-Nr. Order-no.	Länge mm Length mm
25-221012-0	120



Werkstatt-Mikrometer

- mit Schraube
- im Kasten

Workshop micrometer

- with screw
- in box



Bestell-Nr.
Order-no.
25-222025-9

Messbereich mm
Measuring area mm
0-25

Düsenlehre im Halter

vernickelt

Jet gauge in holder

nickel plated



Bestell-Nr. Order-no.	Messbereich mm Measuring area mm	Blattanzahl Blatt
25-223020-0	0,45-1,50	20
25-223016-0	1,50-3,00	16

Umfangbandmaß PIMETER

zum Messen des Umfanges und Durchmessers

- metrische Teilung

circumference rule PIMETER

for measuring of volume and diameter

- metric graduation



Bestell-Nr. Order-no.	Umfang mm Volume mm	Ø mm Ø mm
25-300020-9	60- 950	20- 300
25-300030-9	940-2.200	300- 700
25-300070-9	2.190-3.460	700-1.100
25-300034-9	3.450-4.720	1.100-1.500





Sägen/Sägearbeiten

Handsägen	153-158,160-162, 165
Sägeblätter	161-163, 166-167, 169
Laubsägearbeiten	162-165
Kreissägeblätter	170-172

Saws/Fret working

Hand saws	153-158,160-162, 165
Saw blades	161-163, 166-167, 169
Fret working	162-165
Circular saw blades	170-172



Metzgereibedarf

Knochensäge	157
Wetzstähle	159-160
Fleischhaken	160

Butcher's demand

Butcher's saw	157
Butcher's steels	159-160
Butcher's hooks	160



Feilen

Sägenfeilen	173
Werkstattfeilen	173-177
Raspeln	174, 178-179
Feilensätze	173, 175
Kontaktfeile	175
Feilenhefte	175

Files

Saw files	173
Machinist's files	173-177
Rasps	174, 178-179
File sets	173, 175
Contact files	175
File handles	175



Bearbeitungswerkzeuge

Vorstechahle	152
Schneidladen	156-157
Dübelzieher	157
Streichmaß	167
Holzbeitel	168
Schleifsteine	169
Beile/Äxte	180

Applications

Piercers	152
Mitre boxes	156-157
Dowel extractor	157
Marking gauge	167
Wood chisels	168
Grinding stones	169
Hatchet/Axes	180

Rundahle

- Klinge vernickelt
- mit birnenförmigem Holzheft

Piercer

- round
- blade nickel plated
- with wooden handle



Bestell-Nr. Order-no.	Klingenlänge mm Blade length mm	Klinge Ø mm Blade Ø mm
26-100025-0	65	2,5

Vierkantahle

- Klinge vernickelt
- mit Kraftheft

Piercer

- square
- blade nickel plated
- with plastic handle



Bestell-Nr. Order-no.	Klingenlänge mm Blade length mm	Klinge Ø mm Blade Ø mm
26-102010-0	100	6,0

Rundahle

- Klinge vernickelt
- mit Kraftheft

Piercer

- round
- blade nickel plated
- with plastic handle



Bestell-Nr. Order-no.	Klingenlänge mm Blade length mm	Klinge Ø mm Blade Ø mm
26-100525-0	65	2,5



Rundahle

- Klinge vernickelt
- mit Kraftheft

Piercer

- round
- blade nickel plated
- with plastic handle



Bestell-Nr. Order-no.	Klingenlänge mm Blade length mm	Klinge Ø mm Blade Ø mm
26-101006-0	60	4,0
26-101008-0	80	4,0
26-101010-0	100	6,0

Türkische Handsäge

mit Holzheft

Turkish hand saw

with wooden handle



Bestell-Nr. Order-no.	Blattlänge mm Blade length mm	Zahnung Toothing
26-105030-0	300	normal/normal
26-105035-0	350	normal/normal
26-105530-0	300	fein/fine
26-105535-0	350	fein/fine

Stichsäge

- mit Standardzahnung
- gerade
- geschärft
- mit offenem Holzheft

Compass saw

- normal toothing
- straight
- sharpened
- with wooden handle



Bestell-Nr. Order-no.	Blattlänge mm Blade length mm
26-110025-0	250
26-110030-0	300
26-110035-0	350

Türkische Stichsäge

- normale Zahnung
- mit Holzheft

Turkish compass saw

- normal toothing
- wooden handle



Bestell-Nr. Order-no.	Blattlänge mm Blade length mm
26-107030-0	300
26-107035-0	350

Bagdad Sägen

- mit Holz-Pistolenheft
- Zahnung auf Zug
- maschinenscharf geschränkt

Baghdad saw

- with wooden pistol grip
- set and sharpened



Bestell-Nr. Order-no.	Blattlänge mm Blade length mm
26-111040-0	400
26-111045-0	450

Rebensäge

mit Pistolengriff aus Holz

Pruning saw

with curved wooden pistole handle



Bestell-Nr. Order-no.	Blattlänge mm Blade length mm
26-108030-0	300
26-108035-0	350

Standard Handsäge

- mit Standardzahnung
- gerade
- geschlossenes Holzheft

Standard hand saw

- normal toothing straight
- with closed wooden handle



Bestell-Nr. Order-no.	Blattabmessungen mm Blade dimension mm
26-112002-0	400 x 127 x 35
26-112004-0	450 x 127 x 35
26-112006-0	500 x 140 x 45
26-112008-0	550 x 140 x 45
26-112010-0	600 x 140 x 45

Handsäge

- mit Standardzahnung
- gerade
- mit Kunststoffheft

Hand saw

- with normal toothing
- with closed plastic handle



Bestell-Nr. Order-no.	Blattlänge mm Blade length mm
26-115030-0	300
26-115035-0	350
26-115040-0	400
26-115045-0	450
26-115050-0	500
26-115055-0	550

Bausäge

- mit Hartpunktzahnung
- zum Sägen von Gasbeton-Materialien
- mit geschlossenem Holzheft

Hardpoint handsaw

- for cutting gas concrete materials
- with closed wooden handle



Bestell-Nr. Order-no.	Blattlänge mm Blade length mm
26-120070-0	700

Astsäge

- mit doppelter Zahnung
- mit geschlossenem Holzheft

Pruning (Branch) saw

- with double toothing
- with closed wooden handle



Bestell-Nr. Order-no.	Blattlänge mm Blade length mm
26-117025-0	250
26-117030-0	300
26-117035-0	350

Bausäge

- mit 34 Zähnen, davon 17 Hartmetallzähnen
- zum Sägen von Gasbeton-Materialien
- mit geschlossenem Holzheft

TCT handsaw

- with 34 teeth thereof 17 teeth carbide tipped
- for cutting gas concrete materials
- with closed wooden handle



Bestell-Nr. Order-no.	Blattlänge mm Blade length mm
26-120071-0	700

Rücksäge

- mit Standardzahnung
- mit geschlossenem Holzheft

Back saw

- with normal toothing
- with closed wooden handle



Bestell-Nr. Order-no.	Blattlänge mm Blade length mm
26-119530-0	300
26-119535-0	350



Bausäge

- mit 34 Hardmetallzähnen
- zum Sägen von Gasbeton-Materialien
- mit geschlossenem Holzheft

TCT handsaw

- with 34 teeth carbide tipped
- for cutting gas concrete materials
- with closed wooden handle



Bestell-Nr.
Order-no.
26-120072-0

Blattlänge mm
Blade length mm
700

Sägenschränkwange

mit Skala und Stellschraube

Saw set pliers

with scala and adjusting sciew

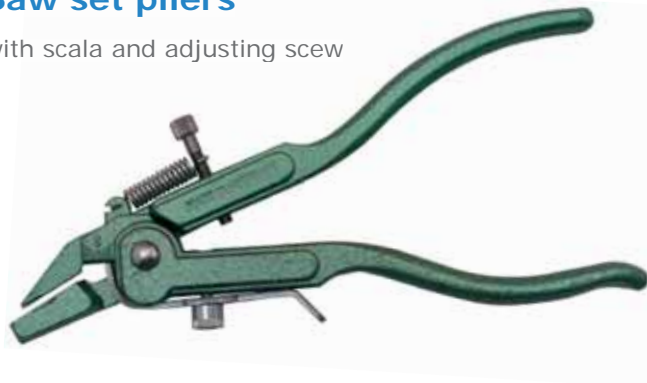

Bestell-Nr.
Order-no.
26-121019-0

Abmessung mm
Size mm
190

Sägensetzer

zum Biegen/Setzen der Sägezähne

Saw set

for setting of saw tooth



Bestell-Nr.
Order-no.
26-123000-0

Nestsägen

Satz 5-teilig

Nest of saws

set of 5 pieces



Bestell-Nr.
Order-no.
26-124005-0

Ausführung
Execution

offenes Holzheft/open wooden handle

26-125005-0

Plastikheft/PVC handle

Furniersäge

- gekröpft
- Blatt oval
- mit Holzgriff

Veneer cutter

- offset
- oval blade
- wooden handle



Bestell-Nr.
Order-no.
26-126000-0

Artikel
Item

Furniersäge/Veneer cutter 75

26-126500-0

Ersatzblatt/spare blade 75

Feinsäge

- gerade
- normale Zahnung
- mit Holzheft

Dovetail saw

- straight
- normal toothing
- wooden handle



Bestell-Nr.
Order-no.

26-127025-0

Blattlänge mm
Blade length mm

250

Feinsäge

- gekröpft
- umlegbar
- normale Zahnung
- mit Holzheft

Dovetail saw

- offset
- reversible
- normal toothing
- wooden handle



Bestell-Nr.
Order-no.

26-128025-0

Blattlänge mm
Blade length mm

250

Feinsäge

- gekröpft
- normale Zahnung
- mit Holzheft

Dovetail saw

- offset
- normal toothing
- wooden handle



Bestell-Nr.
Order-no.

26-127525-0

Blattlänge mm
Blade length mm

250

Schneidlade mit Feinsäge

- für Gehrungsschnitte
- aus Kunststoff

Mitre box with dovetail saw

- for mitre cutting
- box made of plastic

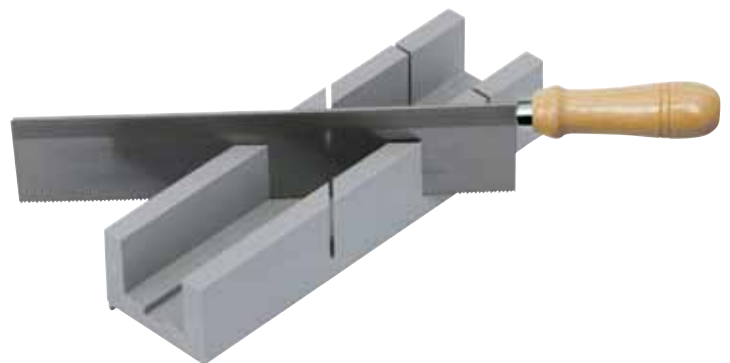

Bestell-Nr.
Order-no.

26-128525-0

Länge mm
Length mm

250

Gehrungs-Schneidlade

- für Gehrungsschnitte
- aus Kunststoff

Mitre box

- for mitre cutting
- made of plastic



Bestell-Nr. Order-no.	Länge mm Length mm
26-129025-0	250

Dübelzieher

mit T-Griff

Dowel extractor

with T-handle



Bestell-Nr. Order-no.	Größe Size	Ø mm Ø mm	für Dübel bis Ø mm for dowels up to Ø mm
26-132001-0	1	5,0	6,0
26-132002-0	2	6,5	14,0

Gehrungs-Schneidlade

- für Gehrungsschnitte
- aus Holz

Mitre box

- for mitre cutting
- made of wood



Bestell-Nr. Order-no.	Länge mm Length mm
26-130030-0	300

Fleisch- und Knochensäge

mit schwarzem Kunststoffheft

Butcher's saw

- for meat and bones
- with black plastic handle



Bestell-Nr. Order-no.	Blattlänge mm Blade length mm
26-133040-0	400
26-133045-0	450
26-133050-0	500
26-133055-0	550
26-135040-0	400 x 20 x 0,6 - Ersatzblatt/spare blade
26-135045-0	450 x 20 x 0,6 - Ersatzblatt/spare blade
26-135050-0	500 x 20 x 0,6 - Ersatzblatt/spare blade
26-135055-0	550 x 20 x 0,6 - Ersatzblatt/spare blade
26-135340-0	400 x 20 x 0,6 - Ersatzblatt/spare blade INOX
26-135345-0	450 x 20 x 0,6 - Ersatzblatt/spare blade INOX
26-135350-0	500 x 20 x 0,6 - Ersatzblatt/spare blade INOX
26-135355-0	550 x 20 x 0,6 - Ersatzblatt/spare blade INOX

Bohrstichsäge STICHLING

mit Plastikheft

Compass saw

with gimlet plastic handle



Bestell-Nr. Order-no.	Größe Size	Blattlänge mm Blade length mm	Ø mm Ø mm
26-131000-0	0	190	4,5
26-131001-0	1	270	5,0
26-131002-0	2	360	6,5
26-131003-0	3	450	8,0

Bügelsäge MINI

- aus Metallrohr
- lackiert
- mit Sägeblatt

Bow saw MINI

- all metal
- varnished
- with saw blade

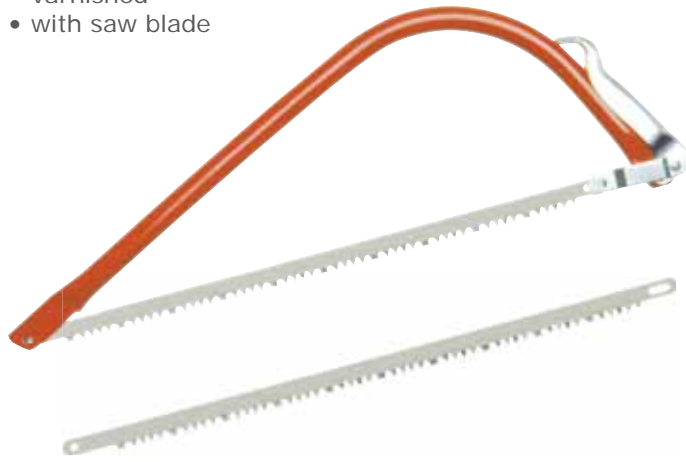

Bestell-Nr. Order-no.	Blattlänge mm Blade length mm
26-140045-0	450
26-140053-0	530
26-145045-0	450 - Ersatzblatt/spare blade
26-145053-0	530 - Ersatzblatt/spare blade



Bügelsäge

- aus Metallrohr
- lackiert
- mit Sägeblatt

Bow saw

- all metal
- varnished
- with saw blade

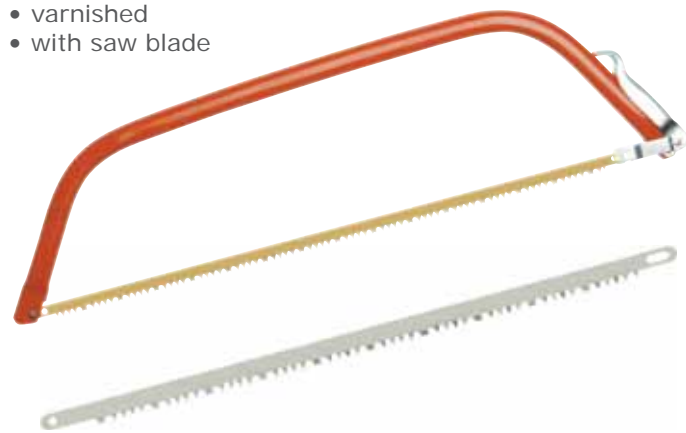

Bestell-Nr. Order-no.	Blattlänge mm Blade length mm
26-150076-0	760
26-150091-0	910
26-155076-0	760 - Ersatzblatt/spare blade
26-155091-0	910 - Ersatzblatt/spare blade

Gehrungssäge PERFEKT

- mit Spannsäge und Universalsägeblatt
- mit verstellbarem Längenanschlag

Mitre saw PERFECT

- with length setting attachment
- with universal saw blade

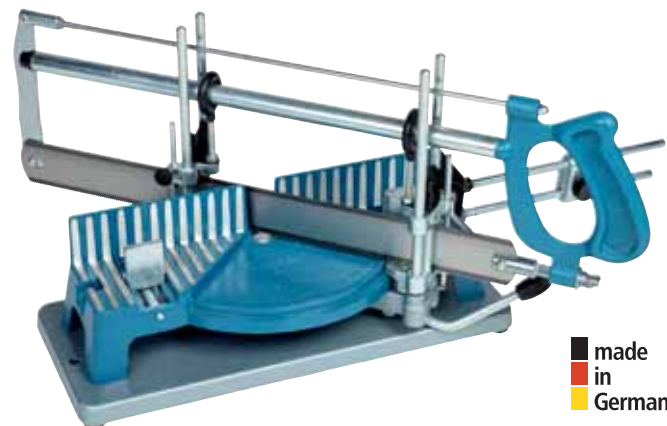

made
in
Germany

Bestell-Nr. Order-no.	Blattlänge mm Blade length mm
26-161555-0	550
26-162055-0	Ersatzblatt Holz/spare blade for wood
26-162555-0	Ersatzblatt Aluminium/spare blade for Aluminium

Wetzstahl

- aus Diamant-Hartchrom
- rund
- mit Aufhängering am Holzheft

Butcher's steel

- made of diamant-Hartchrome
- round
- with ring on wooden handle

Bestell-Nr. Order-no.	Länge Zoll Length inch
26-163006-0	6
26-163007-0	7
26-163008-0	8



Wetzstahl

- aus Diamant-Hartchrom
- rund
- mit Aufhängering am Holzheft

Butcher's steel

- made of diamant-Hartchrome
- round
- with ring on wooden handle

Bestell-Nr. Order-no.	Länge Zoll Length inch
26-163510-0	10
26-163512-0	12
26-163514-0	14



Wetzstahl

- aus Diamant-Hartchrom
- oval
- mit Aufhängering am Kunststoffheft

Butcher's steel

- made of diamant-Hartchrome
- oval
- with ring on PVC-handle

Bestell-Nr. Order-no.	Länge Zoll Length inch
26-164510-0	10
26-164512-0	12



Wetzstahl

- aus Diamant-Hartchrom
- rund
- mit Platte
- mit Aufhängering am Holzheft

Butcher's steel

- made of diamant-Hartchrome
- round
- with plate
- with ring on wooden handle

Bestell-Nr. Order-no.	Länge Zoll Length inch
26-164010-0	10
26-164012-0	12
26-164014-0	14



Wetzstahl

- aus Diamant-Hartchrom
- rund
- mit Aufhängering am Kunststoffheft

Butcher's steel

- made of diamant-Hartchrome
- round
- with ring on PVC-handle

Bestell-Nr. Order-no.	Länge Zoll Length inch
26-165010-0	10
26-165012-0	12



Fleischhaken DIN 5046

- rostfrei
- S-Form

Butcher's hook DIN 5046

- stainless steel
- S-form

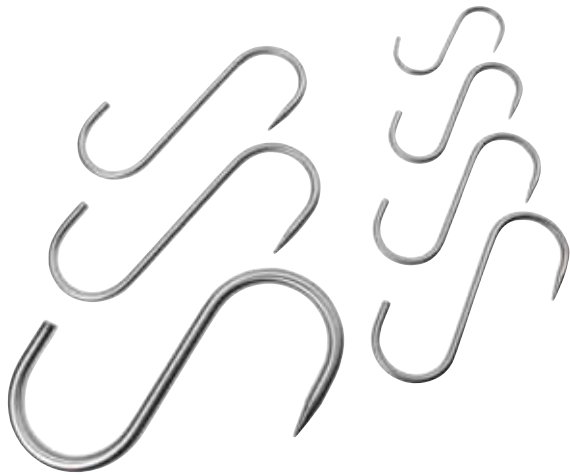

Bestell-Nr. Order-no.	Abmessung mm Size mm
26-166512-0	120 x 5,0
26-166514-0	140 x 5,5
26-166515-0	140 x 6,0
26-166516-0	160 x 6,0
26-166518-0	180 x 6,5
26-166520-0	200 x 8,0

Ziehklingenstahl

- rund
- lackiertes Holzheft

Scraper steel

- round
- wooden handle



Bestell-Nr. Order-no.	Blattlänge mm Blade length mm
26-167015-0	150

Metall- und Kunststoffsäge

- mit Blatt
- mit schwarzem Kunststoffgriff

Saw with metal blade

- for cutting metal and PVC
- with plastic handle



Bestell-Nr. Order-no.	Blattlänge mm Blade length mm
26-170015-0	150

Metall- und Kunststoffsäge, Spitzform

- mit Blatt
- mit schwarzem Kunststoffheft

Saw with metal blade, pointed type

- for cutting metal and PVC
- with plastic handle



Bestell-Nr. Order-no.	Blattlänge mm Blade length mm
26-171015-0	150

Säge JUNIOR

- mit Blatt
- verzinkter Bügel

Saw JUNIOR

- with blade
- bow zinc plated



Bestell-Nr. Order-no.	Blattlänge mm Blade length mm
26-173015-9	150

ORIGINAL PUK Säge

- feststehend
- mit rotem Holzgriff

ORIGINAL PUK saw

- fixed
- with red handle



Bestell-Nr.
Order-no.
26-174015-0

Blattlänge mm
Blade length mm
150

ORIGINAL PUK Sägeblätter Typ 310

- für Metall und Buntmetalle
Alu
Kunststoffe
Gipse

ORIGINAL PUK saw blade type 310

- for cutting metal
alu
PVC and others

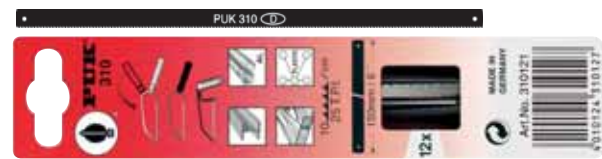

Bestell-Nr.
Order-no.
26-176010-0

Blattlänge mm
Blade length mm
150

ORIGINAL PUK Säge

mit verstellbarem Holzgriff

ORIGINAL PUK saw

with adjustable wooden handle

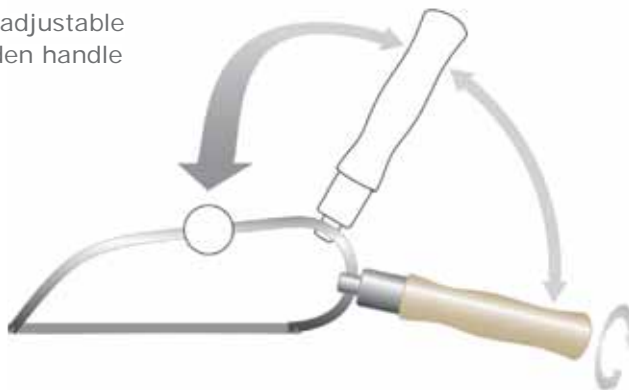

Bestell-Nr.
Order-no.
26-174515-0

Blattlänge mm
Blade length mm
150

ORIGINAL PUK Sägeblätter Typ 312

- für alle Metalle
Kupfer
Edelstähle
Plexiglas und Kunststoffe

ORIGINAL PUK saw blade type 312

- for various kinds of metal
copper
stainless steel
acrylglass and PVC



Bestell-Nr.
Order-no.
26-176512-0

Blattlänge mm
Blade length mm
150



ORIGINAL PUK Sägeblätter Typ 313

für Holz

ORIGINAL PUK saw blade type 313

for wood



Bestell-Nr.
Order-no.
26-177013-0

Blattlänge mm
Blade length mm
150

Rundrohr-Laubsägebogen

- schwarz lackiert
- mit Holzgriff

Coping saw frame

- black varnished
- with wooden handle



Bestell-Nr.
Order-no.

26-178030-0

Abmessung mm
size mm

300 x 13

Laubsägeblätter TAI FUN 50

- doppelgezahnt
- für Holz

Coping saw blades TAI FUN 50

- double toothed
- for wood



Bestell-Nr.
Order-no.

26-187000-0

26-187001-0

26-187002-0

26-187003-0

26-187004-0

26-187005-0

26-187006-0

26-187007-0

26-187009-0

26-187011-0

26-187020-0

Größe
size

0

1

2

3

4

5

6

7

9

11

2/0

Feinmechaniker-Sägebogen

- verstellbar
- Bogen poliert

Jeweller saw frame

- adjustable
- polished



Bestell-Nr.
Order-no.

26-180008-0

26-180010-0

26-180012-0

26-180015-0

26-185008-0

26-185010-0

26-185012-0

26-185015-0

Abmessung mm
size mm

160 x 80

160 x 100

160 x 120

160 x 150

160 x 80

160 x 100

160 x 120

160 x 150

Ausführung
Execution

mit Spannhaken/with tenterhook

mit Spannhaken/with tenterhook

mit Spannhaken/with tenterhook

mit Spannhaken/with tenterhook

mit Kopfschraube/with head screw

mit Kopfschraube/with head screw

mit Kopfschraube/with head screw

mit Kopfschraube/with head screw

Laubsägeblätter CRAFTA

- für Holz
- für Plastic etc.

Coping saw blades CRAFTA

- for wood
- for PVC etc.



Bestell-Nr.
Order-no.

26-187500-0

26-187501-0

26-187502-0

26-187503-0

26-187504-0

26-187505-0

26-187506-0

26-187507-0

26-187509-0

26-187511-0

Größe
size

0

1

2

3

4

5

6

7

9

11

Laubsägeblätter HERKULES

für Metall

Coping saw blades HERKULES

for metal (jewelry and goldsmith)



Bestell-Nr. Order-no.	Größe size
26-188000-0	0
26-188001-0	1
26-188002-0	2
26-188003-0	3
26-188004-0	4
26-188005-0	5
26-188006-0	6
26-188007-0	7
26-188008-0	8
26-188020-0	2/0
26-188030-0	3/0

Laubsäge-Drillbohrer

Fretwork drill



Bestell-Nr. Order-no.	Länge mm Length mm	Bohrer Stück drills pieces
26-194024-0	240	2
26-194025-0	240	5
26-196025-0	Ersatzbohrersatz/spare drills set	25

Laubsägeblätter PINGUIN GOLD

- rund gezahnt
- für Holz

Coping saw blades PINGUIN GOLD

- round toothed
- for wood



Bestell-Nr. Order-no.	Größe size
26-190000-0	0
26-190001-0	1
26-190002-0	2
26-190003-0	3
26-190004-0	4
26-190005-0	5
26-190006-0	6
26-190007-0	7
26-190008-0	8
26-190009-0	9
26-190010-0	10
26-190020-0	2/0

Holz - Laubsägetisch

Fretwork wooden table



Bestell-Nr. Order-no.	Abmessung mm size mm
26-197017-0	170 x 65 x 10
26-197021-0	210 x 65 x 10

Laubsägezwinge

verzinkt

Coping saw clamp

zinc plated



Bestell-Nr. Order-no.	Abmessung mm size mm
26-199050-0	50
26-199075-0	75
26-199010-0	100



Laubsägesatz auf Karte

- Laubsäge
- Holzbrettchen
- Zwinge
- Blätter
- Schlüssel
- Drillbohrer

Fretwork tool set

- set of fretwork frame
- table
- clamp
- blades
- key
- drills



Bestell-Nr.
Order-no.

26-201000-0

Laubsägeset im Karton

- Laubsäge
- Holzbrettchen
- Zwinge
- Blätter
- Schlüssel
- Winkel
- Ahle
- Rundfeile
- Hammer
- Drillbohrer
- Schlitzschraubendreher
- Pinsel groß und klein
- Ringbohrer
- Bleistift
- Klebstoff

Laubsägesatz auf Karte

- Laubsäge
- Brettchen
- Zwinge
- Blätter
- Hammer
- Schlitzschraubendreher
- Drillbohrer

Fretwork tool set

- set of fretwork frame
- table
- clamp
- blades
- drill
- hammer
- screwdriver



Bestell-Nr.
Order-no.

26-200000-0



Fretwork tool set

- set of
- fretwork frame
- table
- clamp
- blades
- key
- square
- piercer
- file
- hammer
- different drills
- screwdrivers
- various brushes
- pencil
- glue

Bestell-Nr.
Order-no.

26-202000-0



Laubsäge-Werkzeugschrank

komplett eingerichtet, aus Holz

Fretwork tool set

in wooden tool cabinet

Bestell-Nr.
Order-no.

26-203000-0



Installateur-Metallsägebogen

- 45° Gehrungswinkel
- mit Schnellverstellung

Plumber metal hacksaw frame

- straight and 45° cutting
- with quick adjustment



Bestell-Nr.
Order-no.

26-207000-9

Blattlänge mm
Blade length mm

300

Metallsägebogen PROF I

- 18 x 8 mm
- mit unverlierbarem Spannstift
- Bogen lackiert
- Holzgriff

Hacksaw frame PROF I

- bow 18 x 8 mm
- varnished
- with wooden handle



Bestell-Nr.
Order-no.

26-210000-0

Blattlänge mm
Blade length mm

300

Metallsägebogen PROF I

- feststehend
- aus Vierkantrrohr 18 x 10 mm
- mit Blatt
- mit Alu-Handgriff

Hacksaw frame PROF I

- heavy rectangular tube
- measure 18 x 10 mm
- with aluminium handle
- with blade



Bestell-Nr.
Order-no.

26-209000-0

Blattlänge mm
Blade length mm

300

Metallsägebogen PROF I

- 18 x 8 mm
- mit Sägeblatt
- mit unverlierbarem Spannstift
- Bogen lackiert
- Holzgriff

Hacksaw frame PROF I

- bow 18 x 8 mm
- with saw blade
- varnished
- with wooden handle



Bestell-Nr.
Order-no.

26-211000-0

Blattlänge mm
Blade length mm

300

Metallsägeblatt

- einseitig
- günstige Qualität

Hacksaw blade

- single edge
- simple quality



Bestell-Nr. Order-no.	Länge x Breite x Stärke mm Length x width x strength mm	Zähne je Zoll Teeth per inch
26-212018-0	300 x 13 x 0,63	18
26-212024-0	300 x 13 x 0,63	24

Metallsägeblatt

- doppelseitig
- günstige Qualität

Hacksaw blade

- double edge
- simple quality



Bestell-Nr. Order-no.	Länge x Breite x Stärke mm Length x width x strength mm	Zähne je Zoll Teeth per inch
26-215018-0	300 x 25 x 0,63	18
26-215024-0	300 x 25 x 0,63	24

Metallsägeblatt HSS Bi-PROFI

- einseitig
- blau lackiert

Metal saw blade HSS Bi-PROFI

- single edge
- blue varnished



Bestell-Nr. Order-no.	Länge x Breite x Stärke mm Length x width x strength mm	Zähne je Zoll Teeth per inch
26-213018-0	300 x 13 x 0,63	18
26-213024-0	300 x 13 x 0,63	24
26-213032-0	300 x 13 x 0,63	32

Sägeblatthalter

- für Sägeblatt 300 mm
- ohne Blatt
- aus Kunststoff

Saw blade holder

- for saw blade 300 mm
- without blade
- made of PVC



Bestell-Nr. Order-no.	für Sägeblatt mm for saw blade mm
26-216030-0	300

Holzbandsägen

- geschränkt und geschärft

Band saws for cutting wood

- set and sharpened
- best german quality

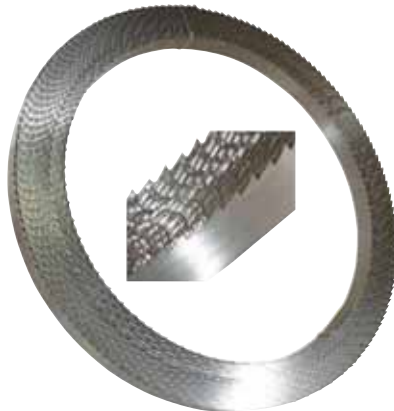

Bestell-Nr. Order-no.	Breite x Stärke mm Width x strength mm	Rollenlänge m Roll of m
26-218010-0	10 x 0,6	50
26-218012-0	12 x 0,6	50
26-218015-0	15 x 0,6	50
26-218020-0	20 x 0,7	50
26-218025-0	25 x 0,7	50
26-218030-0	30 x 0,7	50
26-218035-0	35 x 0,8	50
26-218040-0	40 x 0,8	50
26-218045-0	45 x 0,8	50
26-218050-0	50 x 0,9	50
26-218120-0	20 x 0,7	22
26-218125-0	25 x 0,7	22
26-218130-0	30 x 0,7	22
26-218135-0	35 x 0,8	22
26-218140-0	40 x 0,8	22
26-218145-0	45 x 0,8	22
26-218150-0	50 x 0,9	22
26-218160-0	60 x 1,0	22

Maschinensägeblatt PROF I

HSS-E - DM05

Machine saw blade PROF I

HSS-E - DM05



Bestell-Nr. Order-no.	Länge x Breite x Stärke mm Length x width x strength mm	Zähne je Zoll Teeth per inch
26-221030-0	350 x 20 x 1,25	10
26-221018-0	350 x 25 x 1,25	10
26-221019-0	400 x 25 x 1,25	14
26-221040-0	400 x 30 x 1,5	10
26-221033-0	400 x 30 x 1,5	14
26-221009-0	400 x 32 x 1,6	10
26-221031-0	400 x 32 x 1,5	10



Holz-Streichmaß

- mit Skala
- mit 2 Maßen

Wood marking gauge

- with scale
- with double graduation



Bestell-Nr. Order-no.
26-241000-0

Anreißlänge mm marking length mm
0-170

Nageleisen

- lackiert
- mit Klaue und Flachmeissel
- 6-kant Stahl

Wrecking bar

- varnished
- with claw and flat chisel
- hexagonal bar



Bestell-Nr. Order-no.	Länge x Stärke mm Length x strength mm
26-241540-0	400 x 17
26-241550-0	500 x 17
26-241560-0	600 x 17
26-241580-0	800 x 17
26-241510-0	1.000 x 17

Stechbeitel

- mit Seitenfase
- Klinge fein poliert
- mit Holzheft

Wood chisel

- with side bevel
- blade fine polished
- with wooden handle



Bestell-Nr. Order-no.	Abmessung mm Size mm
26-243004-0	4
26-243006-0	6
26-243008-0	8
26-243010-0	10
26-243012-0	12
26-243013-0	13
26-243014-0	14
26-243016-0	16
26-243018-0	18
26-243020-0	20
26-243022-0	22
26-243024-0	24
26-243026-0	26
26-243028-0	28
26-243030-0	30
26-243032-0	32

Stechbeitel

- mit Seitenfase
- Klinge fein poliert
- mit Kunststoffheft

Wood chisel

- with side bevel
- blade fine polished
- with plastic handle



Bestell-Nr. Order-no.	Abmessung mm Size mm
26-242004-0	4
26-242006-0	6
26-242008-0	8
26-242010-0	10
26-242012-0	12
26-242013-0	13
26-242014-0	14
26-242016-0	16
26-242018-0	18
26-242020-0	20
26-242022-0	22
26-242024-0	24
26-242026-0	26
26-242028-0	28
26-242030-0	30
26-242032-0	32

Fitschenbeitel

- gefräst
- poliert

Plugging chisel

- notched face
- polished



Bestell-Nr. Order-no.	Abmessung mm Size mm
26-244015-0	1,5
26-244020-0	2,0



Streifenhobelmesser

- fein poliert
- Chrom-Vanadium

Block cutting knives

- polished blade
- Chrom-Vanadium



Bestell-Nr. Order-no.	Länge x Breite mm Length x Width mm
26-247010-0	100 x 30
26-247015-0	150 x 30
26-247020-0	200 x 30
26-247025-0	250 x 30
26-247030-0	300 x 30
26-247035-0	350 x 30
26-247040-0	400 x 30
26-247045-0	450 x 30
26-247050-0	500 x 30
26-247055-0	550 x 30
26-247060-0	600 x 30
26-247065-0	650 x 30
26-247070-0	700 x 30
26-247075-0	750 x 30
26-247080-0	800 x 30
26-247000-0	1.000 x 30
26-247110-0	100 x 35
26-247115-0	150 x 35
26-247120-0	200 x 35
26-247125-0	250 x 35
26-247130-0	300 x 35
26-247135-0	350 x 35
26-247140-0	400 x 35
26-247145-0	450 x 35
26-247150-0	500 x 35
26-247155-0	550 x 35
26-247160-0	600 x 35
26-247165-0	650 x 35
26-247170-0	700 x 35
26-247175-0	750 x 35
26-247180-0	800 x 35
26-247100-0	1.000 x 35

Schleifstein

kombiniert

Grinding stone

combined



Bestell-Nr. Order-no.	Abmessung mm Size mm	Detail Detail
26-245015-9	150 x 50 x 25	STANDARD
26-245015-0	150 x 50 x 20	CORAP/APEX
26-245020-0	200 x 50 x 20	CORAP/APEX

Kreissägeblatt für Holz

- Zahn A (KV)
- Chrom-Vanadium

Circular saw blade for wood

- Teeth A (KV)
- Chrom-Vanadium



Bestell-Nr. Order-no.	Ø x Stärke x Bohrung mm Ø x thickness x bore mm	Zähne je Zoll Teeth per inch
26-250010-0	100 x 0,8 x 12	56
26-250012-0	125 x 0,9 x 12	56
26-250015-0	150 x 1,0 x 16	56
26-250017-0	175 x 1,0 x 16	56
26-250020-0	200 x 1,2 x 20	56
26-250025-0	250 x 1,4 x 20	56
26-250030-0	300 x 1,6 x 25	56
26-250035-0	350 x 1,8 x 25	56
26-250040-0	400 x 2,0 x 25	56
26-250045-0	450 x 2,2 x 25	56
26-250050-0	500 x 2,5 x 30	56
26-250055-0	550 x 2,6 x 30	56
26-250060-0	600 x 2,8 x 30	56
26-250065-0	650 x 3,0 x 30	56
26-250070-0	700 x 3,2 x 35	56
26-250075-0	750 x 3,4 x 35	56
26-250080-0	800 x 3,5 x 40	56
26-250085-0	850 x 3,8 x 40	56
26-250090-0	900 x 4,0 x 40	56
26-250000-0	1000 x 4,2 x 40	56
andere Größen auf Anfrage other size on request		

Kreissägeblatt für Holz

- Zahn A
- Chromstahl

Circular saw blade for wood

- Teeth A
- chrome steel



Bestell-Nr. Order-no.	Ø x Stärke x Bohrung mm Ø x thickness x bore mm	Zähne je Zoll Teeth per inch
26-250510-0	100 x 0,8 x 12	56
26-250512-0	125 x 0,9 x 12	56
26-250515-0	150 x 1,0 x 16	56
26-250517-0	175 x 1,0 x 16	56
26-250520-0	200 x 1,2 x 20	56
26-250525-0	250 x 1,4 x 20	56
26-250530-0	300 x 1,6 x 25	56
26-250535-0	350 x 1,8 x 25	56
26-250540-0	400 x 2,0 x 25	56
26-250545-0	450 x 2,2 x 25	56
26-250550-0	500 x 2,5 x 30	56
26-250555-0	550 x 2,6 x 30	56
26-250560-0	600 x 2,8 x 30	56
26-250565-0	650 x 3,0 x 30	56
26-250570-0	700 x 3,2 x 35	56
26-250575-0	750 x 3,4 x 35	56
26-250580-0	800 x 3,5 x 40	56
26-250585-0	850 x 3,8 x 40	56
26-250590-0	900 x 4,0 x 40	56
26-250500-0	1000 x 4,2 x 40	56
andere Größen auf Anfrage other size on request		

Kreissägeblatt für Holz

- hartmetallbestückt
- Blatt blankpoliert, gesandstrahl

Carbide-tipped circular saw blade for wood

- blade polished, sand blasted



Bestell-Nr. Order-no.	Blatt Ø mm Blade Ø mm	Bohrung Ø mm bore hole Ø mm	Zähne je Zoll Teeth per inch
26-251001-0	190	30	14
26-251002-0	190	30	24
26-251003-0	190	30	30
26-251004-0	190	30	40
26-251005-0	200	30	30
26-251006-0	230	30	20
26-251007-0	230	30	34
26-251008-0	230	30	48
26-251009-0	230	30	64
26-251010-0	250	30	32
26-251011-0	250	30	40
26-251012-0	250	30	48
26-251013-0	250	30	80
26-251014-0	300	30	24
26-251015-0	300	30	36
26-251016-0	300	30	48
26-251017-0	300	30	64
26-251018-0	300	30	72
26-251019-0	300	30	96
26-251020-0	350	30	40
26-251021-0	350	30	54
26-251022-0	350	30	72
26-251023-0	350	30	84
26-251024-0	400	30	48

Kreissägeblatt für Aluminium

- hartmetallbestückt
- Blatt blankpoliert, gesandstrahl

Carbide-tipped circular saw blades for aluminium work

- blade polished, sand blasted



Bestell-Nr. Order-no.	Blatt Ø mm Blade Ø mm	Bohrung Ø mm bore hole Ø mm	Zähne je Zoll Teeth per inch
26-253001-0	200	30	60
26-253002-0	250	30	60
26-253003-0	300	30	80
26-253004-0	300	30	72
26-253005-0	300	30	96
26-254001-0	200	40	60
26-254002-0	250	40	60
26-254003-0	250	40	80
26-254004-0	300	40	72
26-254005-0	300	40	96



Kreissägeblatt für Melamin

- hartmetallbestückt
- Blatt blankpoliert, gesandstrahlt

Carbide tipped circular saw blades

- for melamin work
- blade polished, sand blasted



Bestell-Nr. Order-no.	Blatt Ø mm Blade Ø mm	Bohrung Ø mm bore hole Ø mm	Zähne je Zoll Teeth per inch
26-255001-0	200	30	64
26-255002-0	250	30	60
26-255003-0	250	30	80
26-255004-0	300	30	72
26-255005-0	300	30	96
26-256001-0	200	40	64
26-256002-0	250	40	60
26-256003-0	250	40	80
26-256004-0	300	40	72
26-256005-0	300	40	96

Reduzierringe

für Sägeblätter

Reducing ring

for saw blades



Bestell-Nr. Order-no.	Reduzierend von/bis mm reducing hole from/to mm
26-258200-0	30 - 20
26-258201-0	40 - 30
26-258202-0	40 - 20
26-258203-0	30 - 25



Schlüsselfeilensatz

- Einrieb
- mit Holzheft
- in Tasche



Warding file set

- single cut
- wooden handle
- in plastic wallet

Bestell-Nr. Order-no.	Composición Execution	Blattlänge mm Blade length mm
26-270006-9	verschiedene Feilen/ different files	110
26-271006-9	mit 2 Rundfeilen/ with 2 files round	110

Dreikant-Sägefeile

- extra dünn
- Hieb 2
- ohne Heft

Three square taper saw file

- extra slim
- 2nd cut
- without handle



Bestell-Nr. Order-no.	Blattlänge mm Blade length mm
26-277010-9	100
26-277012-9	125
26-277015-9	150
26-277020-9	200

Kettensägefeile

ohne Heft

Chain saw file

without handle



Bestell-Nr. Order-no.	Ø mm x Länge mm Ø mm x length mm
26-273032-9	3,2 x 150
26-273035-9	3,5 x 150
26-273040-9	4,0 x 200
26-273048-9	4,8 x 200
26-273055-9	5,5 x 200

Werkstattfeile flachstumpf

- Hieb 2
- ohne Heft

Machinist's file flat

- 2nd cut
- without handle



Bestell-Nr. Order-no.	Blattlänge mm Blade length mm
26-281020-9	200
26-281025-9	250
26-281030-9	300

Dreikant-Sägefeile schmale Form

- Hieb 2
- ohne Heft

Three square taper saw file slim

- 2nd cut
- without handle



Bestell-Nr. Order-no.	Blattlänge mm Blade length mm
26-276010-9	100
26-276012-9	125
26-276015-9	150
26-276020-9	200

Werkstattfeile dreikant

- Hieb 2
- ohne Heft

Machinist's file triangle

- 2nd cut
- without handle



Bestell-Nr. Order-no.	Blattlänge mm Blade length mm
26-287020-9	200
26-287025-9	250
26-287030-9	300

Werkstattfeile vierkant

- Hieb 2
- ohne Heft



Machinist's file square

- 2nd cut
- without handle



Bestell-Nr. Order-no.	Blattlänge mm Blade length mm
26-292020-9	200
26-292025-9	250
26-292030-9	300

Holzraspel halbrund

- Hieb 2
- ohne Heft



Wood rasp halfround

- 2nd cut
- without handle

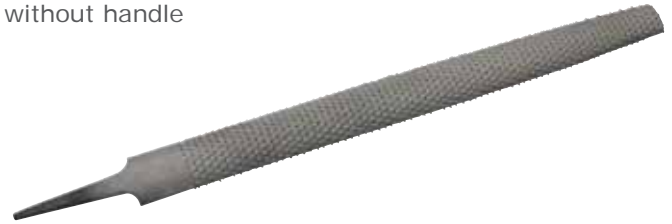

Bestell-Nr. Order-no.	Blattlänge mm Blade length mm
26-301020-9	200
26-301025-9	250
26-301030-9	300

Werkstattfeile halbrund

- Hieb 2
- ohne Heft



Machinist's file halfround

- 2nd cut
- without handle



Bestell-Nr. Order-no.	Blattlänge mm Blade length mm
26-295020-9	200
26-295025-9	250
26-295030-9	300

Holzraspel rund

- Hieb 2
- ohne Heft

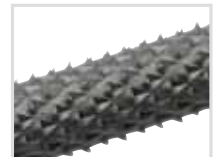

Wood rasp round

- 2nd cut
- without handle



Bestell-Nr. Order-no.	Blattlänge mm Blade length mm
26-303020-9	200
26-303025-9	250
26-303030-9	300

Werkstattfeile rund

- Hieb 2
- ohne Heft



Machinist's file round

- 2nd cut
- without handle



Bestell-Nr. Order-no.	Blattlänge mm Blade length mm
26-298020-9	200
26-298025-9	250
26-298030-9	300

Holzraspel flach

- Hieb 2
- ohne Heft

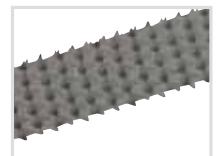

Wood rasp flat

- 2nd cut
- without handle



Bestell-Nr. Order-no.	Blattlänge mm Blade length mm
26-305020-9	200
26-305025-9	250
26-305030-9	300



Feilensatz

- 5-teilig (rund, flach, halbrund, 3-kant, 4-kant)
- rotes Holzheft
- in Tasche

Set of files

- set of 5 pieces (round, flat, halfround, triangle, square)
- red wooden handle
- in wallet



Bestell-Nr.
Order-no.
26-307905-9
26-308005-9

Blattlänge mm
Blade length mm
150
200

Kontaktfeile

- Hieb 3
- ohne Heft
- in Abreißtasche



Contact file

- 3rd cut
- without handle
- in wallet

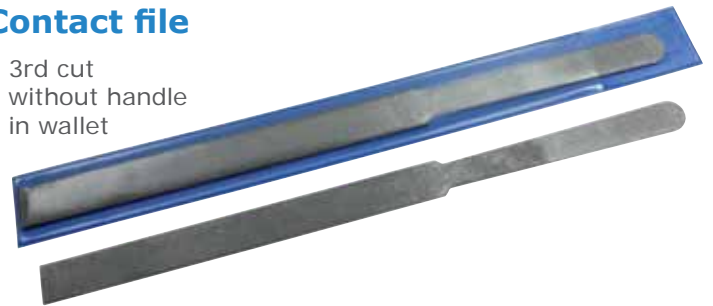

Bestell-Nr.
Order-no.
26-316115-9

Blattlänge mm
Blade length mm
150

Feilensatz

- 3-teilig (flach, 3-kant, rund)
- mit Holzheft
- in Papier

Set of files

- set of 3 pieces (flat, triangle, round)
- wooden handle
- wrapped in paper



Bestell-Nr.
Order-no.
26-308103-9

Blattlänge mm
Blade length mm
200

Feilenheft

- mit Zwinge
- aus Holz

File handle

- with collar
- made of wood



Bestell-Nr.
Order-no.
26-317007-0
26-317008-9
26-317009-0
26-317010-0
26-317011-0
26-317012-0
26-317013-0
26-317014-0
26-317015-0
26-317016-0

Heftlänge mm
Handle length mm
70
80
90
100
110
120
130
140
150
160

Feilenbürste

mit Holzrücken und Holzstiel

Wire brush for file

with wooden back and handle



Bestell-Nr.
Order-no.
26-318000-0

Abmessung mm
Size mm
1.150 x 40

Werkstattfeile flachstumpf

- mit Heft
- in SB-Tasche



Machinist's file flat

- with handle
- in wallet



Best.-Nr. Order-no.	Länge mm Length mm	Hieb Cut
26-400110-9	100	H1/bastard
26-400115-9	150	H1/bastard
26-400120-9	200	H1/bastard
26-400125-9	250	H1/bastard
26-400130-9	300	H1/bastard
26-400210-9	100	H2/2nd
26-400215-9	150	H2/2nd
26-400220-9	200	H2/2nd
26-400225-9	250	H2/2nd
26-400230-9	300	H2/2nd
26-400310-9	100	H3/smooth
26-400315-9	150	H3/smooth
26-400320-9	200	H3/smooth
26-400325-9	250	H3/smooth
26-400330-9	300	H3/smooth

Werkstattfeile dreikant

- mit Heft
- in SB-Tasche



Machinist's file triangle

- with handle
- in wallet



Best.-Nr. Order-no.	Länge mm Length mm	Hieb Cut
26-410110-9	100	H1/bastard
26-410115-9	150	H1/bastard
26-410120-9	200	H1/bastard
26-410125-9	250	H1/bastard
26-410130-9	300	H1/bastard
26-410210-9	100	H2/2nd
26-410215-9	150	H2/2nd
26-410220-9	200	H2/2nd
26-410225-9	250	H2/2nd
26-410230-9	300	H2/2nd
26-410310-9	100	H3/smooth
26-410315-9	150	H3/smooth
26-410320-9	200	H3/smooth
26-410325-9	250	H3/smooth
26-410330-9	300	H3/smooth

Werkstattfeile halbrund

- mit Heft
- in SB-Tasche



Machinist's file halfround

- with handle
- in wallet



Best.-Nr. Order-no.	Länge mm Length mm	Hieb Cut
26-415110-9	100	H1/bastard
26-415115-9	150	H1/bastard
26-415120-9	200	H1/bastard
26-415125-9	250	H1/bastard
26-415130-9	300	H1/bastard
26-415210-9	100	H2/2nd
26-415215-9	150	H2/2nd
26-415220-9	200	H2/2nd
26-415225-9	250	H2/2nd
26-415230-9	300	H2/2nd
26-415310-9	100	H3/smooth
26-415315-9	150	H3/smooth
26-415320-9	200	H3/smooth
26-415325-9	250	H3/smooth
26-415330-9	300	H3/smooth



Werkstattfeile vierkant

- mit Heft
- in SB-Tasche



Machinist's file square

- with handle
- in wallet



Best.-Nr. Order-no.	Länge mm Length mm	Hieb Cut
26-420110-9	100	H1/bastard
26-420115-9	150	H1/bastard
26-420120-9	200	H1/bastard
26-420125-9	250	H1/bastard
26-420130-9	300	H1/bastard
26-420210-9	100	H2/2nd
26-420215-9	150	H2/2nd
26-420220-9	200	H2/2nd
26-420225-9	250	H2/2nd
26-420230-9	300	H2/2nd
26-420310-9	100	H3/smooth
26-420315-9	150	H3/smooth
26-420320-9	200	H3/smooth
26-420325-9	250	H3/smooth
26-420330-9	300	H3/smooth

Werkstattfeile rund

- mit Heft
- in SB-Tasche



Machinist's file round

- with handle
- in wallet



Best.-Nr. Order-no.	Länge mm Length mm	Hieb Cut
26-425110-9	100	H1/bastard
26-425115-9	150	H1/bastard
26-425120-9	200	H1/bastard
26-425125-9	250	H1/bastard
26-425130-9	300	H1/bastard
26-425210-9	100	H2/2nd
26-425215-9	150	H2/2nd
26-425220-9	200	H2/2nd
26-425225-9	250	H2/2nd
26-425230-9	300	H2/2nd
26-425310-9	100	H3/smooth
26-425315-9	150	H3/smooth
26-425320-9	200	H3/smooth
26-425325-9	250	H3/smooth
26-425330-9	300	H3/smooth





Holzraspel halbrund

- mit Heft
- in SB-Tasche



Wood rasp halfround

- with handle
- in wallet



Best.-Nr. Order-no.	Länge mm Length mm	Hieb Cut
26-435115-9	150	H1/bastard
26-435120-9	200	H1/bastard
26-435125-9	250	H1/bastard
26-435130-9	300	H1/bastard
26-435215-9	150	H2/2nd
26-435220-9	200	H2/2nd
26-435225-9	250	H2/2nd
26-435230-9	300	H2/2nd
26-435315-9	150	H3/smooth
26-435320-9	200	H3/smooth
26-435325-9	250	H3/smooth
26-435330-9	300	H3/smooth

Holzraspel flachstumpf

- mit Heft
- in SB-Tasche



Wood rasp flat

- with handle
- in wallet



Best.-Nr. Order-no.	Länge mm Length mm	Hieb Cut
26-430115-9	150	H1/bastard
26-430120-9	200	H1/bastard
26-430125-9	250	H1/bastard
26-430130-9	300	H1/bastard
26-430215-9	150	H2/2nd
26-430220-9	200	H2/2nd
26-430225-9	250	H2/2nd
26-430230-9	300	H2/2nd

Holzraspel rund

- mit Heft
- in SB-Tasche



Wood rasp round

- with handle
- in wallet



Best.-Nr. Order-no.	Länge mm Length mm	Hieb Cut
26-440115-9	150	H1/bastard
26-440120-9	200	H1/bastard
26-440125-9	250	H1/bastard
26-440130-9	300	H1/bastard
26-440215-9	150	H2/2nd
26-440220-9	200	H2/2nd
26-440225-9	250	H2/2nd
26-440230-9	300	H2/2nd



Küchenbeil mit Kuhfußstiel

- Stiel aus Esche
- goldfarbig lackiert

Hatchet

- with ash wood handle
- gold varnished



Bestell-Nr. Order-no.	Gramm Gram
26-320006-9	600
26-320008-9	800
26-320010-9	1.000

Holzaxt mit Kuhfußstiel

- Stiel aus Esche
- goldfarbig lackiert

Wood axe

- with ash wood handle
- gold varnished



Bestell-Nr. Order-no.	Gramm Gram
26-322012-9	1.250
26-322014-9	1.400
26-322016-9	1.600



Beilstiel

- aus Esche
- geschlitzt

Ash wood handle

for hatchet

Bestell-Nr. Order-no.	für Beil gramm for hatched gram
26-321006-0	600
26-321008-0	800
26-321010-0	1.000

Holzaxtstiel

- aus Esche
- geschlitzt

Ash wood handle

for axes

Bestell-Nr. Order-no.	für Axt gramm for axe gram
26-323012-0	1.250
26-323014-0	1.400
26-323016-0	1.600



Stangenscharnier

- Eisen vermessingt
- Lochabstand 70 x Gewerbe 17 mm

Piano hinges

- iron brassed
- hole spacing 70 mm



Bestell-Nr. Order-no.	Länge x Breite mm Length x width mm	Materialstärke mm material thickness mm
26-500000-0	3.500 x 32	0,7
26-500001-0	3.500 x 32	0,6

Nagelheber

- vernickelt
- mit Plastikheft

Nail/Spike puller

- nickel plated
- with plastic handle



Bestell-Nr. Order-no.	Abmessung mm Size mm
26-326000-0	100/190

Verschlusshülse

- verkupfert
- Länge 25 mm
- jeweils 1.000 Stück im Karton

Binding clip

- copper plated
- length of 25 mm
- box of 1.000 pieces

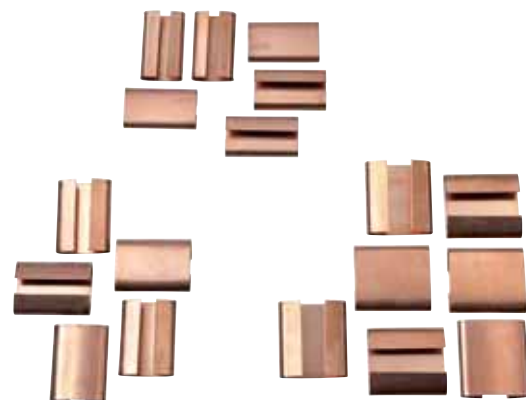

Bestell-Nr. Order-no.	Breite mm/Zoll Width mm/inch	Materialstärke mm material thickness mm
26-600013-0	13-1/2	0,5
26-600016-0	16-5/8	0,5
26-600019-0	19-3/4	0,5



**Steinbearbeitung**

Steinbohrer	184-185, 204-205
SDS-PLUS	186-188, 206-209
SDS-MAX	189-190, 210-211
SAPHIR	191
RUBIN	191

Stone working

Masonry Drills	184-185, 204-205
SDS-PLUS	206-209
SDS-MAX	189-190, 210-211
SAPHIR	191
RUBIN	191

**Metallbearbeitung**

HSS-R DIN 338	192-194, 211-214
HSS-R DIN 340	213
HSS-R DIN 1897	213
HSS DIN 345	195, 214
HSS-G DIN 338	195-196, 215
HSS TIN DIN 338	216
HSS-CO5% DIN 338	196-197, 216-217
Zentrierbohrer	219
Schraubenausdreher	201, 219
Einzahnfräser	202

Metal working

HSS-R DIN 338	192-194, 211-214
HSS-R DIN 340	213
HSS-R DIN 1897	213
HSS DIN 345	195, 214
HSS-G DIN 338	195-196, 215
HSS TIN DIN 338	216
HSS-CO5% DIN 338	196-197, 216-217
Center Drill	219
Screw extractors	201, 219
Single flute cutters	202

**Holzbearbeitung**

Holzspiralbohrer	197, 217
Flachfräsbohrer	218
Forstnerbohrer	218
Schalungsbohrer	198
Langlochbohrer	198
Zentriertbohrer	199
Scharnierlochbohrer	199
Senker	199-200
Nagelbohrer	200

Wood working

Wood working drill	197, 217
Flat wood working drill	218
Forstner drill	218
Frame wood drill	198
Machine mortise bits	198
Centre bit	199
Hinge hole cutters	199
Countersink drills	199-200
Gimlets	200

**Sonstiges**

Glasbohrer	201
Düsenreibahlen	201
Hand-/Brustbohrmaschine	203

Others

Glas drills	201
Nozzle Reamer	201
Hand-/Breastdrill	203

Steinbohrer ISO 5468

- mit Hartmetallschneide
- sandgestrahlt
- in Tasche

Masonry drill ISO 5468

- with hard metal edge
- sand blasted
- in wallet



 made
 in
 Germany

Bestell-Nr. Order-no.	Ø mm - Zoll Ø mm - inch	Länge mm length mm
27-101003-0	3,0-1/8	61
27-101004-0	4,0-5/32	76
27-101005-0	5,0-3/16	84
27-101055-0	5,5-7/32	84
27-101006-0	6,0-15/64	100
27-101065-0	6,5-1/4	100
27-101007-0	7,0-9/32	110
27-101008-0	8,0-5/16	115
27-101009-0	9,0-11/32	125
27-101010-0	10,0-3/8	125
27-101011-0	11,0-7/16	140
27-101012-0	12,0-15/32	140
27-101013-0	13,0-1/2	140
27-101014-0	14,0-9/16	150
27-101015-0	15,0-19/32	150
27-101016-0	16,0-5/8	150
27-101018-0	18,0-23/32	150
27-101020-0	20,0-3/4	160
27-101022-0	22,0-7/8	160
27-101024-0	24,0-15/16	160
27-101025-0	25,0-1	160

Bestell-Nr. Order-no.	Ø mm - Zoll Ø mm - inch	Länge mm length mm
27-1030052-0	5,0-3/16	200
27-1030062-0	6,0-15/64	200
27-1030652-0	6,5-1/4	200
27-1030082-0	8,0-5/16	200
27-1030102-0	10,0-3/8	200
27-1030122-0	12,0-15/32	200
27-1030132-0	13,0-1/2	200
27-1030142-0	14,0-9/16	200
27-1030162-0	16,0-5/8	200

27-1030064-0	6,0-15/64	400
27-1030654-0	6,5-1/4	400
27-1030084-0	8,0-5/16	400
27-1030104-0	10,0-3/8	400
27-1030124-0	12,0-15/32	400
27-1030134-0	13,0-1/2	400
27-1030144-0	14,0-9/16	400
27-1030164-0	16,0-5/8	400
27-1030184-0	18,0-23/32	400
27-1030204-0	20,0-3/4	400
27-1030224-0	22,0-7/8	400
27-1030244-0	24,0-15/16	400
27-1030254-0	25,0-1	400
27-1030264-0	26,0	400
27-1030284-0	28,0	400
27-1030304-0	30,0	400
27-1030324-0	32,0	400

27-107008-0	8,0-5/16	600
27-107010-0	10,0-3/8	600
27-107012-0	12,0-15/32	600
27-107013-0	13,0-1/2	600
27-107014-0	14,0-9/16	600
27-107016-0	16,0-5/8	600
27-107018-0	18,0-23/32	600
27-107020-0	20,0-3/4	600
27-107022-0	22,0-7/8	600
27-107024-0	24,0-15/16	600
27-107025-0	25,0-1	600
27-107026-0	26,0	600
27-107028-0	28,0	600
27-107030-0	30,0	600
27-107032-0	32,0	600

Steinbohrer-Satz ISO 5468

- mit Hartmetallschneide
- sandgestrahlt
- in Kassette

Masonry drill set ISO 5468

- with hard metal edge
- sand blasted
- in box

Bestell-Nr. Order-no.	Teile/Satz Pieces/set	Ø Bohrer mm Ø Drill mm
27-108004-0	4	4-5-6-8
27-108005-0	5	4-5-6-8-10
27-108008-0	8	3-4-5-6-7-8-9-10



made
in
Germany



Hammerbohrer

- für SDS-PLUS-Aufnahme
- HM 2-Schneider
- kugelgestrahlt
- am Klipp

Hammer drill

- for SDS-PLUS shank
- HM 2 cutter
- shot blasted
- on clip



made
in
Germany

Bestell-Nr. Order-no.	Ø x Länge x Spirallänge mm Ø x length x flute length mm	Bestell-Nr. Order-no.	Ø x Länge x Spirallänge mm Ø x length x flute length mm	Bestell-Nr. Order-no.	Ø x Länge x Spirallänge mm Ø x length x flute length mm
27-1100041-0	4 x 110 x 50	27-1100164-0	16 x 260 x 200	27-1100206-0	20 x 450 x 400
27-1100051-0	5 x 110 x 50	27-1100174-0	17 x 260 x 200	27-1100226-0	22 x 450 x 400
27-1100061-0	6 x 110 x 50	27-1100184-0	18 x 250 x 200	27-1100246-0	24 x 450 x 400
27-1100081-0	8 x 110 x 50	27-1100204-0	20 x 250 x 200	27-1100256-0	25 x 450 x 400
		27-1100224-0	22 x 250 x 200	27-1100266-0	26 x 450 x 400
27-1100052-0	5 x 160 x 100	27-1100244-0	24 x 250 x 200		
27-1100062-0	6 x 160 x 100	27-1100254-0	25 x 250 x 200	27-1100087-0	8 x 600 x 550
27-1100072-0	7 x 160 x 100	27-1100264-0	26 x 250 x 200	27-1100107-0	10 x 600 x 550
27-1100082-0	8 x 160 x 100			27-1100127-0	12 x 600 x 550
27-1100102-0	10 x 160 x 100	27-1100055-0	5 x 310 x 250	27-1100147-0	14 x 600 x 550
27-1100122-0	12 x 160 x 100	27-1100065-0	6 x 310 x 250	27-1100167-0	16 x 600 x 550
27-1100142-0	14 x 160 x 100	27-1100085-0	8 x 310 x 250	27-1100187-0	18 x 600 x 550
27-1100162-0	16 x 160 x 100	27-1100105-0	10 x 310 x 250	27-1100207-0	20 x 600 x 550
		27-1100115-0	11 x 310 x 250	27-1100227-0	22 x 600 x 550
27-1100063-0	6 x 210 x 150	27-1100125-0	12 x 310 x 250	27-1100257-0	25 x 600 x 550
27-1100083-0	8 x 210 x 150	27-1100135-0	13 x 310 x 250		
27-1100103-0	10 x 210 x 150	27-1100145-0	14 x 310 x 250	27-1100108-0	10 x 800 x 750
27-1100123-0	12 x 210 x 150	27-1100165-0	16 x 310 x 250	27-1100128-0	12 x 800 x 750
27-1100143-0	14 x 210 x 150	27-1100175-0	17 x 310 x 250	27-1100148-0	14 x 800 x 750
27-1100163-0	16 x 210 x 150	27-1100185-0	18 x 300 x 250	27-1100168-0	16 x 800 x 750
27-1100173-0	17 x 210 x 150	27-1100205-0	20 x 300 x 250	27-1100208-0	20 x 800 x 750
27-1100183-0	18 x 200 x 150	27-1100225-0	22 x 300 x 250	27-1100228-0	22 x 800 x 750
27-1100193-0	19 x 200 x 150			27-1100258-0	25 x 800 x 750
27-1100203-0	20 x 200 x 150	27-1100066-0	6 x 460 x 400		
		27-1100086-0	8 x 460 x 400	27-1100089-0	8 x 1.000 x 950
27-1100064-0	6 x 260 x 200	27-1100106-0	10 x 450 x 400	27-1100109-0	10 x 1.000 x 950
27-1100074-0	7 x 260 x 200	27-1100126-0	12 x 450 x 400	27-1100129-0	12 x 1.000 x 950
27-1100084-0	8 x 260 x 200	27-1100136-0	13 x 450 x 400	27-1100149-0	14 x 1.000 x 950
27-1100104-0	10 x 260 x 200	27-1100146-0	14 x 450 x 400	27-1100169-0	16 x 1.000 x 950
27-1100124-0	12 x 260 x 200	27-1100156-0	15 x 450 x 400	27-1100189-0	18 x 1.000 x 950
27-1100134-0	13 x 260 x 200	27-1100166-0	16 x 450 x 400	27-1100209-0	20 x 1.000 x 950
27-1100144-0	14 x 260 x 200	27-1100186-0	18 x 450 x 400	27-1100229-0	22 x 1.000 x 950
27-1100154-0	15 x 260 x 200	27-1100196-0	19 x 450 x 400	27-1100259-0	25 x 1.000 x 950

Hammerbohrer

- für SDS-PLUS-Aufnahme
- HM 4-Schneider
- kugelgestrahlt
- am Klipp

Hammer drill

- for SDS-PLUS shank
- HM 4 cutter
- shot blasted
- on clip

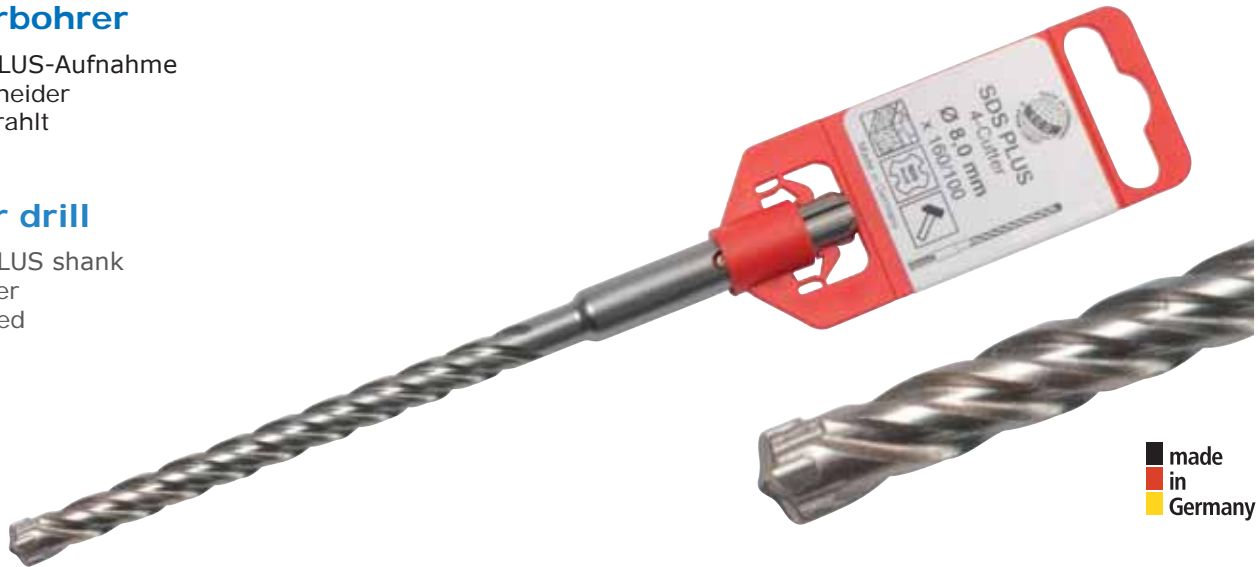

made
in
Germany

Bestell-Nr.
Order-no.

Ø x Länge x Spirallänge mm
Ø x length x flute length mm

27-1190051-0	5 x 110 x 50
27-1190061-0	6 x 110 x 50
27-1190071-0	7 x 110 x 50
27-1190081-0	8 x 110 x 50
27-1190101-0	10 x 110 x 50

27-1190052-0	5 x 160 x 100
27-1190062-0	6 x 160 x 100
27-1190072-0	7 x 160 x 100
27-1190082-0	8 x 160 x 100
27-1190102-0	10 x 160 x 100
27-1190122-0	12 x 160 x 100
27-1190142-0	14 x 160 x 100
27-1190162-0	16 x 160 x 100

Bestell-Nr.
Order-no.

Ø x Länge x Spirallänge mm
Ø x length x flute length mm

27-1190063-0	6 x 210 x 150
27-1190083-0	8 x 210 x 150
27-1190103-0	10 x 210 x 150
27-1190123-0	12 x 210 x 150
27-1190143-0	14 x 210 x 150
27-1190163-0	16 x 210 x 150

27-1190064-0	6 x 260 x 200
27-1190084-0	8 x 260 x 200
27-1190104-0	10 x 260 x 200
27-1190124-0	12 x 260 x 200
27-1190144-0	14 x 260 x 200
27-1190164-0	16 x 250 x 200

Hammer-Flachmeißel

- für SDS-PLUS-Aufnahme
- am Klipp

Hammer flat chisel

- for SDS-PLUS shank
- on clip



made
in
Germany

Bestell-Nr.
Order-no.

Länge x Klingenbreite mm
Length x blade width mm

27-114025-0	250 x 20
-----------------------------	----------

Hammer-Spatmeißel

- für SDS-PLUS-Aufnahme
- am Klipp

Hammer spade chisel

- for SDS-PLUS shank
- on clip



made
in
Germany

Bestell-Nr.
Order-no.

Länge x Klingenbreite mm
Length x blade width mm

27-114125-0	250 x 40
-----------------------------	----------

Hammer-Fliesenmeißel

- für SDS-PLUS-Aufnahme
- leicht gebogen
- am Klipp

Hammer tile chisel

- for SDS-PLUS shank
- slightly bent
- on clip

Bestell-Nr.
Order-no.

27-114225-0

Länge x Klingenbreite mm
Length x blade width mm

250 x 40



made
in
Germany

Hammer-Hohlmeißel

- für SDS-PLUS-Aufnahme
- leicht gebogen
- am Klipp

Hammer gouche chisel

- for SDS-PLUS shank
- slightly bent
- on clip

Bestell-Nr.
Order-no.

27-114425-0

Länge x Klingenbreite mm
Length x blade width mm

250 x 22



made
in
Germany

**Hammer-Spitzmeißel**

- für SDS-PLUS-Aufnahme
- am Klipp

Hammer pointed chisel

- for SDS-PLUS shank
- on clip

Bestell-Nr.
Order-no.

27-115025-0

Länge x Ø mm
Length x Ø mm

250 x 14



made
in
Germany

Hammerbohrer

- für SDS-MAX-Aufnahme
- HM 2-Schneider
- kugelgestrahlt
- am Klipp

Hammer drill

- for SDS-MAX shank
- 2 cutter
- shot blasted
- on clip

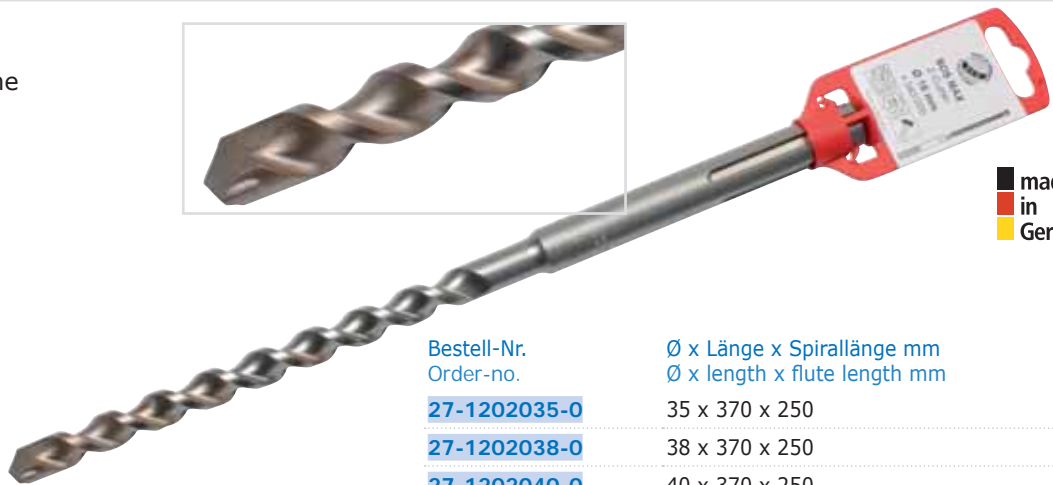

made
in
Germany

Bestell-Nr. Ø x Länge x Spirallänge mm
Order-no. Ø x length x flute length mm

27-1201012-0	12 x 350 x 200
27-1201014-0	14 x 340 x 200
27-1201016-0	16 x 340 x 200
27-1201018-0	18 x 340 x 200
27-1201020-0	20 x 320 x 200
27-1201022-0	22 x 320 x 200
27-1201024-0	24 x 320 x 200
27-1201025-0	25 x 320 x 200
27-1202028-0	28 x 370 x 250
27-1202030-0	30 x 370 x 250
27-1202032-0	32 x 370 x 250

Bestell-Nr.
Order-no.

Ø x Länge x Spirallänge mm
Ø x length x flute length mm

27-1202035-0	35 x 370 x 250
27-1202038-0	38 x 370 x 250
27-1202040-0	40 x 370 x 250
27-1203014-0	14 x 540 x 400
27-1203016-0	16 x 540 x 400
27-1203018-0	18 x 540 x 400
27-1203020-0	20 x 520 x 400
27-1203022-0	22 x 520 x 400
27-1203024-0	24 x 540 x 400
27-1203025-0	25 x 520 x 400
27-1204028-0	28 x 570 x 450
27-1204030-0	30 x 570 x 450
27-1204032-0	32 x 570 x 450
27-1204035-0	35 x 570 x 450
27-1204038-0	38 x 570 x 450
27-1204040-0	40 x 570 x 450

Hammerbohrer

- für SDS-MAX-Aufnahme
- HM 4-Schneider
- kugelgestrahlt
- am Klipp

Hammer drill

- for SDS-MAX shank
- 4 cutter
- shot blasted
- on clip

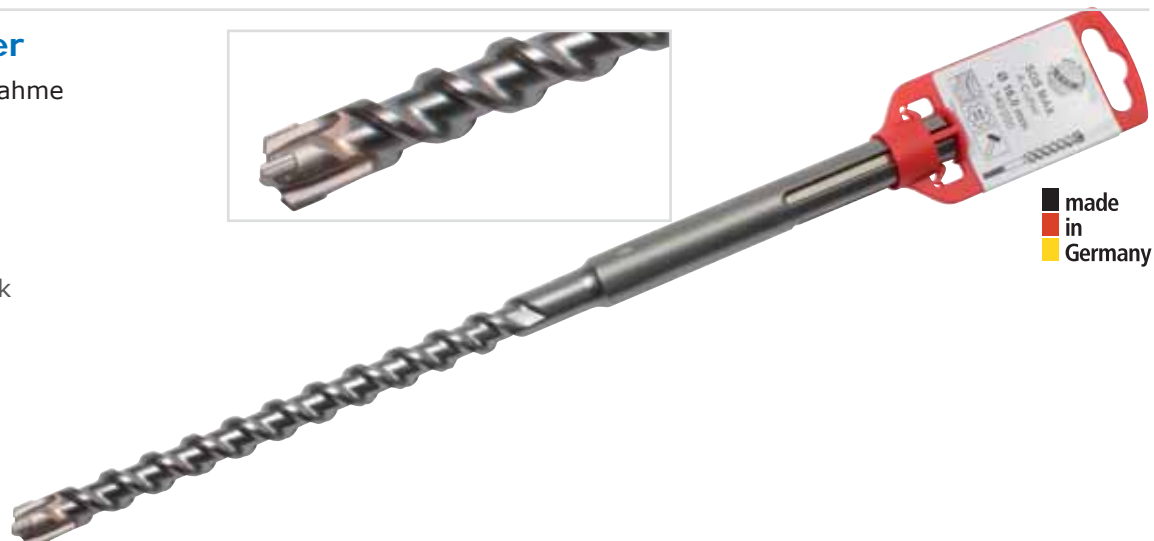

made
in
Germany

Bestell-Nr. Ø x Länge x Spirallänge mm
Order-no. Ø x length x flute length mm

27-1210161-0	16 x 340 x 200
27-1210181-0	18 x 340 x 200
27-1210201-0	20 x 320 x 200
27-1210221-0	22 x 320 x 200
27-1210241-0	24 x 320 x 200
27-1210251-0	25 x 320 x 200

Bestell-Nr.
Order-no.

Ø x Länge x Spirallänge mm
Ø x length x flute length mm

27-1210163-0	16 x 540 x 400
27-1210183-0	18 x 540 x 400
27-1210203-0	20 x 520 x 400
27-1210223-0	22 x 520 x 400
27-1210243-0	24 x 520 x 400
27-1210253-0	25 x 520 x 400
27-1210263-0	26 x 520 x 400

Hammer-Flachmeißel

- für SDS-MAX-Aufnahme
- am Klipp

Hammer flat chisel

- for SDS-MAX shank
- on clip



made
in
Germany

Bestell-Nr. Order-no.	Länge x Klingbreite mm Length x blade width mm
27-122028-0	280 x 25
27-122040-0	400 x 25
27-122060-0	600 x 25

Hammer-Hohlmeißel

- für SDS-MAX-Aufnahme
- leicht gebogen
- am Klipp

Hammer gouge

- for SDS-MAX shank
- slightly bent
- on clip



made
in
Germany

Bestell-Nr. Order-no.	Länge x Klingbreite mm mm
27-122430-0	300 x 26

Hammer-Spatmeißel

- für SDS-MAX-Aufnahme
- am Klipp

Hammer spade chisel

- for SDS-MAX shank
- on clip



made
in
Germany

Bestell-Nr. Order-no.	Länge x Klingbreite mm Length x blade width mm
27-122130-0	300 x 80
27-122140-0	400 x 50

Hammer-Spitzmeißel

- für SDS-MAX-Aufnahme
- am Klipp

Hammer pointed chisel

- for SDS-MAX shank
- on clip



made
in
Germany

Bestell-Nr. Order-no.	Länge x Ø mm Length x Ø mm
27-123028-0	280 x 18
27-123040-0	400 x 18
27-123060-0	600 x 18

Schlagbohrer RUBIN

- geeignet für
Granit
Kunststein
Marmor
Beton
- in Tasche

Hammer drill RUBIN

- useable for
beton
granite
marble
- in wallet

made
in
Germany



Bestell-Nr. Order-no.	Ø mm - Zoll Ø mm - inch	Länge mm length mm
27-124003-0	3,0-1/8	61
27-124004-0	4,0-5/32	76
27-124005-0	5,0-3/16	84
27-124006-0	6,0-15/64	100
27-124007-0	7,0-9/32	100
27-124008-0	8,0-5/16	120
27-124009-0	9,0-11/32	120
27-124010-0	10,0-3/8	120
27-124012-0	12,0-15/32	150
27-124013-0	13,0-1/2	150
27-124014-0	14,0-9/16	150
27-124016-0	16,0-5/8	150

Schlagbohrer SAPHIR

- geeignet für
Beton
Naturstein
Kunststeinl
- in Tasche

Hammer drill SAPHIR

- useable for
beton
concrete
natural stone
- in wallet

made
in
Germany



Bestell-Nr. Order-no.	Ø mm - Zoll Ø mm - inch	Länge mm length mm
27-125003-0	3,0-1/8	61
27-125004-0	4,0-5/32	76
27-125005-0	5,0-3/16	84
27-125055-0	5,5-7/32	85
27-125006-0	6,0-15/64	100
27-125065-0	6,5-1/4	100
27-125007-0	7,0-9/32	120
27-125008-0	8,0-5/16	120
27-125009-0	9,0-11/32	120
27-125010-0	10,0-3/8	120
27-125012-0	12,0-15/32	150
27-125013-0	13,0-1/2	150
27-125014-0	14,0-9/16	150
27-125016-0	16,0-5/8	150

**HSS-Spiralbohrer
DIN 338N**

- zylindrisch-kurz
- 118° rechts
- rollgewalzt

**HSS twist drill
DIN 338N**

- cylindrical, short
- 118° right
- black finish rolled

made
in
Germany



Bestell-Nr. Order-no.	Ø mm Ø mm
27-1300005-0	0,5
27-1300006-0	0,6
27-1300007-0	0,7
27-1300008-0	0,8
27-1300009-0	0,9
27-1300010-0	1,0
27-1300015-0	1,5
27-1300020-0	2,0
27-1300025-0	2,5
27-1300030-0	3,0
27-1300032-0	3,2
27-1300033-0	3,3
27-1300035-0	3,5
27-1300040-0	4,0
27-1300042-0	4,2
27-1300045-0	4,5
27-1300048-0	4,8
27-1300050-0	5,0
27-1300055-0	5,5
27-1300060-0	6,0
27-1300065-0	6,5
27-1300070-0	7,0
27-1300075-0	7,5
27-1300080-0	8,0

Bestell-Nr. Order-no.	Ø mm Ø mm
27-1300085-0	8,5
27-1300090-0	9,0
27-1300095-0	9,5
27-1300100-0	10,0
27-1300105-0	10,5
27-1300110-0	11,0
27-1300115-0	11,5
27-1300120-0	12,0
27-1300125-0	12,5
27-1300130-0	13,0
27-1300135-0	13,5
27-1300140-0	14,0
27-1300145-0	14,5
27-1300150-0	15,0
27-1300155-0	15,5
27-1300160-0	16,0
27-1300165-0	16,5
27-1300170-0	17,0
27-1300175-0	17,5
27-1300180-0	18,0
27-1300185-0	18,5
27-1300190-0	19,0
27-1300195-0	19,5
27-1300200-0	20,0

Bestell-Nr. Order-no.	Ø Zoll Ø inch
27-1301012-0	1/2
27-1301014-0	1/4
27-1301018-0	1/8
27-1301038-0	3/8
27-1301132-0	11/32
27-1301116-0	1/16
27-13011164-0	11/64
27-1301132-0	1/32
27-13011332-0	13/32
27-13011364-0	13/64
27-13011532-0	15/32
27-13011564-0	15/64
27-1301164-0	1/64
27-13011732-0	17/32
27-13011764-0	17/64
27-13011932-0	19/32
27-13011964-0	19/64
27-13012164-0	21/64
27-13012364-0	23/64

Bestell-Nr. Order-no.	Ø Zoll Ø inch
27-13012564-0	25/64
27-13012764-0	27/64
27-13012964-0	29/64
27-1301316-0	3/16
27-13013164-0	31/64
27-13013264-0	32/64
27-1301332-0	3/32
27-13013564-0	35/64
27-1301364-0	3/64
27-13013764-0	37/64
27-1301516-0	5/16
27-1301532-0	5/32
27-1301564-0	5/64
27-1301716-0	7/16
27-1301732-0	7/32
27-1301764-0	7/64
27-1301916-0	9/16
27-1301932-0	9/32
27-1301964-0	9/64



**HSS-Spiralbohrer
DIN 338N in Tasche**

- zylindrisch-kurz
- 118° rechts
- rollgewalzt

**HSS twist drill
DIN 338N in wallet**

- cylindrical, short
- 118° right
- black finish rolled



Bestell-Nr. Order-no.	Ø mm Ø mm	Satz per Stück Set of pieces
27-1310010-0	1,0	3
27-1310015-0	1,5	3
27-1310020-0	2,0	3
27-1310025-0	2,5	3
27-1310030-0	3,0	3
27-1310032-0	3,2	3
27-1310033-0	3,3	3
27-1310035-0	3,5	2
27-1310040-0	4,0	2
27-1310042-0	4,2	2
27-1310045-0	4,5	2
27-1310050-0	5,0	2
27-1310055-0	5,5	2
27-1310060-0	6,0	2
27-1310065-0	6,5	1
27-1310070-0	7,0	1
27-1310075-0	7,5	1
27-1310080-0	8,0	1
27-1310085-0	8,5	1
27-1310090-0	9,0	1
27-1310095-0	9,5	1
27-1310100-0	10,0	1
27-1310105-0	10,5	1
27-1310110-0	11,0	1
27-1310115-0	11,5	1
27-1310120-0	12,0	1
27-1310125-0	12,5	1
27-1310130-0	13,0	1

HSS-Spiralbohrer-Satz DIN 338N

- zylindrisch-kurz
- 118° rechts
- rollgewalzt
- in Metallkassette

HSS twist drill set DIN 338N

- cylindrical, short
- 118° right
- black finish rolled
- in metal box



Bestell-Nr. Order-no.	Ø mm Ø mm	Teile Pieces
27-132010-0	1-10	19
27-132013-0	1-13	25



**HSS-Spiralbohrer-Satz
DIN 338N**

- zylindrisch-kurz
- 118° rechts
- rollgewalzt
- in Plastikkassette

**HSS twist drill set
DIN 338N**

- cylindrical, short
- 118° right hand
- rolled
- in plastic box



made in Germany

Bestell-Nr. Order-no.	Ø mm Ø mm	Teile Pieces
27-133010-0	1-10	10
27-133013-0	1,5-6,5	13
27-133008-0	2-8	13
27-133019-0	1-10	19

**HSS-Spiralbohrer-Satz
DIN 338N**

- zylindrisch-kurz
- 118° rechts
- rollgewalzt
- in ROSE Kunststoffkassette

**HSS twist drill set
DIN 338N**

- cylindrical, short
- 118° right
- rolled
- in ROSE plastic box



made in Germany

Bestell-Nr. Order-no.	Ø mm Ø mm	Teile Pieces
27-132519-0	1-10	19
27-132525-0	1-13	25

HSS-Spiralbohrer DIN 338N

- zylindrisch-kurz
- 118° rechts
- rollgewalzt
- Schaft auf 13 mm reduziert

HSS twist drill DIN 338N

- cylindrical, short
- 118° right hand
- rolled
- reduced shank to 13 mm



made in Germany

Bestell-Nr. Order-no.	Ø Ø	Bestell-Nr. Order-no.	Ø Ø
27-1340135-0	13,5 mm	27-1340200-0	20,0 mm
27-1340140-0	14,0 mm	27-1340210-0	21,0 mm
27-1340145-0	14,5 mm	27-1340220-0	22,0 mm
27-1340150-0	15,0 mm	27-1340230-0	23,0 mm
27-1340155-0	15,5 mm	27-1340240-0	24,0 mm
27-1340160-0	16,0 mm	27-1340250-0	25,0 mm
27-1340165-0	16,5 mm	27-1340916-0	9/16"
27-1340170-0	17,0 mm	27-1340058-0	5/8"
27-1340175-0	17,5 mm	27-1340034-0	3/4"
27-1340180-0	18,0 mm	27-13401116-0	11/16"
27-1340185-0	18,5 mm	27-1340078-0	7/8"
27-1340190-0	19,0 mm	27-1340001-0	1"
27-1340195-0	19,5 mm		

HSS-Spiralbohrer DIN 345N

- 118° rechts
- mit Morsekegel
- rollgewalzt

HSS twist drill DIN 345N

- 118° right hand
- with morse taper shank
- rolled



made
in
Germany

Bestell-Nr. Order-no.	Ø mm Ø mm
27-1500100-0	10,0
27-1500105-0	10,5
27-1500110-0	11,0
27-1500115-0	11,5
27-1500120-0	12,0
27-1500125-0	12,5
27-1500130-0	13,0
27-1500135-0	13,5
27-1500140-0	14,0
27-1500145-0	14,5
27-1500150-0	15,0
27-1500155-0	15,5
27-1500160-0	16,0
27-1500165-0	16,5
27-1500170-0	17,0
27-1500175-0	17,5
27-1500180-0	18,0
27-1500185-0	18,5
27-1500190-0	19,0
27-1500195-0	19,5
27-1500200-0	20,0
27-1500205-0	20,5
27-1500210-0	21,0
27-1500215-0	21,5
27-1500220-0	22,0
27-1500225-0	22,5
27-1500230-0	23,0
27-1500235-0	23,5
27-1500240-0	24,0

Bestell-Nr. Order-no.	Ø mm Ø mm
27-1500245-0	24,5
27-1500250-0	25,0
27-1500255-0	25,5
27-1500260-0	26,0
27-1500265-0	26,5
27-1500270-0	27,0
27-1500275-0	27,5
27-1500280-0	28,0
27-1500285-0	28,5
27-1500290-0	29,0
27-1500295-0	29,5
27-1500300-0	30,0
27-1500305-0	30,5
27-1500310-0	31,0
27-1500315-0	31,5
27-1500320-0	32,0
27-1500325-0	32,5
27-1500330-0	33,0
27-1500335-0	33,5
27-1500340-0	34,0
27-1500345-0	34,5
27-1500350-0	35,0
27-1500400-0	40,0
27-1500450-0	45,0
27-1500500-0	50,0
27-1500550-0	55,0
27-1500600-0	60,0
27-1500650-0	65,0

HSS-Spiralbohrer DIN 338N

- zylindrisch-kurz
- 135° rechts
- geschliffen/blank

HSS twist drill DIN 338N

- cylindrical, short
- 135° right hand
- all ground



made
in
Germany

Bestell-Nr. Order-no.	Ø mm Ø mm
27-1360010-0	1,0
27-1360015-0	1,5
27-1360020-0	2,0
27-1360025-0	2,5
27-1360030-0	3,0
27-1360033-0	3,3
27-1360035-0	3,5
27-1360040-0	4,0
27-1360042-0	4,2
27-1360045-0	4,5
27-1360050-0	5,0
27-1360055-0	5,5
27-1360060-0	6,0
27-1360065-0	6,5
27-1360070-0	7,0
27-1360075-0	7,5
27-1360080-0	8,0

Bestell-Nr. Order-no.	Ø mm Ø mm
27-1360085-0	8,5
27-1360090-0	9,0
27-1360095-0	9,5
27-1360100-0	10,0
27-1360105-0	10,5
27-1360110-0	11,0
27-1360115-0	11,5
27-1360120-0	12,0
27-1360125-0	12,5
27-1360130-0	13,0
27-1360135-0	13,5
27-1360140-0	14,0
27-1360145-0	14,5
27-1360150-0	15,0
27-1360155-0	15,5
27-1360160-0	16,0

**HSS-Spiralbohrer-Satz
DIN 338N**

- zylindrisch-kurz
- 135° rechts
- geschliffen/blank
- in Metallkassette

**HSS twist drill set
DIN 338N**

- cylindrical, short
- 135° right hand
- all ground
- in metal box



made in Germany

Bestell-Nr. Order-no.	Ø mm Ø mm	Teile Pieces
27-137010-0	1 - 10	19
27-137013-0	1 - 13	25

**HSS-Spiralbohrer Co 5%
DIN 338N**

- zylindrisch-kurz
- 135° rechts
- goldfarbig

**HSS twist drill Co 5%
DIN 338N**

- cylindrical, short
- 135° right hand
- gold finish



made in Germany

Bestell-Nr. Order-no.	Ø mm Ø mm	Bestell-Nr. Order-no.	Ø mm Ø mm
27-1450010-0	1,0	27-1450075-0	7,5
27-1450015-0	1,5	27-1450080-0	8,0
27-1450020-0	2,0	27-1450085-0	8,5
27-1450025-0	2,5	27-1450090-0	9,0
27-1450030-0	3,0	27-1450095-0	9,5
27-1450035-0	3,5	27-1450100-0	10,0
27-1450040-0	4,0	27-1450105-0	10,5
27-1450045-0	4,5	27-1450110-0	11,0
27-1450050-0	5,0	27-1450115-0	11,5
27-1450055-0	5,5	27-1450120-0	12,0
27-1450060-0	6,0	27-1450125-0	12,5
27-1450065-0	6,5	27-1450130-0	13,0
27-1450070-0	7,0		



**HSS-Spiralbohrer-Satz
Co 5% DIN 338N**

- zylindrisch-kurz
- 135° rechts
- goldfarbig
- in ROSE box

**HSS twist drill set
Co 5% DIN 338N**

- cylindrical, short
- 135° right hand
- gold finish
- in ROSE box



made in Germany

Bestell-Nr. Order-no.	Ø mm Ø mm	Teile Pieces
27-146019-0	1 - 10	19
27-146025-0	1 - 13	25

**HSS-Spiralbohrer
Co 5% DIN 338N**

- zylindrisch-kurz
- 135° rechts
- goldfarbig
- Schaft abgedreht auf 13 mm

**HSS twist drill
Co 5% DIN 338N**

- cylindrical, short
- 135° right hand
- gold finish
- reduced shank to 13 mm



made in Germany

Bestell-Nr. Order-no.	Ø mm Ø mm	Bestell-Nr. Order-no.	Ø mm Ø mm
27-1480135-0	13,5	27-1480170-0	17,0
27-1480140-0	14,0	27-1480175-0	17,5
27-1480145-0	14,5	27-1480180-0	18,0
27-1480150-0	15,0	27-1480185-0	18,5
27-1480155-0	15,5	27-1480190-0	19,0
27-1480160-0	16,0	27-1480195-0	19,5
27-1480165-0	16,5	27-1480200-0	20,0

**Holzspiralbohrer
Form B**

- aus Chrom-Vanadium
- mit Zentrierspitze
- in Tasche

**Wood working drill
form B**

- Chrom-Vanadium
- with center point
- in wallet



MADE IN EU

Bestell-Nr. Order-no.	Ø mm Ø mm
27-152003-0	3,0
27-152004-0	4,0
27-152005-0	5,0
27-152006-0	6,0
27-152007-0	7,0
27-152008-0	8,0
27-152009-0	9,0
27-152010-0	10,0
27-152011-0	11,0

Bestell-Nr. Order-no.	Ø mm Ø mm
27-152012-0	12,0
27-152013-0	13,0
27-152014-0	14,0
27-152015-0	15,0
27-152016-0	16,0
27-152017-0	17,0
27-152018-0	18,0
27-152020-0	20,0

Schalungsbohrer

- zylindrischer-Schaft
- im Röhrchen mit Aufhängeloch
- Chrom-Vanadium

Frame wood drill

- cylindrical-shank
- in tube with hanger
- Chrom-Vanadium



made in Germany

Bestell-Nr. Order-no.	Ø x Länge mm Ø x length mm	Bestell-Nr. Order-no.	Ø x Länge mm Ø x length mm
27-155006-0	6 x 400	27-156006-0	6 x 600
27-155008-0	8 x 400	27-156008-0	8 x 600
27-155010-0	10 x 400	27-156010-0	10 x 600
27-155012-0	12 x 400	27-156012-0	12 x 600
27-155014-0	14 x 400	27-156014-0	14 x 600
27-155016-0	16 x 400	27-156016-0	16 x 600
27-155018-0	18 x 400	27-156018-0	18 x 600
27-155020-0	20 x 400	27-156020-0	20 x 600
27-155022-0	22 x 400	27-156022-0	22 x 600
27-155024-0	24 x 400	27-156024-0	24 x 600
27-155026-0	26 x 400	27-156026-0	26 x 600
27-155028-0	28 x 400	27-156028-0	28 x 600
27-155030-0	30 x 400	27-156030-0	30 x 600

Maschinen-Langlochbohrer

- rechts schneidend
- mit Spanbrecher
- zweischneidig
- 50 x 16 mm

Machine mortise bits

- right hand cutting
- with chip breaker
- with 2 cutters
- 50 x 16 mm



MADE IN EU

Bestell-Nr. Order-no.	Ø mm Ø mm	Bestell-Nr. Order-no.	Ø mm Ø mm
27-157006-0	6,0	27-157016-0	16,0
27-157007-0	7,0	27-157017-0	17,0
27-157008-0	8,0	27-157018-0	18,0
27-157009-0	9,0	27-157019-0	19,0
27-157010-0	10,0	27-157020-0	20,0
27-157011-0	11,0	27-157022-0	22,0
27-157012-0	12,0	27-157024-0	24,0
27-157013-0	13,0	27-157026-0	26,0
27-157014-0	14,0	27-157028-0	28,0
27-157015-0	15,0	27-157030-0	30,0

Maschinen-Langlochbohrer

- rechts schneidend
- mit Spanbrecher
- zweischneidig
- 50 x 13 mm

Machine mortise bits

- right hand cutting
- with chip breaker
- with 2 cutters
- 50 x 13 mm



MADE IN EU

Bestell-Nr. Order-no.	Ø mm Ø mm	Bestell-Nr. Order-no.	Ø mm Ø mm
27-158006-0	6,0	27-158016-0	16,0
27-158007-0	7,0	27-158017-0	17,0
27-158008-0	8,0	27-158018-0	18,0
27-158009-0	9,0	27-158019-0	19,0
27-158010-0	10,0	27-158020-0	20,0
27-158011-0	11,0	27-158022-0	22,0
27-158012-0	12,0	27-158024-0	24,0
27-158013-0	13,0	27-158026-0	26,0
27-158014-0	14,0	27-158028-0	28,0
27-158015-0	15,0	27-158030-0	30,0



Zentriermbohrer

- mit rundem Schaft
- polierte Ausführung
- im Röhrchen mit Aufhängeloch

**Centre bit**

- with round shank
- polished
- cylindrical-shank
- in tube with hanger



made
in
Germany

Bestell-Nr.	Ø mm
Order-no.	Ø mm
27-160013-0	13-45
27-160022-0	23-75

WIDIA Scharnierlochbohrer

- mit Zentrierspitze und eingelöteter HM-Platte
- im Röhrchen mit Aufhängeloch

WIDIA hinge hole cutter

- with center point and soldered HM plate
- cylindrical-shank
- in tube with hanger

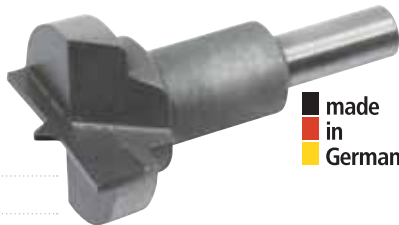

made
in
Germany

Bestell-Nr.	Ø mm
Order-no.	Ø mm
27-167026-0	26,0
27-167030-0	30,0
27-167035-0	35,0

WS-Scharnierlochbohrer

- für Weichholz
- schwarz
- im Röhrchen mit Aufhängeloch

WS hinge hole cutter

- for soft wood
- black
- cylindrical-shank
- in tube with hanger

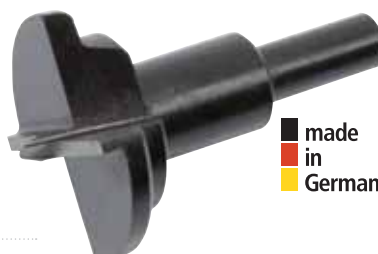

made
in
Germany

Bestell-Nr.	Ø mm
Order-no.	Ø mm
27-168026-0	26,0
27-168030-0	30,0
27-168035-0	35,0

WS-Senker 90°

- für Holz
- brüniert
- mit rundem Schaft
- mit fünf Schneiden
- in Tasche

WS countersink drill 90°

- for wood
- black finish
- round shank
- mit five cutting edges
- in wallet



made
in
Germany

Bestell-Nr.	Ø mm
Order-no.	Ø mm

27-170010-0 10,0

27-170012-0 12,0

27-170016-0 16,0

WS-Senker 90°

- für Holz
- brüniert
- mit 6-kant Schaft 1/4"
- mit sieben Schneiden
- in Tasche

WS countersink drill 90°

- for wood
- black finish
- hexagonal shank 1/4"
- mit seven cutting edges
- in wallet



made
in
Germany

Bestell-Nr.	Ø mm
Order-no.	Ø mm

27-170110-0 10,0

27-170113-0 13,0

Bestell-Nr.	Ø mm
Order-no.	Ø mm

27-170116-0 16,0

Handsenker

- für Holz
- brüniert
- mit Plastikgriff

Countersink drill

- for wood
- black finish
- with plastic handle



made in Germany

Bestell-Nr.	Ø mm
Order-no.	Ø mm
27-171012-0	12,0

Aufstecksenker 90°

- für Holz
- Ø 12 mm
- mit fünf Schneiden

Shell drill 90°

- for wood
- Ø 12 mm
- with five cutters



made in Germany

Bestell-Nr.	Ø mm	Bestell-Nr.	Ø mm
Order-no.	Ø mm	Order-no.	Ø mm
27-173003-0	3,0	27-173005-0	5,0
27-173004-0	4,0	27-173006-0	6,0

Aufstecksenkersatz 90° für Holz

- fünf Schneiden
- mit Bohrer und Stiftschlüssel
- zylindrischer Schaft
- im Röhrchen mit Aufhängeloch

Shell drill set 90° for wood

- with five cutters
- with drill and key
- cylindrical-shank
- in tube with hanger



made in Germany

Bestell-Nr.	Bohrer Ø mm	Senker Ø mm
Order-no.	Drill Ø mm	Shell drill Ø mm
27-174003-0	3,0	10,0
27-174004-0	4,0	12,0
27-174005-0	5,0	13,0
27-174006-0	6,0	13,0

Nagelbohrer

- lackiert
- Spitze poliert

Gimlet

- japanned
- point polished

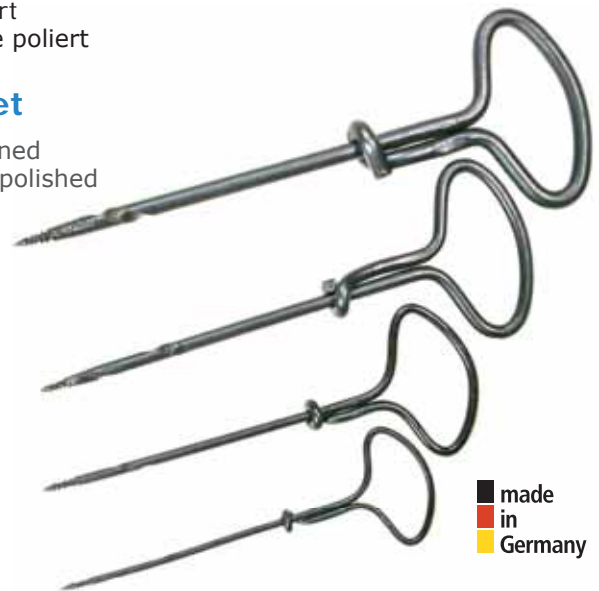

made in Germany

Bestell-Nr.	Ø mm	Bestell-Nr.	Ø mm
Order-no.	Ø mm	Order-no.	Ø mm
27-180002-0	2,0	27-180005-0	5,0
27-180003-0	3,0	27-180006-0	6,0
27-180004-0	4,0		



Glasbohrer

- mit geschliffener Hartmetallplatte
- galvanisiert
- zum Bohren in Spiegelglas
Glasscheiben
Porzellan etc.
- in Tasche

Glass drill

- with carbide tip
- galvanized
- for drilling in
plate glass
glass panes
bottle glass etc.
- in wallet

made
in
Germany



Bestell-Nr. Order-no.	Ø mm Ø mm
27-127003-0	3,0
27-127004-0	4,0
27-127005-0	5,0
27-127006-0	6,0
27-127008-0	8,0
27-127010-0	10,0
27-127012-0	12,0

Schraubenausdrehersatz

in Kassette

Screw extractor set

in box

made
in
Germany



Bestell-Nr. Order-no.	Teile Pieces	für Schrauben for screws
27-183005-0	5	M 3-18
27-183006-0	6	M 3-24
27-183008-0	8	M 3-50

Schraubenausdreher**Screw extractor**

made
in
Germany

Bestell-Nr. Order-no.	Größe size	für Schrauben for screws
27-182001-0	1	M 3-6
27-182002-0	2	M 6-8
27-182003-0	3	M 8-11
27-182004-0	4	M 11-14
27-182005-0	5	M 14-18
27-182006-0	6	M 18-24
27-182007-0	7	M 24-33
27-182008-0	8	M 33-50

Düsenreibahlen

- mit Halter
- 12 teilig
- im Plastiksetui

**Nozzle reamer
set**

- with holder
- set of 12 pieces
- in plastic box



made
in
Germany

Bestell-Nr. Order-no.	für Düsen Ø mm for nozzles Ø mm
27-185012-0	0,6-1,9

Aluminium-Einzahnfräser

- aus HSS-E
- in Plastikdose

Aluminium single flute cutter

- made of HSS-E
- in single box



made
in
Germany

Bestell-Nr. Order-no.	Ø x Spirallänge mm Ø x flute length mm	Gesamtlänge x Schaft Ø mm Total length x shank Ø	Bestell-Nr. Order-no.	Ø x Spirallänge mm Ø x flute length mm	Gesamtlänge x Schaft Ø mm Total length x shank Ø
27-189005-0	5 x 12	60 x 8	27-189204-0	4 x 12	60 x 6,35-1/4"
27-189006-0	6 x 14	60 x 8	27-189205-0	5 x 12	60 x 6,35-1/4"
27-189008-0	8 x 14	80 x 8	27-189206-0	6 x 12	60 x 6,35-1/4"
27-189104-0	4 x 12	60 x 6	27-189207-0	7 x 12	60 x 6,35-1/4"
27-189105-0	5 x 12	60 x 6	27-189208-0	8 x 12	60 x 6,35-1/4"
27-189106-0	6 x 14	60 x 6	27-189303-0	5 x 14	100 x 8
27-189108-0	8 x 14	60 x 6	27-189304-0	6 x 14	100 x 8
27-189109-0	8 x 14/68	100 x 8	27-189305-0	5 x 18	60 x 8
			27-189404-0	4 x 16/45	90 x 8
			27-189405-0	5 x 16/45	90 x 8
			27-189406-0	6 x 16/45	90 x 8
			27-189505-0	5 x 18/35	100 x 8



Brustbohrmaschine

- schwere Ausführung
- mit Brustplatte
- mit Kurbel und Seitengriff

Breast drill

- heavy duty model
- with breast plate
- with detachable crank and side handle



made
in
Germany

Bestell-Nr.
Order-no.

27-205013-0

Spannend Ø mm
Range Ø mm

0 - 13

Handdrillbohrer

mit einem Ritzel und Kurbel

Hand drill

with one pinion and
hand crank



made
in
Germany

Bestell-Nr.
Order-no.

27-207008-0

Spannend Ø mm
Range Ø mm

0-8

Steinbohrer ISO 5468

- mit Hartmetallschneide
- sandgestrahlt
- in Tasche

**Masonry drill
ISO 5468**

- with hard metal edge
- sand blasted
- in wallet



Bestell-Nr. Order-no.	Ø mm - Zoll Ø mm - inch	Länge mm length mm
27-101003-9	3,0-1/8	61
27-101004-9	4,0-5/32	76
27-101005-9	5,0-3/16	84
27-101055-9	5,5-7/32	84
27-101006-9	6,0-15/64	100
27-101065-9	6,5-1/4	100
27-101007-9	7,0-9/32	110
27-101008-9	8,0-5/16	115
27-101009-9	9,0-11/32	125
27-101010-9	10,0-3/8	125
27-101011-9	11,0-7/16	140
27-101012-9	12,0-15/32	140
27-101013-9	13,0-1/2	150
27-101014-9	14,0-9/16	150
27-101015-9	15,0-19/32	150
27-101016-9	16,0-5/8	160
27-101018-9	18,0-23/32	160
27-101020-9	20,0-3/4	160
27-101022-9	22,0-7/8	160
27-101024-9	24,0-15/16	160
27-101025-9	25,0-1	160

Bestell-Nr. Order-no.	Ø mm - Zoll Ø mm - inch	Länge mm length mm
27-1030052-9	5,0-3/16	200
27-1030062-9	6,0-15/64	200
27-1030652-9	6,5-1/4	200
27-1030082-9	8,0-5/16	200
27-1030102-9	10,0-3/8	200
27-1030122-9	12,0-15/32	200
27-1030132-9	13,0-1/2	200
27-1030142-9	14,0-9/16	200
27-1030162-9	16,0-5/8	200
27-1030064-9	6,0-15/64	400
27-1030654-9	6,5-1/4	400
27-1030084-9	8,0-5/16	400
27-1030104-9	10,0-3/8	400
27-1030124-9	12,0-15/32	400
27-1030134-9	13,0-1/2	400
27-1030144-9	14,0-9/16	400
27-1030164-9	16,0-5/8	400
27-1030184-9	18,0-23/32	400
27-1030204-9	20,0-3/4	400
27-1030224-9	22,0-7/8	400
27-1030244-9	24,0-15/16	400
27-1030254-9	25,0-1	400
27-1030264-9	26,0	400
27-1030284-9	28,0	400
27-1030304-9	30,0	400
27-1030324-9	32,0	400
27-107008-9	8,0-5/16	600
27-107010-9	10,0-3/8	600
27-107012-9	12,0-15/32	600
27-107013-9	13-0-1/2	600
27-107014-9	14,0-9/16	600
27-107016-9	16,0-5/8	600
27-107018-9	18,0-23/32	600
27-107020-9	20,0-3/4	600
27-107022-9	22,0-7/8	600
27-107024-9	24,0-15/16	600
27-107025-9	25,0-1	600
27-107026-9	26,0	600
27-107028-9	28,0	600
27-107030-9	30,0	600
27-107032-9	32,0	600

Steinbohrer-Satz ISO 5468

- mit Hartmetallschneide
- sandgestrahlt
- in Kassette

Masonry drill set ISO 5468

- with hard metal edge
- sand blasted
- in box

Bestell-Nr. Order-no.	Teile/Satz Pieces/set	Ø Bohrer mm Ø Drill mm
27-108004-9	4	4-5-6-8
27-108005-9	5	4-5-6-8-10
27-108008-9	8	3-4-5-6-7-8-9-10



Hammerbohrer

- für SDS-PLUS-Aufnahme
- mit HM-Platte
- sandgestrahlt
- am Klipp

Hammer drill

- for SDS-PLUS shank
- with HM edge
- sand blasted
- on clip



Bestell-Nr. Order-no.	Ø x Länge x Spirallänge mm Ø x length x flute length mm	Bestell-Nr. Order-no.	Ø x Länge x Spirallänge mm Ø x length x flute length mm	Bestell-Nr. Order-no.	Ø x Länge x Spirallänge mm Ø x length x flute length mm
27-1100042-9	4 x 160 x 100	27-1100103-9	10 x 210 x 150	27-1100204-9	20 x 260 x 200
27-1100052-9	5 x 160 x 100	27-1100113-9	11 x 210 x 150	27-1100214-9	21 x 260 x 200
27-1100062-9	6 x 160 x 100	27-1100123-9	12 x 210 x 150	27-1100224-9	22 x 260 x 200
27-1100072-9	7 x 160 x 100	27-1100133-9	13 x 210 x 150	27-1100234-9	23 x 260 x 200
27-1100082-9	8 x 160 x 100	27-1100143-9	14 x 210 x 150	27-1100244-9	24 x 260 x 200
27-1100092-9	9 x 160 x 100	27-1100153-9	15 x 210 x 150	27-1100254-9	25 x 260 x 200
27-1100102-9	10 x 160 x 100	27-1100163-9	16 x 210 x 150	27-1100264-9	26 x 260 x 200
27-1100112-9	11 x 160 x 100	27-1100173-9	17 x 210 x 150	27-1100284-9	28 x 260 x 200
27-1100122-9	12 x 160 x 100	27-1100183-9	18 x 210 x 150	27-1100304-9	30 x 260 x 200
27-1100132-9	13 x 160 x 100	27-1100193-9	19 x 210 x 150		
27-1100142-9	14 x 160 x 100	27-1100203-9	20 x 210 x 150	27-1100065-9	6 x 310 x 250
27-1100152-9	15 x 160 x 100	27-1100213-9	21 x 210 x 150	27-1100085-9	8 x 310 x 250
27-1100162-9	16 x 160 x 100	27-1100223-9	22 x 210 x 150	27-1100095-9	9 x 310 x 250
27-1100172-9	17 x 160 x 100	27-1100233-9	23 x 210 x 150	27-1100105-9	10 x 310 x 250
27-1100182-9	18 x 160 x 100	27-1100243-9	24 x 210 x 150	27-1100115-9	11 x 310 x 250
27-1100192-9	19 x 160 x 100	27-1100253-9	25 x 210 x 150	27-1100125-9	12 x 310 x 250
27-1100202-9	20 x 160 x 100	27-1100263-9	26 x 210 x 150	27-1100135-9	13 x 310 x 250
27-1100212-9	21 x 160 x 100	27-1100283-9	28 x 210 x 150	27-1100145-9	14 x 310 x 250
27-1100222-9	22 x 160 x 100	27-1100293-9	29 x 210 x 150	27-1100155-9	15 x 310 x 250
27-1100232-9	23 x 160 x 100	27-1100303-9	30 x 210 x 150	27-1100165-9	16 x 310 x 250
27-1100242-9	24 x 160 x 100			27-1100175-9	17 x 310 x 250
27-1100252-9	25 x 160 x 100	27-1100064-9	6 x 260 x 200	27-1100185-9	18 x 310 x 250
27-1100262-9	26 x 160 x 100	27-1100084-9	8 x 260 x 200	27-1100195-9	19 x 310 x 250
27-1100272-9	27 x 160 x 100	27-1100104-9	10 x 260 x 200	27-1100205-9	20 x 310 x 250
27-1100282-9	28 x 160 x 100	27-1100114-9	11 x 260 x 200	27-1100215-9	21 x 310 x 250
27-1100292-9	29 x 160 x 100	27-1100124-9	12 x 260 x 200	27-1100225-9	22 x 310 x 250
27-1100302-9	30 x 160 x 100	27-1100134-9	13 x 260 x 200	27-1100235-9	23 x 310 x 250
		27-1100144-9	14 x 260 x 200	27-1100245-9	24 x 310 x 250
27-1100053-9	5 x 210 x 150	27-1100154-9	15 x 260 x 200	27-1100255-9	25 x 310 x 250
27-1100063-9	6 x 210 x 150	27-1100164-9	16 x 260 x 200	27-1100265-9	26 x 310 x 250
27-1100073-9	7 x 210 x 150	27-1100174-9	17 x 260 x 200	27-1100285-9	28 x 310 x 250
27-1100083-9	8 x 210 x 150	27-1100184-9	18 x 260 x 200	27-1100305-9	30 x 310 x 250
27-1100093-9	9 x 210 x 150	27-1100194-9	19 x 260 x 200		

Hammerbohrer-Satz

- für SDS-PLUS-Aufnahme
- 5-teilig
- in Kunststoffkassete

Hammer drill set

- for SDS-PLUS shank
- set of 5 pieces
- in box



Bestell-Nr. Order-no.	Ø x Gesamtlänge mm Ø x total length mm
27-112004-9	4 - 5 - 6 - 8 - 10 x 160
27-112005-9	5 - 6 - 8 x 110 / 6 - 8 x 160

**Hammerbohrer-Satz**

- für SDS-PLUS-Aufnahme
- 7-teilig
- in Metallkassette

Hammer drill set

- for SDS-PLUS shank
- 7 pieces
- in metal box



Bestell-Nr. Order-no.	Ø x Gesamtlänge mm Ø x total length mm
27-117007-9	5 - 6 - 8 x 110 / 6 - 8 - 10 - 12 x 160

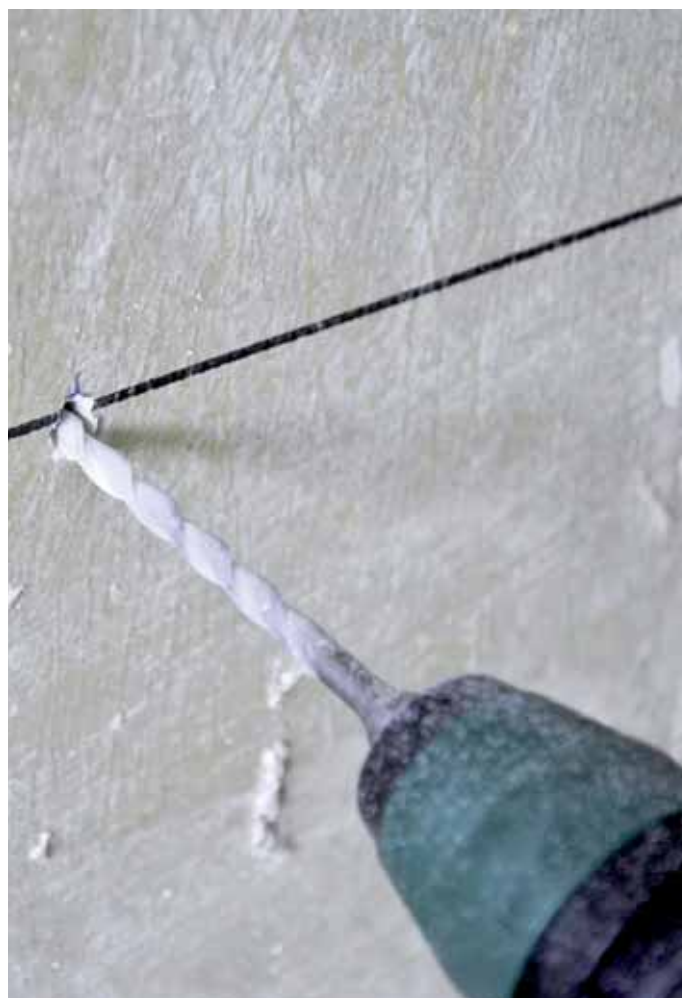

Hammerbohrer

- für SDS-PLUS-Aufnahme
- HM 4-Schneider
- kugelgestrahlt
- am Klipp

Hammer drill

- for SDS-PLUS shank
- HM 4 cutter
- shot blasted
- on clip



Bestell-Nr. Ø x Länge x Spirallänge mm
Order-no. Ø x length x flute length mm

27-1191051-9	5 x 110
27-1191061-9	6 x 110
27-1191651-9	6,5 x 110
27-1191081-9	8 x 110
27-1191101-9	10 x 110

27-1191052-9	5 x 160
27-1191062-9	6 x 160
27-1191652-9	6,5 x 160
27-1191072-9	7 x 160
27-1191082-9	8 x 160
27-1191102-9	10 x 160
27-1191122-9	12 x 160
27-1191142-9	14 x 160
27-1191152-9	15 x 160

27-1191063-9	6 x 210
27-1191653-9	6,5 x 210
27-1191083-9	8 x 210
27-1191103-9	10 x 210
27-1191123-9	12 x 210
27-1191143-9	14 x 210
27-1191163-9	16 x 210
27-1191183-9	18 x 210

27-1191064-9	6 x 260
27-1191654-9	6,5 x 260
27-1191084-9	8 x 260
27-1191104-9	10 x 260
27-1191124-9	12 x 260

Bestell-Nr. Ø x Länge x Spirallänge mm
Order-no. Ø x length x flute length mm

27-1191144-9	14 x 260
27-1191164-9	16 x 260
27-1191224-9	22 x 250
27-1191244-9	24 x 260

27-1191105-9	10 x 310
27-1191145-9	14 x 310
27-1191165-9	16 x 310
27-1191185-9	18 x 310
27-1191205-9	20 x 300
27-1191106-9	10 x 360

27-1191087-9	8 x 450
27-1191107-9	10 x 450
27-1191127-9	12 x 450
27-1191147-9	14 x 450
27-1191167-9	16 x 450
27-1191187-9	18 x 450
27-1191207-9	20 x 450
27-1191257-9	25 x 450
27-1191267-9	26 x 450

27-1191108-9	10 x 600
27-1191128-9	12 x 600
27-1191148-9	14 x 600
27-1191168-9	16 x 600
27-1191208-9	20 x 600

27-1191129-9	12 x 1.000
------------------------------	------------

Hammer-Flachmeißel

- für SDS-PLUS-Aufnahme
- am Klipp

Hammer flat chisel

- for SDS-PLUS shank
- on clip



Bestell-Nr. Order-no.	Länge x Klingenbreite mm Length x Width mm
27-114025-9	250 x 22
27-114040-9	450 x 25
27-114060-9	600 x 25

Hammer-Spitzmeißel

- für SDS-PLUS-Aufnahme
- am Klipp

Hammer pointed chisel

- for SDS-PLUS shank
- on clip



Bestell-Nr. Order-no.	Länge x Ø mm Length x Ø mm
27-115025-9	250 x 17
27-115040-9	450 x 20

Hammer-Spatmeißel

- für SDS-PLUS-Aufnahme
- am Klipp

Hammer spade chisel

- for SDS-PLUS shank
- on clip

Bestell-Nr. Order-no.	Länge x Klingenbreite mm Length x Width mm
27-114125-9	250 x 40
27-114128-9	280 x 50



Hammerbohrer

- für SDS-MAX-Aufnahme
- sandgestrahlt
- am Klipp

Hammer drill

- for SDS-MAX shank
- sand blasted
- on clip



Bestell-Nr. Order-no.	Ø x Gesamtlänge mm Ø x total length mm
27-1200121-9	12 x 320
27-1200122-9	12 x 370
27-1200123-9	12 x 600
27-1200141-9	14 x 320
27-1200142-9	14 x 370
27-1200143-9	14 x 520
27-1200144-9	14 x 600
27-1200145-9	14 x 920
27-1200161-9	16 x 320
27-1200162-9	16 x 370
27-1200163-9	16 x 520

Bestell-Nr. Order-no.	Ø x Gesamtlänge mm Ø x total length mm
27-1200164-9	16 x 600
27-1200165-9	16 x 920
27-1200181-9	18 x 320
27-1200182-9	18 x 370
27-1200183-9	18 x 520
27-1200184-9	18 x 600
27-1200185-9	18 x 920
27-1200201-9	20 x 320
27-1200202-9	20 x 370
27-1200203-9	20 x 520
27-1200204-9	20 x 600

Bestell-Nr. Order-no.	Ø x Gesamtlänge mm Ø x total length mm
27-1200205-9	20 x 920
27-1200206-9	20 x 1.320
27-1200221-9	22 x 320
27-1200222-9	22 x 370
27-1200223-9	22 x 520
27-1200224-9	22 x 600
27-1200225-9	22 x 920
27-1200251-9	25 x 320
27-1200252-9	25 x 370
27-1200253-9	25 x 520
27-1200254-9	25 x 600
27-1200255-9	25 x 920
27-1200256-9	25 x 1.320
27-1200281-9	28 x 320
27-1200282-9	28 x 370
27-1200283-9	28 x 520
27-1200284-9	28 x 600

Hammer-Flachmeißel

- für SDS-MAX-Aufnahme
- am Klipp

Hammer flat chisel

- for SDS-MAX shank
- on clip



Bestell-Nr. Order-no.	Länge x Klingenbreite mm Length x blade width mm
27-122028-9	280 x 25
27-122040-9	400 x 25
27-122060-9	600 x 25

Hammer-Spatmeißel

- für SDS-MAX-Aufnahme
- am Klipp

Hammer spade chisel

- for SDS-MAX shank
- on clip



Bestell-Nr. Order-no.	Länge x Klingenbreite mm Length x blade width mm
27-122140-9	400 x 50

Hammer-Spitzmeißel

- für SDS-MAX-Aufnahme
- am Klipp

Hammer pointed chisel

- for SDS-MAX shank
- on clip



Bestell-Nr. Order-no.	Länge x Ø mm Length x Ø mm
27-123028-9	280 x 18
27-123040-9	400 x 18
27-123060-9	600 x 18

HSS-Spiralbohrer DIN 338N

- zylindrisch-kurz
- 118° rechts
- rollgewalzt

HSS twist drill DIN 338N

- short series
- 118° right
- rolled



Bestell-Nr. Order-no.	Ø mm Ø mm	Bestell-Nr. Order-no.	Ø mm Ø mm
27-1300005-9	0,5	27-1300085-9	8.5
27-1300006-9	0,6	27-1300095-9	9.5
27-1300007-9	0,7	27-1300100-9	10.0
27-1300008-9	0,8	27-1300105-9	10.5
27-1300009-9	0,9	27-1300110-9	11.0
27-1300010-9	1,0	27-1300115-9	11.5
27-1300015-9	1,5	27-1300120-9	12.0
27-1300020-9	2,0	27-1300125-9	12.5
27-1300025-9	2,5	27-1300130-9	13.0
27-1300030-9	3,0	27-1300135-9	13.5
27-1300032-9	3,2	27-1300140-9	14.0
27-1300033-9	3,3	27-1300145-9	14.5
27-1300035-9	3,5	27-1300150-9	15.0
27-1300040-9	4,0	27-1300155-9	15.5
27-1300042-9	4,2	27-1300160-9	16,0
27-1300045-9	4,5	27-1300165-9	16.5
27-1300048-9	4,8	27-1300170-9	17.0
27-1300050-9	5,0	27-1300175-9	17.5
27-1300055-9	5,5	27-1300180-9	18.0
27-1300060-9	6,0	27-1300185-9	18.5
27-1300065-9	6,5	27-1300190-9	19.0
27-1300070-9	7,0	27-1300195-9	19.5
27-1300075-9	7,5	27-1300200-9	20.0
27-1300080-9	8,0		

HSS-Spiralbohrer-Satz DIN 338N

- zylindrisch-kurz
- 118° rechts
- rollgewalzt
- in Metallkassette

HSS twist drill set DIN 338N

- short series
- 118° right hand
- rolled
- in metal box



Bestell-Nr. Order-no.	Ø mm Ø mm	Teile Pieces
27-132010-9	1-10	19
27-132013-9	1-13	25

HSS-Spiralbohrer-Satz DIN 338N

- zylindrisch-kurz
- 118° rechts
- rollgewalzt
- in ROSE Kassette

HS twist drill set DIN 338N

- short series
- 118° right hand
- rolled
- in ROSE box

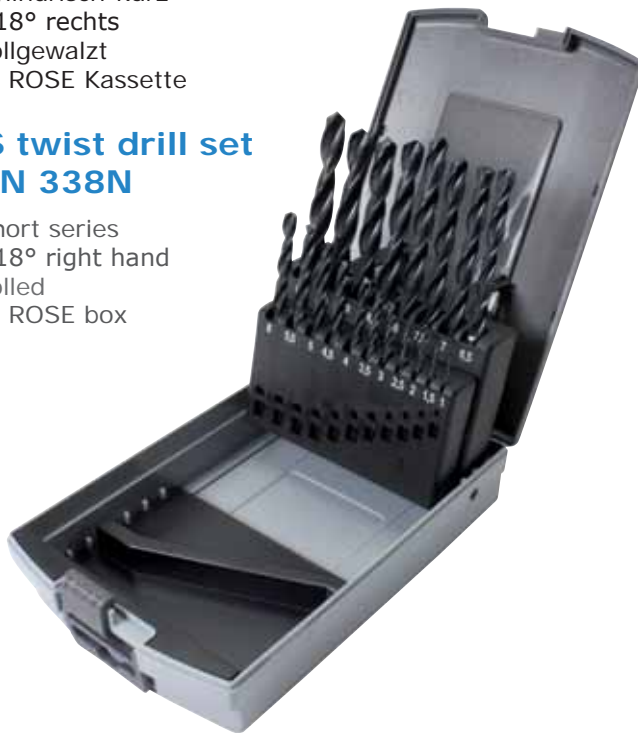

Bestell-Nr. Order-no.	Ø mm Ø mm	Teile Pieces
27-132519-9	1-10	19
27-132525-9	1-13	25

HSS-Spiralbohrer-Satz DIN 338N

- zylindrisch-kurz
- 118° rechts
- rollgewalzt
- in Plastikkassette

HSS twist drill set DIN 338N

- short series
- 118° right hand
- rolled
- in plastic box



Bestell-Nr. Order-no.	Ø mm Ø mm	Teile Pieces
27-133007-9	1,5-6,0	7
27-133013-9	1,5-6,5	13
27-133028-9	2,0-8,0	13
27-133019-9	1,0-10,0	19

HSS-Spiralbohrer DIN 340N

- zylindrisch-lang
- 118° rechts
- rollgewalzt

HSS twist drill DIN 340N

- long series
- 118° right hand
- rolled

Bestell-Nr. Order-no.	Ø mm Ø mm
27-1400020-9	2,0
27-1400025-9	2,5
27-1400030-9	3,0
27-1400035-9	3,5
27-1400040-9	4,0
27-1400045-9	4,5
27-1400050-9	5,0
27-1400055-9	5,5
27-1400060-9	6,0
27-1400065-9	6,5
27-1400070-9	7,0
27-1400075-9	7,5

Bestell-Nr. Order-no.	Ø mm Ø mm
27-1400080-9	8,0
27-1400085-9	8,5
27-1400090-9	9,0
27-1400095-9	9,5
27-1400100-9	10,0
27-1400105-9	10,5
27-1400110-9	11,0
27-1400115-9	11,5
27-1400120-9	12,0
27-1400125-9	12,5
27-1400130-9	13,0



HSS-Spiralbohrer DIN 1897N

- extra kurz
- 118° rechts
- rollgewalzt

HSS twist drill DIN 1897N

- extra short
- 118° right hand
- rolled



Bestell-Nr. Order-no.	Ø mm Ø mm
27-1410020-9	2,0
27-1410025-9	2,5
27-1410030-9	3,0
27-1410032-9	3,2
27-1410033-9	3,3

Bestell-Nr. Order-no.	Ø mm Ø mm
27-1410035-9	3,5
27-1410040-9	4,0
27-1410042-9	4,2
27-1410045-9	4,5
27-1410050-9	5,0





HSS-Spiralbohrer DIN 345N

- 118° rechts
- mit Morsekegel

HSS-Twist drill DIN 345N

- 118° right hand
- with morse taper shank



HSS-Spiralbohrer DIN 338N

- zylindrisch-kurz
- 118° rechts
- Schaft abgedreht auf 13 mm
- in Tasche

HSS twist drill DIN 338N

- short series
- 118° right hand
- reduced shank to 13 mm
- in wallet



Bestell-Nr. Order-no.	Ø mm Ø mm	Bestell-Nr. Order-no.	Ø mm Ø mm
27-1340135-9	13,5	27-1340185-9	18,5
27-1340140-9	14,0	27-1340190-9	19,0
27-1340145-9	14,5	27-1340195-9	19,5
27-1340150-9	15,0	27-1340200-9	20,0
27-1340155-9	15,5	27-1340210-9	21,0
27-1340160-9	16,0	27-1340220-9	22,0
27-1340165-9	16,5	27-1340230-9	23,0
27-1340170-9	17,0	27-1340240-9	24,0
27-1340175-9	17,5	27-1340250-9	25,0
27-1340180-9	18,0		

Bestell-Nr. Order-no.	Ø mm Ø mm	Bestell-Nr. Order-no.	Ø mm Ø mm
27-1500100-9	10,0	27-1500245-9	24,5
27-1500105-9	10,5	27-1500250-9	25,0
27-1500110-9	11,0	27-1500255-9	25,5
27-1500115-9	11,5	27-1500260-9	26,0
27-1500120-9	12,0	27-1500265-9	26,5
27-1500125-9	12,5	27-1500270-9	27,0
27-1500130-9	13,0	27-1500275-9	27,5
27-1500135-9	13,5	27-1500280-9	28,0
27-1500140-9	14,0	27-1500285-9	28,5
27-1500145-9	14,5	27-1500290-9	29,0
27-1500150-9	15,0	27-1500295-9	29,5
27-1500155-9	15,5	27-1500300-9	30,0
27-1500160-9	16,0	27-1500305-9	30,5
27-1500165-9	16,5	27-1500310-9	31,0
27-1500170-9	17,0	27-1500315-9	31,5
27-1500175-9	17,5	27-1500320-9	32,0
27-1500180-9	18,0	27-1500325-9	32,5
27-1500185-9	18,5	27-1500330-9	33,0
27-1500190-9	19,0	27-1500335-9	33,5
27-1500195-9	19,5	27-1500340-9	34,0
27-1500200-9	20,0	27-1500345-9	34,5
27-1500205-9	20,5	27-1500350-9	35,0
27-1500210-9	21,0		
27-1500215-9	21,5		
27-1500220-9	22,0		
27-1500225-9	22,5		
27-1500230-9	23,0		
27-1500235-9	23,5		
27-1500240-9	24,0		



HSS-Spiralbohrer DIN 338N

- zylindrisch-kurz
- 135° rechts
- geschliffen/blank

HSS twist drill DIN 338N

- short series
- 135° right hand
- all ground

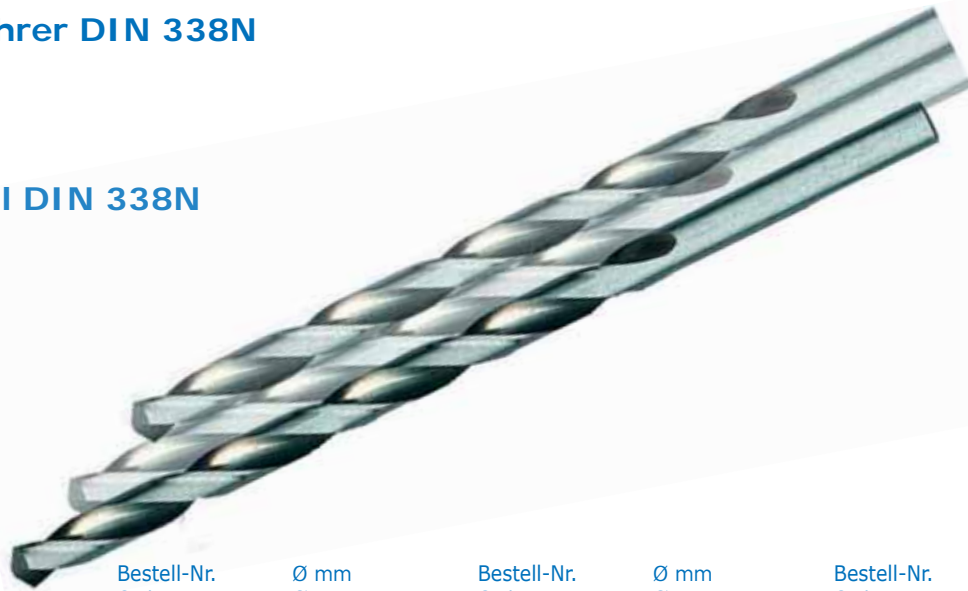

Bestell-Nr. Order-no.	Ø mm Ø mm
27-1360010-9	1,0
27-1360015-9	1,5
27-1360020-9	2,0
27-1360025-9	2,5
27-1360030-9	3,0
27-1360033-9	3,3
27-1360035-9	3,5
27-1360040-9	4,0
27-1360042-9	4,2

Bestell-Nr. Order-no.	Ø mm Ø mm
27-1360045-9	4,5
27-1360050-9	5,0
27-1360055-9	5,5
27-1360060-9	6,0
27-1360065-9	6,5
27-1360070-9	7,0
27-1360075-9	7,5
27-1360080-9	8,0
27-1360085-9	8,5

Bestell-Nr. Order-no.	Ø mm Ø mm
27-1360090-9	9,0
27-1360095-9	9,5
27-1360100-9	10,0
27-1360105-9	10,5
27-1360110-9	11,0
27-1360115-9	11,5
27-1360120-9	12,0
27-1360125-9	12,5
27-1360130-9	13,0

Bestell-Nr. Order-no.	Ø mm Ø mm
27-1360135-9	13,5
27-1360140-9	14,0
27-1360145-9	14,5
27-1360150-9	15,0
27-1360155-9	15,5
27-1360160-9	16,0

**HSS-Spiralbohrer-Satz
DIN 338N**

- zylindrisch-kurz
- 135° rechts
- geschliffen/blank
- in Metallkassette

**HSS twist drill set
DIN 338N**

- short series
- 135° right hand
- all ground
- in metal box



Bestell-Nr. Order-no.	Ø mm Ø mm	Teile Pieces
27-137010-9	1-10	19
27-137013-9	1-13	25

HSS-Spiralbohrer TIN DIN 338N

- zylindrisch-kurz
- 135° rechts

HSS twist drill TIN DIN 338N

- short series
- 135° right hand



Bestell-Nr. Order-no.	Ø mm Ø mm	Bestell-Nr. Order-no.	Ø mm Ø mm	Bestell-Nr. Order-no.	Ø mm Ø mm	Bestell-Nr. Order-no.	Ø mm Ø mm
27-1420010-9	1,0	27-1420045-9	4,5	27-1420080-9	8,0	27-1420115-9	11,5
27-1420015-9	1,5	27-1420050-9	5,0	27-1420085-9	8,5	27-1420120-9	12,0
27-1420020-9	2,0	27-1420055-9	5,5	27-1420090-9	9,0	27-1420125-9	12,5
27-1420025-9	2,5	27-1420060-9	6,0	27-1420095-9	9,5	27-1420130-9	13,0
27-1420030-9	3,0	27-1420065-9	6,5	27-1420100-9	10,0		
27-1420035-9	3,5	27-1420070-9	7,0	27-1420105-9	10,5		
27-1420040-9	4,0	27-1420075-9	7,5	27-1420110-9	11,0		

**HSS-Spiralbohrer
Co 5% DIN 338N**

- zylindrisch-kurz
- 135° rechts
- goldfarbig

**HSS twist drill
Co 5% DIN 338N**

- short series
- 135° right hand
- gold finish



Best,-Nr, Order-no,	Ø mm Ø mm	Best,-Nr, Order-no,	Ø mm Ø mm
27-1450010-9	1,0	27-1450075-9	7,5
27-1450015-9	1,5	27-1450080-9	8,0
27-1450020-9	2,0	27-1450085-9	8,5
27-1450025-9	2,5	27-1450090-9	9,0
27-1450030-9	3,0	27-1450095-9	9,5
27-1450035-9	3,5	27-1450100-9	10,0
27-1450040-9	4,0	27-1450105-9	10,5
27-1450045-9	4,5	27-1450110-9	11,0
27-1450050-9	5,0	27-1450115-9	11,5
27-1450055-9	5,5	27-1450120-9	12,0
27-1450060-9	6,0	27-1450125-9	12,5
27-1450065-9	6,5	27-1450130-9	13,0
27-1450070-9	7,0		

HSS-Spiralbohrer-Satz Co 5% DIN 338N

- zylindrisch-kurz
- 135° rechts
- goldfarbig
- in ROSE Kasette

HSS twist drill set Co 5% DIN 338N

- short series
- 135° right hand
- gold finish
- in ROSE box



Bestell-Nr. Order-no.	Ø mm Ø mm	Teile Pieces
27-146019-9	1-10	19
27-146025-9	1-13	25

**Holzspiralbohrer
Form B**

- mit Zentrierspitze
- in Tasche
- aus Chrom-Vanadium

**Wood working drill
form B**

- with center point
- in wallet
- Chrom-Vanadium



Best,-Nr, Order-no,	Ø mm Ø mm
27-152003-9	3,0
27-152004-9	4,0
27-152005-9	5,0
27-152006-9	6,0
27-152007-9	7,0
27-152008-9	8,0
27-152009-9	9,0
27-152010-9	10,0
27-152011-9	11,0
27-152012-9	12,0
27-152013-9	13,0
27-152014-9	14,0
27-152015-9	15,0
27-152016-9	16,0
27-152017-9	17,0
27-152018-9	18,0
27-152020-9	20,0

Flachfräsbohrer

- rund oder mit 6-kant Schaft
- in Einzeltasche

Flat wood working drill

- round or hexagonal shank
- in wallet



Bestell-Nr. Order-no.	Ø mm Ø mm	Bestell-Nr. Order-no.	Ø mm Ø mm
27-163006-9	6	27-163022-9	22
27-163008-9	8	27-163024-9	24
27-163010-9	10	27-163025-9	25
27-163011-9	11	27-163026-9	26
27-163012-9	12	27-163028-9	28
27-163013-9	13	27-163030-9	30
27-163014-9	14	27-163032-9	32
27-163015-9	15	27-163034-9	34
27-163016-9	16	27-163035-9	35
27-163017-9	17	27-163036-9	36
27-163018-9	18	27-163038-9	38
27-163019-9	19	27-163040-9	40
27-163020-9	20		

Forstnerbohrer BASIC

- mit Zentrierspitze und 2 Hauptschneiden
- blank
- Länge 93 mm
- im Röhrchen mit Aufhängeloch

Machine forstner drill BASIC

- with center point and 2 main cutting edges
- polished
- length 93 mm
- cylindrical-shank
- in tube with hanger



Bestell-Nr. Order-no.	Ø mm Ø mm	Bestell-Nr. Order-no.	Ø mm Ø mm
27-169010-9	10	27-169025-9	25
27-169012-9	12	27-169026-9	26
27-169014-9	14	27-169028-9	28
27-169015-9	15	27-169030-9	30
27-169016-9	16	27-169032-9	32
27-169018-9	18	27-169034-9	34
27-169020-9	20	27-169035-9	35
27-169022-9	22	27-169036-9	36
27-169023-9	23	27-169038-9	38
27-169024-9	24	27-169040-9	40

Schraubenausdreher**Screw extractor**

Bestell-Nr. Order-no.	Größe Size	für Schrauben for screws
27-182001-9	1	M 3-6
27-182002-9	2	M 6-8
27-183003-9	3	M 8-11
27-182004-9	4	M 11-14
27-182005-9	5	M 14-18
27-182006-9	6	M 18-24
27-182007-9	7	M 24-33
27-182008-9	8	M 33-50

HSS-Zentrierbohrer DIN 333A

- 60° Senkwinkel
- rechtsschneidend
- geschliffen

HSS center drill DIN 333A

- 60° angle
- right hand
- all ground



Bestell-Nr. Order-no.	Ø mm Ø mm	Bestell-Nr. Order-no.	Ø mm Ø mm
27-210125-9	1,25	27-210315-9	3,15
27-210160-9	1,60	27-210400-9	4,00
27-210200-9	2,00	27-210500-9	5,00
27-210250-9	2,50	27-210630-9	6,30

Schraubenausdrehersatz

in Kassette

Screw extractor set

in box



Bestell-Nr. Order-no.	Teile Pieces	für Schrauben for screws
27-183005-9	5	M 3-18
27-183006-9	6	M 3-24
27-183008-9	8	M 3-50







Fliesen

Bearbeitung	222-224, 226
Kreuze/Keile	224
Fugengummi	224
Lochbohrer	225
Zubehör	227-228

Tiles

Cutting	222-224, 226
Crosse/Wedges	224
Rubber tile joint	224
Hole saw	225
Accessories	227-228



Glas

Glasschneider	234-237
Glasschaber	238
Saugheber	238-241
Glasbrechzange	241

Glass

Cutting	234-237
Scraper	238
Suction lifters	238-241
Breaking pliers	241



Wandbearbeitung

Farbrührer	226
Spachtel	241-245
Maurerkellen	246-249
Reibebretter	250-251

Wall

Paint mixer	226
Scrapers	241-245
Trowels	246-249
Floats	250-251



Duschezubehör

Brauseschläuche	252
Handbrausen	253
Befestigung	254-255

Shower accessories

shower hoses	252
hand showers	253
Fixing	254-255



Sonstiges

Markierungshilfen	228-229
Messer/Schere	230-232
Packnadeln	233
Türbesen	232
Klebeband	232

Others

Marking	228-229
Knives/shear	230-232
Needles	233
Draught excluder	232
Adhesive tape	232

Fliesenschneidmaschine JOKOSIT

- lackiert
- Schneidrädchen Ø 15 mm

Tile cutting machine JOKOSIT

- japanned
- cutting wheel Ø 15 mm



Bestell-Nr. Order-no.	Schneidlänge mm Cutting length mm	Fliesenstärke bis mm tile thickness up to mm
28-110030-0	300	10
28-110033-0	330	15
28-110040-0	400	15

Fliesenschneidmaschine JOKOSIT

- lackiert
- Schneidrädchen Ø 22 mm
- mit Anschlagwinkel 90°

Tile cutting machine JOKOSIT

- japanned
- cutting wheel Ø 22 mm
- with angle adjustment 90°



Bestell-Nr. Order-no.	Schneidlänge mm Cutting length mm	Fliesenstärke bis mm tile thickness up to mm
28-112047-0	470	18
28-112060-0	600	18
28-112080-0	800	18





Hartmetall-Schneidrädchen

für Fliesenschneidmaschine

Carbide cutting wheel

for tile cutting machine



Bestell-Nr. Order-no.	Ø mm Ø mm	für Maschinen for machines
28-116015-0	15	28-1100...
28-116022-0	22	28-1120...

Fliesenlochsneider

passend für alle Bohrmaschinen

Tile hole cutter

for all usual drilling machines



Bestell-Nr. Order-no.	Bohr Ø mm Bore Ø mm
28-118000-0	30 - 80
28-119000-0	Ersatzlochsneider/spare hole cutter

Fliesenkreuze

- weiss
- im Paket 250 Stück

Tile crosses

- white
- bag of 250 pieces

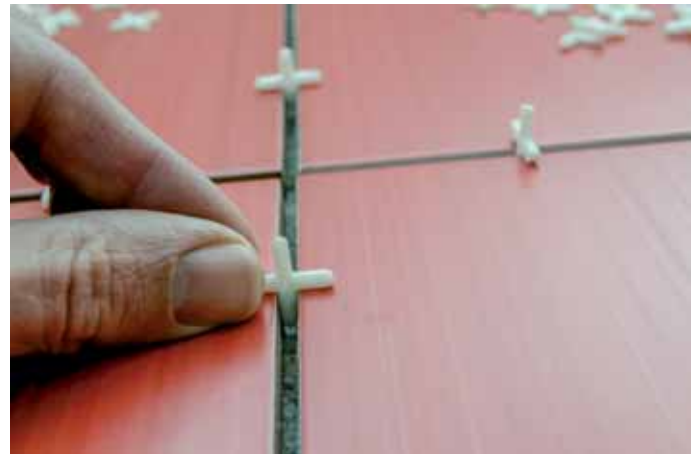

Bestell-Nr. Order-no.	Fugenbreite x Schenkellänge mm gap width x length mm
28-122000-0	2,0 x 18
28-122001-0	2,5 x 18
28-122002-0	3,0 x 18
28-122003-0	1,5 x 28
28-122004-0	2,0 x 28
28-122005-0	2,5 x 28
28-122006-0	3,0 x 28
28-122007-0	4,0 x 28
28-122008-0	5,0 x 28
28-122009-0	6,0 x 28

Fliesenkeile

Beutel 250 Stück

Tile wedges

bag of 250 pieces



Bestell-Nr. Order-no.	Höhe mm Height mm	Breite x Länge mm Width x length mm	Farbe Colour
28-123005-0	0-5	6 x 30	schwarz/black
28-123012-0	0-12	12 x 35	weiss/white

Fliesenschneider

mit rotem Griff

Tile cutter

with PVC handle



Bestell-Nr. Order-no.
28-130000-0

Fugengummi

mit Holzgriff

Rubber tile joint

with wooden handle



Bestell-Nr. Order-no.	Breite mm Width mm
28-144020-0	200
28-144030-0	300

Lochbohrer-Set

- 6-teilig
- mit Aufnahmeteller und Zentrierbohrer
- zum einfachen Bohren in
Mauerwerk
Fliesen
Ziegel
Gipskarton etc.

Hole saw set

- set of 6 pieces
- with aluminium plate and centre drill
- useable in
masonry
tiles
bricks
gypsum plaster etc.



Bestell-Nr. Order-no.	Ø mm Ø mm
28-146000-9	33, 53, 67, 73
28-146001-9	33, 53, 67, 83

Lochbohrer-Set im Profi-Koffer

- 8-teilig
- mit Aufnahmeteller und Zentrierbohrer
- mit Halbrundfeile 150 mm
- zum einfachen Bohren in
Mauerwerk
Fliesen
Ziegel
Gipskarton etc.

Hole saw set in case

- set of 8 pieces
- with aluminium plate and centre drill
- with half-round file 150 mm
- useable in
masonry
tiles
bricks
gypsum plaster etc.



Bestell-Nr. Order-no.	Bohrer Ø mm Bore Ø mm
28-146108-9	33, 53, 67, 73, 83

Lochbohrer

- zum einfachen Bohren in
Mauerwerk
Fliesen
Ziegel
Gipskarton etc.

Hole saw

- useable in
masonry
tiles
bricks
gypsum plaster etc.



Bestell-Nr. Order-no.	Bohrer Ø mm Bore Ø mm
28-147033-9	33
28-147043-9	43
28-147053-9	53
28-147067-9	67
28-147073-9	73
28-147083-9	83
28-147103-9	103

Zubehör für Lochbohrer

Accessories for hole saw



Bestell-Nr. Order-no.	Beschreibung Description	Abmessung mm Size mm
28-148000-9	Aufnahmeteller/aluminium plate	33-83
28-148001-9	Aufnahmeteller/aluminium plate	33-103
28-148100-9	Zentrierbohrer flach/pilot bit flat tip	140
28-148101-9	Zentrierbohrer spitz/pilot bit pointed tip	140

Farbrührer mit Ring

- verzinkt
- mit 6-kant
- für normale Rührarbeiten

Paint mixer

- zinc plated
- hexagonal
- for normal paint mixing work



Bestell-Nr. Order-no.	Ø x Länge mm Ø x length mm
28-150001-9	100 x 400
28-150002-9	100 x 570
28-150003-9	135 x 570

Wendelrührer Gewinde M 14

- verwendbar für
Farbe
Grundierungen
Zement
Fliesenkleber
Fertigputz
Spachtelmasse

Paint and concrete mixer M14

- for mixing
paints
cement and other various materials



Bestell-Nr. Order-no.	Ø x Länge mm Ø x length mm
28-151000-9	120 x 600
28-151001-9	120 x 740

Fugenkratzer

- HM-beschichtet

Grout rake

- carbide covered



Bestell-Nr. Order-no.	Detail Detail
28-155000-9	mit 2 Klingen/with 2 blades
28-156000-9	Klingensatzpaar/spare blade pair

Fliesenfeile

- HM-beschichtet
- flach
- mit Plastikgriff

Tiler's file

- carbide covered
- flat
- with plastic handle



Bestell-Nr. Order-no.	Feilenlänge mm file length mm
28-158000-9	200



MULTI Glättfix

Ideal zur Versiegelung von Fliesen, Glas, Duschkabinen, Badewannen etc.

MULTI Glättfix

for smoothing Silikon, for sealing of tiles, ceramics, glass, shower cabinets, bath tub etc.



Bestell-Nr. Order-no.	Information Information
28-160000-9	SB verpackt/ss-packing
28-162000-9	50 Stück im Thekenkarton/50 pieces in display

Fliesenschwamm Original „HYDRO“

Ideal zur Verfugung von Fliesen etc.

Sponge Original „HYDRO“

for tiler's worker



Bestell-Nr. Order-no.	Länge x Breite x Höhe mm Length x width x height mm
28-166000-9	170 x 115 x 70

FUGI zum Glätten von Silikon

- Versiegelung von Fliesen, Glas, Duschkabinen, Badewannen etc.
- in Kassette

FUGI Glättfix for smoothing silicon

- for sealing of tiles, ceramics, glass, shower cabinets, bath tub etc.
- in box



Bestell-Nr. Order-no.	Satz Set
28-163000-9	2-teilig/2 pieces
28-164000-9	3-teilig/3 pieces

Fliesenschwamm

Standard Qualität

Tiler's sponge

Standard quality



Bestell-Nr. Order-no.	Länge x Breite x Höhe mm Length x width x height mm
28-167000-9	180 x 110 x 60

Wasserschieber

- mit Moosgummi-Doppelstreifen
- mit Metallrücken

Foam rubber wiper

- with double foam
- metal back



Bestell-Nr. Order-no.	Breite mm Width mm
28-168035-0	350
28-168045-0	450
28-168060-0	600

Signierkreide unpapier

- Markierung von Eisen, Metall, Holz, Papier etc.
- wischfest und wetterbeständig
- 12 Stück im Karton

Marking crayon unpapere

- marking of iron, metal, wood, paper etc.
- wiping and weatherproof
- 12 pieces in box



Bestell-Nr. Order-no.	Länge mm Length mm	Farbe Colour
28-169001-0	120	weiss/white
28-169002-0	120	gelb/yellow
28-169003-0	120	rot/red
28-169004-0	120	blau/blue
28-169005-0	120	grün/green
28-169006-0	120	schwarz/black

Signierkreide papier

- Markierung von Eisen, Metall, Holz, Papier etc.
- wischfest und wetterbeständig
- 12 Stück im Karton

Marking crayon papere

- marking of iron, metal, wood, paper etc.
- wiping and weatherproof
- 12 pieces in box



Bestell-Nr. Order-no.	Länge mm Length mm	Farbe Colour
28-169101-0	120	weiss/white
28-169102-0	120	gelb/yellow
28-169103-0	120	rot/red
28-169104-0	120	blau/blue
28-169105-0	120	grün/green
28-169106-0	120	schwarz/black

Aluminium-Schlagschnurroller

- mit Farbpulver blau
- im Set

Chalkline, aluminium

- with blue powder
- set



Bestell-Nr.
Order-no.

28-170000-9

Länge m
Length m

30

Maurer-Lotschnur

auf Haspel

Mason's string

on bobbin



Bestell-Nr.
Order-no.

28-179050-0

Länge m
Length m

50

Ø mm
Ø mm

1,0

Farbpulver blau

für Schlagschnurroller

Chalk blue

for chalk line



Bestell-Nr.
Order-no.

28-171018-9

28-171040-9

Gewicht gramm
weight gram

180

400

Gummigipsbecher

- konisch
- schwarz

Rubber cup

- conical
- black



Bestell-Nr.
Order-no.

28-185065-0

Abmessung mm
Size mm

125 x 65

Universal-Messer

- mit festehender Klinge
- mit fünf Trapezklingen
- Griff lackiert

Universal knife

- with fixed blade
- with five trapezform blades
- knife varnished



Bestell-Nr.	Länge mm
Order-no.	Length mm
28-190000-0	170

Universal-Messer

- mit einziehbarer Klinge
- mit fünf Trapezklingen
- Griff lackiert

Universal knife

- with retractable blade
- with five trapezform blades
- knife varnished



Bestell-Nr.	Länge mm
Order-no.	Length mm
28-192000-0	175

Automatikmesser

- automatischer Klinsenrückzug
- rot lackiert
- mit fünf Trapezklingen

Automatic knife

- automatic return of blade
- with five trapezform blades



Bestell-Nr.	Länge mm
Order-no.	Length mm
28-192200-0	170

Dämmstoffmesser

- mit Metallheft

Insulating material cutting knife

- metal handle



Bestell-Nr.	Klingenlänge mm	Gesamtlänge mm
Order-no.	Blade length mm	Total length mm
28-192500-0	140	240
28-196500-0	Ersatzklinge/spare blade 140 x 19 x 0,90	



TRAPEZ-Klingen

20 Pack à fünf Stück im Karton

Trapezform blades

20 pack of five pieces in box

Bestell-Nr.
Order-no.**28-195000-0**Länge x Breite x Stärke mm
Length x width x strength mm

60 x 19 x 0,65

HAKEN-Klingen

20 Pack à fünf Stück im Karton

Hook blades

20 pack of five pieces in box

Bestell-Nr.
Order-no.**28-196000-0**Länge x Breite x Stärke mm
Length x width x strength mm

52 x 19 x 0,50

Universalmesser verstellbare

- mit rutschfestem Griff
- mit abbrechbarer Klinge 18 mm

Blade cutter retractable

with breakable blade 18 mm

Bestell-Nr.
Order-no.**28-198000-9**Länge mm
Length mm

175

28-199000-9

Ersatzklinge/spare blade 18 mm (10 Stück/pieces)

Spiegel-Klebeband

doppelseitig klebend

Adhesive tape/ribbon

double sided adhesive



Bestell-Nr. Order-no.	Breite mm x Länge m Width mm x length m
28-200001-0	10 x 5
28-200002-0	10 x 10
28-200003-0	10 x 25
28-200004-0	10 x 50
28-200005-0	12 x 5
28-200007-0	12 x 10
28-200006-0	12 x 25
28-200013-0	12 x 50
28-200008-0	19 x 2,5
28-200009-0	20 x 5
28-200010-0	20 x 10
28-200011-0	30 x 5
28-200012-0	50 x 5

Türbesen-/Bodendichtung

- Kunststoff
- 1 m lang
- selbstklebend

Draught excluder

- PVC
- 1 m
- self-adhesive



Bestell-Nr. Order-no.	Farbe Colour
28-205001-0	weiss/white
28-205002-0	braun/brown
28-205003-0	transparent/transparent
28-205004-0	nussbaum/nut brown
28-205005-0	eiche/oak

Mehrzweck-Schere

mit ergonomischem Plastikgriff

Universal scissors

with ergonomic PVC handle



Bestell-Nr. Order-no.	Länge mm Length mm
28-203022-9	220
28-203025-9	250



Pack-/Speernadel

mittelstark

Packing needles

medium



Bestell-Nr. Order-no.	Länge mm Length mm
28-208015-0	150
28-208017-0	175

Garniernadel

halb-gebogen

Garnishing needle

semi-bent



Bestell-Nr. Order-no.	Länge mm Length mm	für Draht Ø mm for wire Ø mm
28-208502-0	50	1,0
28-208503-0	75	1,4
28-208504-0	100	1,8
28-208505-0	125	2,0
28-208506-0	150	2,2
28-208507-0	175	2,4
28-208508-0	200	2,6
28-208510-0	250	2,8



Scheibenschneider

- mit Maßeinteilung
- mit Holzgriff

Gasket cutter

- with scale
- with wooden handle

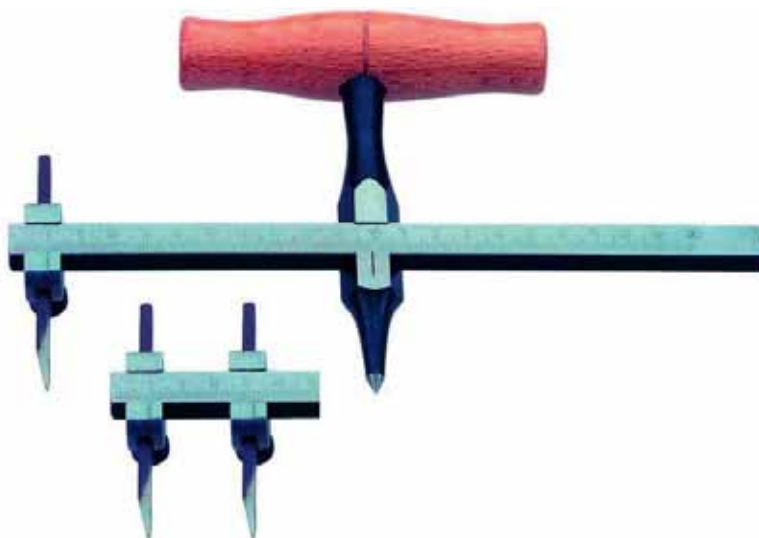

Bestell-Nr. Order-no.	Ø mm Ø mm	Schneidmesser Cutting knives
28-230020-0	200	1
28-230030-0	300	1
28-230040-0	400	1
28-230060-0	600	1
28-230080-0	800	1

Bestell-Nr. Order-no.	Ø mm Ø mm	Schneidmesser Cutting knives
28-231020-0	200	2
28-231030-0	300	2
28-231040-0	400	2
28-231060-0	600	2
28-231080-0	800	2
28-232000-0	Ersatzmesser/spare knife	

Rundglasschneider SILBERSCHNITT

- mit Maßeinteilung
- mit sechs Schneidradchen

Circle cutter SILBERSCHNITT

- with graduation
- with six steel cutting wheels



Bestell-Nr. Order-no.	bis Ø mm up to Ø mm
28-238006-0	600
28-238012-0	1.200
28-238020-0	2.200



Glasschneider JOBO

- mit sechs Schneidrädchen
- rotes Holzheft

Glass cutter JOBO

- with six steel cutting wheels
- red wooden handle



Bestell-Nr.
Order-no.

28-239000-0

für Glasstärken mm
for glass thickness mm

3-8

Glasschneider SILBERSCHNITT

- mit sechs Schneidrädchen
- mit Holzheft

Glass cutter SILBERSCHNITT

- with six cutting wheels
- wooden handle



Bestell-Nr.
Order-no.

28-241000-0

für Glasstärken mm
for glass thickness mm

3-10 (100.0)

JOKRA Glasschneider

- mit sechs Schneidrädchen
- braunes Holzheft

JOKRA Glass cutter

- with six steel cutting wheels
- brown wooden handle



Bestell-Nr.
Order-no.

28-239500-0

für Glasstärken mm
for glass thickness mm

3-8

Glasschneider SILBERSCHNITT

- mit sechs Schneidrädchen
- schwere Ausführung
- mit Holzheft

Glass cutter SILBERSCHNITT

- with six cutting wheels
- heavy pattern
- with wooden handle



Bestell-Nr.
Order-no.

28-243000-0

für Glasstärken mm
for glass thickness mm

3-15 (110.0)

Glasschneider STANDARD

- mit sechs Schneidrädchen
- mit rotem Holzgriff

Glass cutter STANDARD

- with six cutting wheels
- red handle



Bestell-Nr.
Order-no.

28-240000-0

für Glasstärken mm
for glass thickness mm

3-8

Ersatzschneidrädchen SILBERSCHNITT

Spare cutting wheels SILBERSCHNITT



Bestell-Nr.
Order-no.

28-244000-0

für Glasstärken mm
for glass thickness mm

3-10

Öl-Glasschneider SILBERSCHNITT

- Messinggriff
- schmaler Schneidkopf
- für Formschnitte
- Kopf bis 30° beweglich

Oil glass cutter SILBERSCHNITT

- slim head
- all brass
- mainly for contour cut
- head 30° agile



Bestell-Nr.
Order-no.

28-250000-0

für Glasstärken mm
for glass thickness mm

3-10 (447.8)

Öl-Glasschneider SILBERSCHNITT

- Kunststoffgriff
- schmaler Schneidkopf

Oil glass cutter SILBERSCHNITT

- slim head
- PVC handle



Bestell-Nr.
Order-no.

28-250012-0

für Glasstärken mm
for glass thickness mm

3-10 (4001.1)

Öl-Glasschneider SILBERSCHNITT

- Messinggriff
- schmaler Schneidkopf

Oil glass cutter SILBERSCHNITT

- slim head
- all brass



Bestell-Nr.
Order-no.

28-250010-0

für Glasstärken mm
for glass thickness mm

3-10 (4000.1E)

Öl-Glasschneider SILBERSCHNITT

- Messinggriff
- breiter Schneidkopf

Oil glass cutter SILBERSCHNITT

- wide head
- all brass



Bestell-Nr.
Order-no.

28-250014-0

für Glasstärken mm
for glass thickness mm

3-10 (5000.0E)



Öl-Glasschneider SILBERSCHNITT

- Kunststoffgriff
- breiter Schneidkopf

Oil glass cutter SILBERSCHNITT

- wide head
- PVC handle



Bestell-Nr.
Order-no.
28-250016-0

für Glasstärken mm
for glass thickness mm
3-10 (5001.0E)



Öl-Glasschneider SILBERSCHNITT

- Messinggriff
- breiter Schneidkopf
- drehbar
- Schneidwinkel 138°

Oil glass cutter SILBERSCHNITT

- wide head
- all brass
- mainly for contour cut
- head 138° agile



Bestell-Nr.
Order-no.
28-251000-0

für Glasstärken mm
for glass thickness mm
3-10 (448.8)

Schneidkopf

für Öl-Glasschneider

Spare cutting head

for oil glass cutter



Bestell-Nr.
Order-no.
28-258001-0
28-258002-0

Detail
Detail
schmal/narrow 4010.1
breit/wide 5010.0

für Glasschneider
for glasscutter
4.000.1/4.001.1/447.8
5.000/5.001

Glasschaber

- rot
- aus Kunststoff
- mit Aufhängeloch

Glass scraper

- red
- made of PVC
- with hanger hole



Bestell-Nr.
Order-no.

Detail
Detail

28-260000-0

Glasschaber/Glass scraper

28-261000-0

Ersatzklinge/spare blade

Saugheber VERIBOR

- 1-Kopf-Alu
- blue line

Suction lifter VERIBOR

- 1-cup
- blue line



Bestell-Nr.
Order-no.

Tragkraft kg
lifting capacity kg

28-265030-0

40 (BO600.0BL)

Saugheber VERIBOR

- 1-Kopf-Alu
- silver line

Suction lifter VERIBOR

- 1-cup
- silver line



Bestell-Nr.
Order-no.

Tragkraft kg
lifting capacity kg

28-265031-0

40 (BO600.0)

Saugheber VERIBOR

- 2-Kopf-Alu
- mit Längsgriff
- blue line

Suction lifter VERIBOR

- 2-cup
- handle lengthwise
- blue line



Bestell-Nr.
Order-no.
28-266060-0

Tragkraft kg
lifting capacity kg
60 (B0602.4BL)

Saugheber VERIBOR

- 2-Kopf-Alu
- silver line

Suction lifter VERIBOR

- 2-cup
- silver line



Bestell-Nr.
Order-no.
28-266061-0

Tragkraft kg
lifting capacity kg
60 (B0602.4)

Saugheber VERIBOR

- 2-Kopf-Alu
- blue line

Suction lifter VERIBOR

- 2-cup
- blue line



Bestell-Nr.
Order-no.
28-266070-0

Tragkraft kg
lifting capacity kg
70 (B0602.0BL)

Saugheber VERIBOR

- 3-Kopf-Alu
- blaue Linie

Suction lifter VERIBOR

- 3-cup
- blue line



Bestell-Nr.
Order-no.

28-267010-0

Tragkraft kg
lifting capacity kg

100 (BO603.0BL)

Saugheber VERIBOR

- 3-Kopf-Alu
- silver line

Suction lifter VERIBOR

- 3-cup
- silver line



Bestell-Nr.
Order-no.

28-267011-0

Tragkraft kg
lifting capacity kg

100 (BO603.0)



Ersatz-Saugheberscheiben

Spare suction pad



Bestell-Nr.
Order-no.

28-268040-0

28-268080-0

für Tragkraft kg
for lifting capacity kg

bis/up to 40

über/over 40

Japan-Malerspachtelsatz

- 4-teilig
- im Polybeutel

Japan wall scraper set

- set of 4 pieces
- in polybag



Bestell-Nr.
Order-no.

28-290000-0

Breite mm
Width mm

50 - 80 - 100 - 120

Glasbrechzange

- Kopf poliert
- breite Backen
- lackiert

Glass breaking pliers

- head polished
- wide jaws
- varnished



Bestell-Nr.
Order-no.

28-270018-0

Länge mm
Length mm

180

Japan-Malerspachtelsatz

- 4-teilig
- mit rundem Hals
- im Polybeutel

Japan wall scraper set

- set of 4 pieces
- round neck
- in polybag



Bestell-Nr.
Order-no.

28-291000-0

Breite mm
Width mm

50 - 80 - 100 - 120

PVC-Flächenspachtelsatz

- 4-teilig
- im Polybeutel

PVC scraper set

- set of 4 pieces
- in polybag



Bestell-Nr.
Order-no.

28-293000-0

Breite mm
Width mm

50 - 80 - 100 - 120

Metall-Ziehklinge

- kantig
- blank

Scraper

- square edged
- polished



Bestell-Nr.
Order-no.

28-300000-0

Länge x Breite x Stärke mm
Length x width x strength mm

150 x 60 x 0,8



Schwanenhals-Ziehklinge

blank

Scraper type swan neck

polished



Bestell-Nr.
Order-no.
28-301000-0

Malerspachtel FLEX

- mit ovalem Holzheft
- mit Aufhängeloch

Wall scraper FLEX

- with oval wooden handle
- with pin hole



Bestell-Nr. Order-no.	Klingenbreite mm Blade width mm
28-310020-0	20
28-310030-0	30
28-310040-0	40
28-310050-0	50
28-310060-0	60
28-310070-0	70
28-310080-0	80
28-310090-0	90
28-310120-0	100
28-310100-0	120

Malerspachtel

- blanke Klinge
- mit Holzheft

Painter's wall scraper

- polished blade
- wooden handle



Bestell-Nr. Order-no.	Klingenbreite mm Blade width mm
28-310025-9	25
28-310040-9	40
28-310050-9	50
28-310060-9	60
28-310080-9	80
28-310100-9	100

Malerspachtel

- rostfrei
- GS-geprüft
- schwarzes Kunststoffheft

Painter's wall scraper

- stainless steel
- GS-approval
- black PVC-handle



Bestell-Nr. Order-no.	Klingenbreite mm Blade width mm
28-313004-0	40
28-313005-0	50
28-313006-0	60
28-313008-0	80
28-313010-0	100
28-313012-0	120

Malerspachtel YORK-TYPE

- mit schwerem Holzgriff
- Blatt blank geschliffen
- mit Kupfernieten

Wall scraper YORK-TYPE

- heavy duty wooden handle
- blade polished
- with copper rivets



Bestell-Nr. Order-no.	Klingenbreite mm Blade width mm
28-313503-0	30
28-313504-0	40
28-313505-0	50
28-313506-0	60
28-313507-0	70
28-313508-0	80
28-313509-0	90
28-313510-0	100
28-313511-0	110
28-313512-0	120
28-313514-0	140

Flächenspachtel

- gerade Form
- mit Holzheft und SB-Loch

Scraper long type

- straight shape
- with wooden handle and hole



Bestell-Nr. Order-no.	Breite mm Width mm
28-316520-0	200
28-316525-0	250
28-316530-0	300



Zahnspachtel

- fein, Zahn B 1
- Zahnabstand 2,4 mm
- Zahntiefe 2,0 mm
- mit Holzgriff

Glue scraper

- fine, tooth B 1
- teeth interval 2,4 mm
- depth 2,0 mm
- with wooden handle



Bestell-Nr.
Order-no.

28-320518-0

Klingenbreite mm
Blade width mm

180

Zahnspachtel

- extra grob, Zahn B 6
- Zahnabstand 4,1 mm
- Zahntiefe 3,6 mm
- mit Holzgriff

Glue scraper

- extra coarse, tooth B 6
- teeth interval 4,1 mm
- depth 3,6 mm
- wooden handle



Bestell-Nr.
Order-no.

28-321518-0

Klingenbreite mm
Blade width mm

180

Zahnspachtel

- extra-fein, Zahn A 4
- Zahnabstand 1,1 mm
- Zahntiefe 0,75 mm
- mit Holzgriff

Glue scraper

- extra fine, tooth A 4
- teeth interval 1,1 mm
- depth 0,75 mm
- wooden handle



Bestell-Nr.
Order-no.

28-321500-0

Klingenbreite mm
Blade width mm

180

Zahnspachtel

- grob, Zahn B 3
- Zahnabstand 3,7 mm
- Zahntiefe 3,25 mm
- mit Holzgriff

Glue scraper

- coarse, tooth B 3
- teeth interval 3,7 mm
- depth 3,25 mm
- wooden handle



Bestell-Nr.
Order-no.

28-323518-0

Klingenbreite mm
Blade width mm

180

Glättekelle rostfrei

mit Holzgriff

Plastering trowel stainless

wooden handle



Bestell-Nr. Order-no.	Länge x Breite x Stärke mm Length x width x strength mm
28-319928-0	280 x 140 x 0,7

Glättekelle

- Blatt blank
- mit rotem Holzgriff

Plastering trowel

- polished blade
- with wooden handle



Bestell-Nr. Order-no.	Länge x Breite x Stärke mm Length x width x strength mm
28-320028-0	280 x 130 x 0,7
28-322050-0	500 x 130 x 0,7

Glättekelle

- mit Zahnung an zwei Seiten
- Blatt blank
- mit rotem Holzgriff

Plastering trowel

- tothing on two sides
- polished blade
- with red wooden handle

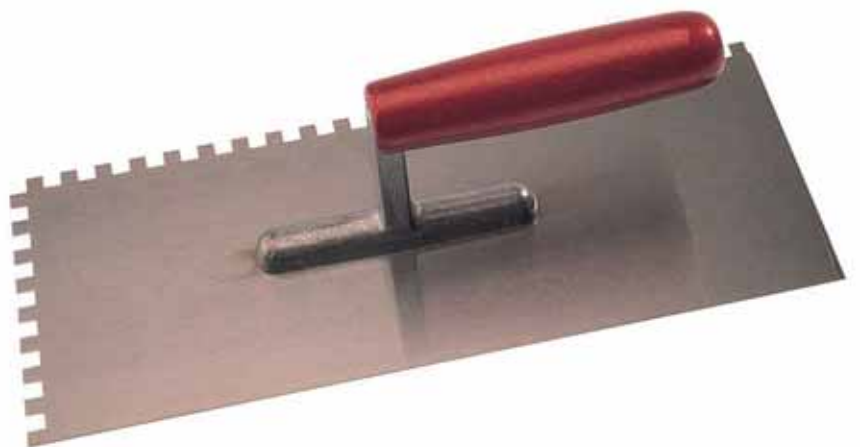

Bestell-Nr. Order-no.	Länge x Breite x Stärke mm Length x width x strength mm	Zahn mm Teeth mm
28-324006-0	280 x 130 x 0,7	6
28-324008-0	280 x 130 x 0,7	8
28-324010-0	280 x 130 x 0,7	10
28-324015-0	280 x 130 x 0,7	15
28-325010-0	500 x 130 x 0,7	10





Glättekelle mit Eisenstütze

- gerade Form
- poliertes Blatt
- Naturholzgriff
- genagelt

Plastering trowel with iron support

- square
- polished blade
- natural wooden handle
- nailed



Bestell-Nr.
Order-no.

28-325528-0

Länge x Breite x Stärke mm
Länge x Breite x Stärke mm

280 x 130 x 0,7

Glättekelle mit Eisenstütze

- runde Form
- poliertes Blatt
- Naturholzgriff
- genagelt

Plastering trowel with iron support

- round
- polished blade
- natural wooden handle
- nailed



Bestell-Nr.
Order-no.

28-325628-0

Länge x Breite x Stärke mm
Länge x Breite x Stärke mm

280 x 80 x 100 x 0,7

Italienische Maurerkelle

- gerade
- poliertes Blatt
- mit rotem Holzheft

Italian brick trowel

- with straight shoulder
- polished blade
- red wooden handle



Bestell-Nr.
Order-no.

28-326020-0

Länge mm
Length mm

200

Dachdecker-Spezial-Arbeitskelle

- poliertes Blatt
- Griff rot und abgewinkelt

Roofer special working trowel

- polished blade
- red wooden handle



Bestell-Nr.
Order-no.

28-327015-0

Länge mm
Length mm

155



Katzenzunge

- Blatt konisch poliert
- besonders flexibel
- rotes Holzheft

Cat tongue shaped trowel

- blade very flexible
- polished
- red wooden handle



Bestell-Nr.
Order-no.
28-328016-0

Länge mm
Length mm
160

Mauerkelle gerade Schulter

- poliertes Blatt
- mit Holzheft

Greek brick trowel

- straight shoulder
- polished blade
- wooden handle



Bestell-Nr.
Order-no.

Länge mm
Length mm

28-340018-0	180
28-340020-0	200
28-340022-0	220
28-340024-0	240
28-340026-0	260
28-340028-0	280

Mauerkelle WALBY

- poliertes Blatt
- mit rotem Holzheft

Brick trowel WALBY

- polished blade
- with red wooden handle



Bestell-Nr.
Order-no.
28-335005-0

Länge Zoll
Length inch

28-335005-0	5
28-335006-0	6
28-335007-0	7
28-335008-0	8
28-335009-0	9

Mauerkelle schräge Schulter

- poliertes Blatt
- mit Holzheft

Greek brick trowel

- oblique shoulder
- polished blade
- wooden handle



Bestell-Nr.
Order-no.

Länge mm
Length mm

28-341018-0	180
28-341020-0	200
28-341022-0	220
28-341024-0	240
28-341026-0	260
28-341028-0	280

Hydro-Reibebrett

- mit gelber Schwammauflage
- Brett aus Kunststoff

Hydro sponge float

- with yellow sponge overlay
- PVC float



Bestell-Nr. Länge x Breite x Höhe mm
 Order-no. Length x width x height mm
28-350028-0 280 x 140 x 30

Schwammgummi-Reibebrett

- Schwamm sehr fein
- orange
- Brett aus Kunststoff

Plastic float

- very fine rubber foam
- orange
- PVC float



Bestell-Nr. Länge x Breite x Höhe mm
 Order-no. Length x width x height mm
28-356000-0 280 x 140 x 18

Verfugungsbrett

- mit schwarzem Zellkautschuk
- Brett aus Kunststoff

Plastic float

- with black cellular rubber
- PVC float



Bestell-Nr. Länge x Breite x Höhe mm
 Order-no. Length x width x height mm
28-355028-0 280 x 140 x 08

Schwammgummi-Reibebrett

- Schwamm fein/mittel
- orange
- Brett aus Kunststoff

Plastic float

- fine/medium rubber foam
- orange
- PVC float

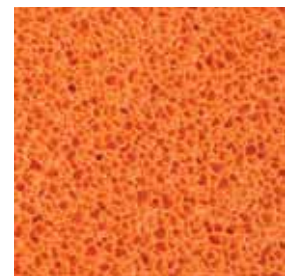

Bestell-Nr. Länge x Breite x Höhe mm
 Order-no. Length x width x height mm
28-356100-0 280 x 140 x 18



Schwammgummi-Reibebrett

- Schwamm grob
- orange
- Brett aus Kunststoff

Plastic float

- rough coarse rubber foam
- orange
- PVC float

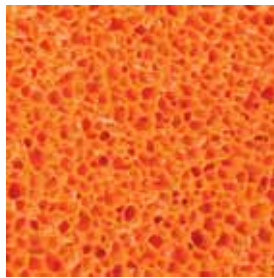

Bestell-Nr. Order-no.	Länge x Breite x Höhe mm Length x width x height mm
28-356200-0	280 x 140 x 18

Kunststoff-Reibebrett

- abriebfest
- formstabil
- sehr gute Reibeigenschaften

Plastic float

- abrasion proof
- dimensionally stable
- very good rubbing characteristic



Bestell-Nr. Order-no.	Länge x Breite mm Length x width mm
28-359028-0	280 x 140
28-359032-0	320 x 180
28-359036-0	360 x 200



Metall-Brauseschlauch

- besonders flexibel
- verchromt
- Ø 12 mm

Metal shower hose

- extremely flexible
- conical/hexagonal
- Ø 12 mm



Bestell-Nr. Order-no.	Länge m Length m	Schraubverbindung Screw connection
28-402000-9	1,5	1/2 x 1/2"
28-402020-9	2,0	1/2 x 1/2"
28-403000-9	1,5	1/2 x 3/4"
28-403020-9	2,0	1/2 x 3/4"

Flex-Brauseschlauch CLARA

- silber/schwarz-farbig
- aus Kunststoff
- Ø 8 mm

Flex shower hose CLARA

- silver/black
- made of PVC
- Ø 8 mm



Bestell-Nr. Order-no.	Länge m Length m	Schraubverbindung Screw connection
28-405515-0	1,5	1/2 x 1/2"
28-405615-0	1,5	1/2 x 3/4"

PVC-Brauseschlauch

- weiß
- Ø 8 mm

PVC shower hose

- white
- Ø 8 mm



Bestell-Nr. Order-no.	Länge m Length m	Schraubverbindung Screw connection
28-404015-0	1,5	1/2 x 1/2"
28-404020-0	2,0	1/2 x 1/2"
28-405015-0	1,5	1/2 x 3/4"
28-405020-0	2,0	1/2 x 3/4"

Metall-Flex-Brauseschlauch

- besonders flexibel
- verchromt
- Ø 8 mm

Metal flex shower hose

- extremely flexible
- conical/hexagonal
- Ø 8 mm



Bestell-Nr. Order-no.	Länge m Length m	Schraubverbindung Screw connection
28-406015-9	1,5	1/2 x 1/2"
28-406020-9	2,0	1/2 x 1/2"
28-407015-9	1,5	1/2 x 3/4"
28-407020-9	2,0	1/2 x 3/4"



Handbrause TELE

- weiß
- Ø 100 mm

Hand shower TELE

- white
- Ø 100 mm



Bestell-Nr.
Order-no.

28-411000-9

Anschluss
connection

1/2"

Handbrause LUXUS

- verchromt
- mit 3 Funktionen

Hand shower LUXUS

- chromium plated
- 3 functions



Bestell-Nr.
Order-no.

28-411100-9

Anschluss
connection

1/2"



Gelenkstück

- aus Metall
- verchromt

Adjustable connector

- all metal
- chromium plated



Bestell-Nr.
Order-no.

28-412000-0

Anschluss
connection

1/2"

Wandhaken

- für Handbrause
- verchromt

Wall hook

- for hand shower
- chromium plated



Bestell-Nr.
Order-no.

28-414000-0

Sprühkopf

- Kunststoffkugelkopf
- schwenkbar
- Umstellgriff verchromt
- 30 Stück im SB-Karton

Water Fix

- synthetic head-joint
- chrome adjusting grip
- in box of 30 pieces



Bestell-Nr.
Order-no.

28-420000-0

Farbe
Colour

chrom-weiß/chrome-white

28-420001-0

chrom-schwarz/chrome-black





Spiegelhalteklammern

Satz bestehend aus 4 Klammern, Schrauben und Dübeln

Mirror clip set

with 4 clips, screws and plugs



Bestell-Nr.
Order-no.

Material
Material

28-430000-0

Messing verchromt/brass chrome plated

28-431000-0

Edelstahl poliert/stainless steel polished

28-432000-0

Kunststoff klar/PVC clear



**Pflege/Polituren**

Metallpflege	258, 261
Acrylglas	258
Edelmetalle	259-260
Kunststoff	259-260
Leder	260

Polishing

Metal	258, 261
Acrylic	258
Stainless steel	259-260
Plastic	259-260
Leather	260

**Befestigung**

Zurrgurte	263
Schlauchschelle	265-266
Elastikteller	267
Schlüsselanhänger	268
Bodenträgerschienen	269

Fixing material

Lashing systems	263
Hose clamps	265-266
Pads	267
Key Rings / Tags	268
U-rails	269

**Reinigung**

Waschpaste	261
Besen	264

Cleaning

Cleaning paste	261
Brushes	264

**Dachdeckerbedarf**

Zangen	273
Nageleisen	273

Roofer's demand

Pliers	273
Slate ripper	273

**Sonstiges**

Kopflampen	262
Türstopper	270
Taschenfederwaage	270
Rollfedern	270
Schafschere	270
Tierfallen	271
Tauchsieder	272

Others

Headlamps	262
Door buffer	270
Pocket balances	270
Volute springs	270
Sheep shear	270
Animal traps	271
Immersion heater	272

Metallpflege DURSOL SHINE

- Reinigungs- und Pflegemittel für alle Gegenstände aus
Chrom
Aluminium
Stahl
Messing
Kupfer
Zinn

Metal polish DURSOL SHINE

- for general purpose of
chrome
aluminium
steel
brass
copper



Bestell-Nr.	Inhalt ml
Order-no.	Content ml
29-100000-0	75

Motorad/Auto Metallpflege AUTOSOL

International ausgezeichnetes Reinigungs- und Pflegemittel für alle metallischen Oberflächen

Car/bike metal polish AUTOSOL

for all kinds of metal surfaces also in industrial area moulds machines etc.



Bestell-Nr.	Inhalt ml
Order-no.	Content ml
29-101000-0	75

Acrylglaspolitur AUTOSOL

zur Entfernung von Kratzern auf Acrylglasflächen

Acrylic polish AUTOSOL

to remove scratches from acrylic surfaces



Bestell-Nr.	Inhalt ml
Order-no.	Content ml
29-101500-0	75

Gold- und Silberpolitur AUTOSOL

Pflegemittel für Oberflächen aus Gold, Silber und andere Edelmetallen

Gold and silver polish AUTOSOL

ideal for cleaning gold, silver, platinum etc.



Bestell-Nr. Order-no.	Inhalt ml Content ml
29-102000-0	75

Edelstahlpolitur AUTOSOL

Ideal zum Pflegen und Polieren von Edelstahl

Stainless steel polish AUTOSOL

designed to polish to an extremely high lustre



Bestell-Nr. Order-no.	Inhalt ml Content ml
29-103000-0	75

Kunststoffreiniger AUTOSOL

- Reiniger für alle Kunststoffteile
- entfernt zum Beispiel Nikotinbeläge und Schuhabrieb
- gibt neuen Glanz

Plastic cleaner AUTOSOL

- for all plastic surfaces
- removes e.g. nicotine film and shoe scoring
- gives new shine



Bestell-Nr. Order-no.	Inhalt ml Content ml
29-104000-0	75

Leder-Reiniger AUTOSOL

für alle glatten Lederarten und Vinyl-Leder

Leather cleaner AUTOSOL

cleaner for smooth leather vinyl and artificial leather



Bestell-Nr. Order-no.	Inhalt ml Content ml
29-105000-0	75

Aluminium-Politur AUTOSOL

speziell für die Behandlung von unbehandeltem Aluminium. Verleiht Schutz und Glanz.

Aluminium polish AUTOSOL

especially designed for aluminium which shines to a high gloss without scratching or hazing the surface



Bestell-Nr. Order-no.	Inhalt ml Content ml
29-106000-0	75

Kratzer Entferner AUTOSOL

zum Entfernen leichter Kratzer auf Kunststoffglas- und Lackoberflächen

Cratch remover AUTOSOL

removes light scratches on acrylic and painted metal surfaces



Bestell-Nr. Order-no.	Inhalt ml Content ml
29-106100-0	75

Marine Polierpaste AUTOSOL

für GFK- und Metallflächen geeignet

Marine polishing paste AUTOSOL

usable for boat surfaces all bright metal parts



Bestell-Nr.
Order-no.

29-106200-0

Inhalt ml
Content ml

75

Handwaschpaste CROLDINO

reinigt hautschonend von Öl, Fett, Schmierstoffen etc.

Hand cleaning paste CROLDINO

cleans from oil, rease, lubricants etc.



Bestell-Nr.
Order-no.

29-106300-0

Inhalt ml
Content ml

500



Handreinigungscreme CROLDINO

geeignet für hartnäckige Verschmutzungen

Hand cleaning cream CROLDINO

all-purpose hand cleaning
creme for heavily soiled
or discoloured hands



Bestell-Nr.
Order-no.

29-106400-0

Inhalt ml
Content ml

100

Kopflampe/Stirnlampe

- mit Kopfband
- 3 Beleuchtungspositionen
- 8 LED's
- ohne Batterie

Headlamp

- with headband
- 3 different lightening positions
- 8 LED's
- without battery



Bestell-Nr.
Order-no.

29-108000-9

Kopflampe/Stirnlampe

- mit Kopfband
- Leuchte verstellbar
- 12 LED's
- mit Batterie

Headlamp

- with headband
- light adjustable
- 12 LED's
- with battery



Bestell-Nr.
Order-no.

29-109000-0

Automatik-Zurrgurt

- mit Spitzhaken
- gefertigt nach DIN EN 12195-2
- automatische Gurtbandaufrollung

Automatic webbing load

- restraint assembly
- manufactured accordance to DIN EN 12195-2
- automatic reeling



Bestell-Nr. Order-no.	Länge m Length m	Breite mm Width mm
29-110000-9	3	25

Zurrgurt

- mit Spitzhaken
- 2-teilig mit doppelter Sicherheitsratsche
- Gurtband 100% PE
- Bruchlast 6000 kg

Lashing system

- with 2 hooks
- with double security lock ratched
- belt strap 100% PE
- breaking load 6000daN



Bestell-Nr. Order-no.	Länge m Length m	Breite mm Width mm
29-115010-0	10	50
29-115009-0	9	50

Straßenbesen ELASTON

- mit Holzrücken
- rote Borsten

Street broom ELASTON

- wooden back
- red bristles



Bestell-Nr. Order-no.	Breite mm Width mm
29-120029-0	290
29-120040-0	400
29-120060-0	600

Stahldraht-Besen

- mit Holzrücken
- flache Form

Steel broom

- with wooden back
- flat series



Bestell-Nr. Order-no.	Breite mm Width mm
29-123030-0	300

Holz-, Besen- und Gerätestiel

- astfrei
- beide Seiten flach

Wooden handle

- both sides flat

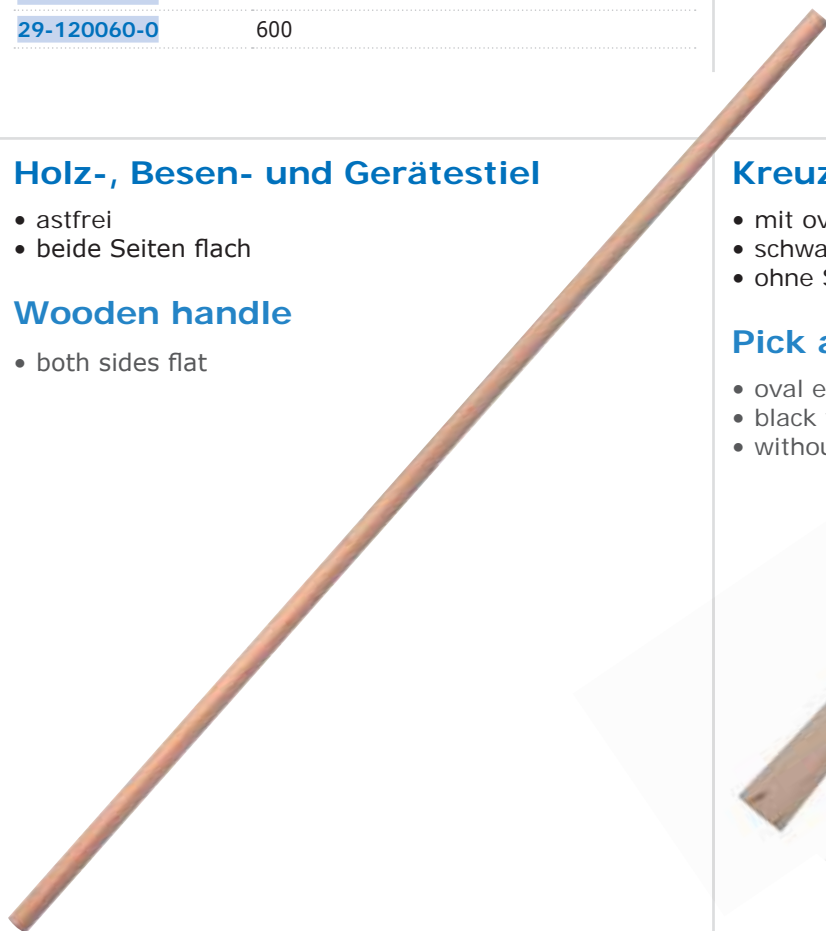

Bestell-Nr. Order-no.	Länge mm Length mm	Ø mm Ø mm
29-121013-0	1.300	24
29-121014-0	1.400	24
29-121015-0	1.500	24

Kreuzhacke

- mit ovalem Auge
- schwarz lackiert
- ohne Stiel

Pick axe

- oval eye
- black varnished
- without handle



Bestell-Nr. Order-no.	Artikel Item
29-165025-9	Kreuzhacke/pick axe 2.5 kg
29-165030-9	Kreuzhacke/pick axe 3,0 kg
29-166025-0	Stiel für/handle for 2,5 + 3,0 kg



Schlauchschelle DIN 3017

- aus Stahl, glanzverzinkt
- geschlitzte Sechskantschraube SW 7
- mit integriertem Kreuzschlitz

Hose clamp DIN 3017

- made of steel, bright zinc coated
- slotted hexagonal screw 7 mm
- with cross slot

**Bandbreite 9 mm
Strip width 9 mm**

Bestell-Nr. Order-no.	Spannbereich mm Capacity mm	Bandstärke mm Strip thickness mm
29-170012-0	8-12	0,7
29-170016-0	10-16	0,7
29-170020-0	12-20	0,7
29-170022-0	12-22	0,7
29-170025-0	16-25	0,7
29-170027-0	16-27	0,7
29-170032-0	20-32	0,7
29-170035-0	23-35	0,7
29-170040-0	25-40	0,7
29-170050-0	32-50	0,8
29-170060-0	40-60	0,8
29-170070-0	50-70	0,8
29-170130-0	110-130	0,8

**Bandbreite 12 mm
Strip width 12 mm**

Bestell-Nr. Order-no.	Spannbereich mm Capacity mm	Bandstärke mm Strip thickness mm
29-175020-0	12-20	0,8
29-175022-0	12-22	0,8
29-175025-0	16-25	0,8
29-175027-0	16-27	0,8
29-175032-0	20-32	0,8
29-175035-0	23-35	0,8
29-175040-0	25-40	0,8
29-175050-0	32-50	1,0
29-175060-0	40-60	1,0
29-175070-0	50-70	1,0
29-175080-0	60-80	1,0
29-175090-0	70-90	1,0
29-175100-0	80-100	1,0
29-175110-0	90-110	1,0
29-175120-0	100-120	1,0
29-175130-0	110-130	1,0
29-175140-0	120-140	1,0
29-175150-0	130-150	1,0
29-175160-0	140-160	1,0
29-175170-0	150-170	1,0
29-175180-0	160-180	1,0
29-175210-0	190-210	1,0

Schlauchschelle

- aus rostfreiem Stahl
- 100 Stück in Schachtel

Hose clamps

- made of stainless steel
- in box of 100 pieces



Bestell-Nr. Order-no.	Spannbereich mm Capacity mm
29-180008-9	8-12
29-180010-9	10-16
29-180012-9	12-20
29-180016-9	16-25
29-180020-9	20-32
29-180025-9	25-40
29-180030-9	30-45
29-180032-9	32-50
29-180040-9	40-60
29-180050-9	50-70
29-180060-9	60-80

Schlauchschellen-Sortiment

- 110-teilig im Ständer
- 10 Stück je Abmessung 8-80 mm
- inklusive Schraubendreher

Hose clamp set

- with stand of 110 pieces
- 10 pieces of size 8-80 mm
- including screw driver



Bestell-Nr.
Order-no.

[29-182000-9](#)



Gummi-Elastikteller

für Winkelschleifer mit Schraube M 14

Rubber pad

with nut M 14 for grinder



Bestell-Nr. Order-no.	Ø mm Ø mm
29-185015-9	115
29-185025-9	125
29-185080-9	180

Elastikteller

für Winkelschleifer mit Schraube M 14

Pad

with nut M 14 for grinder



Bestell-Nr. Order-no.	Ø mm Ø mm
29-186015-9	115
29-186025-9	125
29-186080-9	180

Universal-Koffer

- mit Schaumstoffeinlage
- blau

Universal case

- with foam inlay
- blue



Bestell-Nr. Order-no.	Länge x Breite x Höhe mm Length x width x height mm
29-187000-0	335 x 240 x 71

Schlüsselring

- vernickelt
- Box mit 100 Stück

Key ring

- nickel plated
- box of 100 pieces



Bestell-Nr. Order-no.	Ø mm
29-190020-0	20
29-190025-0	25
29-190030-0	30
29-190035-0	35

Schlüsselanhänger

- aus Kunststoff
- mit Metall O-Ring
- 200 Stück in sortierter Verkaufsbox

Key tags

- made of plastic
- with metal O-ring
- 200 pieces in in assorted display box



Bestell-Nr. Order-no.	Farbe Colour
29-191001-0	gemischt/assorted

Schlüsselanhänger

- aus Kunststoff
- mit Metall O-Ring
- 100 Stück in Schachtel

Key tags

- made of plastic
- with metal O-ring
- box of 100 pieces



Bestell-Nr. Order-no.	Farbe Colour
29-191000-0	gemischt/assorted
29-192000-0	neon gemischt/neon assorted

Schlüsselanhänger

- aus Kunststoff
- mit Metall S-Ring
- 100 Stück in Schachtel

Key tags

- made of plastic
- with metal S-ring
- box of 100 pieces



Bestell-Nr. Order-no.	Farbe Colour
29-193000-0	gemischt/assorted
29-194000-0	neon gemischt/neon assorted



Bodenträgerschienen

- Lochabstand 98 mm
- Lochdurchmesser 3,25 mm
- Schlitzabstand 14 mm
- Schlitzabmessung 10 x 3 mm

U-rails

- hole distance 98 mm
- hole Ø 3,25 mm
- slot distance 14 mm
- slot size 10 x 3 mm

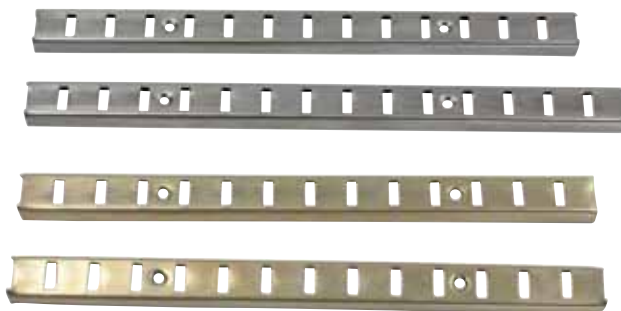

Bestell-Nr. Order-no.	Material material	Länge mm length mm
29-197035-0	Eisen vernickelt/iron nickel plated	3.500
29-197050-0	Eisen vernickelt/iron nickel plated	5.000
29-197135-0	Eisen vermessingt / iron brassed	3.500
29-197150-0	Eisen vermessingt / iron brassed	5.000

Kunststoff-Bodenträger

- mit Stift
- 1.000 Stück im Karton

Bottom carrier

- with nail
- box of 1.000 pieces



Bestell-Nr. Order-no.	Farbe Colour
29-196001-9	weiß/white
29-196002-9	schwarz/black
29-196003-9	braun/dark brown
29-196004-9	buche/beech
29-196005-9	eiche/oak

Bodenträger

- 16 mm
- 100 Stück im Karton

Brackets for U-rails

- 16 mm
- 100 pieces in box



Bestell-Nr. Order-no.	Material material
29-197200-0	Eisen vernickelt/iron nickel plated
29-197201-0	Eisen vermessingt/iron brassed

Türstopper aus Gummi

rot/orange

Door buffer

red/orange



Bestell-Nr. Order-no.	Abmessung mm Dimension mm
29-199000-0	30 x 26

Rollfeder

- gebläut
- 500 Stück in Schachtel

Volute spring

- blue
- box of 500 pieces



Bestell-Nr. Order-no.	Abmessung mm Dimension mm
29-205050-0	50
29-205060-0	60
29-205070-0	70
29-205075-0	75

Taschenfederwaage

mit vermessingtem Ziffernblatt

Pocket balance

with brassed face



Bestell-Nr. Order-no.	Kapazität kg Capacity kg
29-200010-0	10,0
29-200012-0	12,5
29-200015-0	15,0
29-200020-0	20,0
29-200025-0	25,0
29-200030-0	30,0
29-200040-0	40,0
29-200050-0	50,0
29-200075-0	75,0
29-200100-0	100,0
29-200150-0	150,0

Schafschere

- geschmiedet
- gerade Ausführung

Sheep shear

- forged
- straight pattern



Bestell-Nr. Order-no.	Länge Zoll Length inch	Detail Detail
29-207011-0	11	Rundfeder/simple bow
29-207012-0	12	Rundfeder/simple bow
29-207511-0	11	Herzfeder/double bow
29-207512-0	12	Herzfeder/double bow

Rattenfalle

- aus Eisenblech
- vermessingt

Rat trap

- made of iron steel
- brassed



Bestell-Nr.
Order-no.

29-211000-0

Abmessung mm
Dimension mm

165 x 90

Rattenfalle

- aus Holz
- Type LUNA
- mit Holzwippe und Köderbügel

Rat trap

- made of wood
- type LUNA



Bestell-Nr.
Order-no.

29-212000-0

Abmessung mm
Dimension mm

168 x 86

Mausefalle

- aus Holz
- Type LUNA
- mit Holzwippe und Köderbügel

Mouse trap

- made of wood
- type LUNA

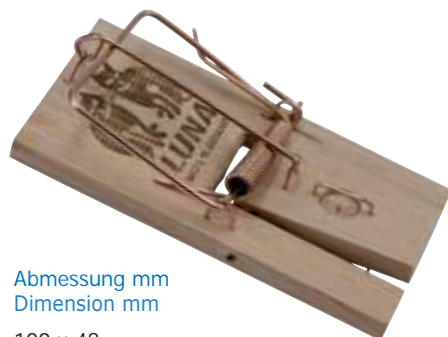

Bestell-Nr.
Order-no.

29-214000-0

Abmessung mm
Dimension mm

100 x 48

Mausefalle

- aus Metall
- Type KILLER

Mouse trap

- made of metal
- type KILLER



Bestell-Nr.
Order-no.

29-215000-0

Abmessung mm
Dimension mm

100 x 55

Rattenfalle

- aus Metall
- Type KILLER

Rat trap

- made of metal
- type KILLER



Bestell-Nr.
Order-no.

29-213000-0

Abmessung mm
Dimension mm

170 x 90

Raubtierfalle - Typ KILLER

- mit Blattfeder aus Spezialstahl
- mit gezahnten Bügeln
- stabile Kette mit Ring
- lackiert

Animal trap - type KILLER

- with spring made of special steel
- with toothed bow frame
- with chain and ring
- varnished

Bestell-Nr.
Order-no.

29-215503-0

Bügelweite Zoll - mm
bow width inch - mm

3- 75

29-215504-0

4-100

29-215505-0

5-125

29-215506-0

6-150

29-215507-0

7-175

29-215508-0

8-200

Haushalt-Tauchsieder

- Eintauchtiefe 140 mm
- 3-adrig
- 0,8 Meter Kabel
- 230 Volt

Immersion heater

- depth of immersion 140 mm
- 3-core
- 0,8 meter cable
- 230 Volt



Bestell-Nr.	Watt
Order-no.	Watts
29-220001-0	1.000

Reise-Tauchsieder

- mit Becher
- im Etui
- 3-adrig
- 1 Meter Kabel
- 230 Volt

Immersion travel heater

- with cup
- in zipper bag
- 3-core
- 1 meter cable
- 230 Volt



Bestell-Nr.	Watt
Order-no.	Watts
29-221000-0	350

Haushalt-Tauchsieder

- Eintauchtiefe 220 mm
- 3-adrig
- 1 Meter Kabe
- 230 Volt

Immersion heater

- depth of immersion 220 mm
- 3-core
- 1 meter cable
- 230 Volt



Bestell-Nr.	Watt
Order-no.	Watts
29-220002-0	2.000



Dachdecker-Spezialzange

- Kopf plan geschliffen
- rot lackiert
- feine Wate

Special tiler pincer

- head flat grinded
- red japanned

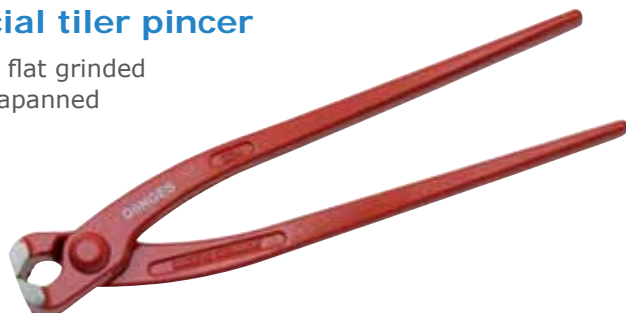

Bestell-Nr.
Order-no.

21-380000-0

Länge mm
Length mm

220

**Dachdecker-Beißzange**

- Kopf plan geschliffen
- rot lackiert
- feine Wate

Special tiler pincer

- head flat grinded
- red japanned



Bestell-Nr.
Order-no.

21-381000-0

Länge mm
Length mm

220

Dachdecker-Nagel-/Flickeisen

- mit Nagelklaue am Griff
- handgeschmiedet

Slate ripper

- nail claw on the handle
- hand-forged



Bestell-Nr.
Order-no.

29-250000-0

Länge mm
Length mm

470

Rinnenhalter-Biegezange mit Rolle

- Kopf chromatisiert
- Schenkel rot lackiert
- mit schwarzen Handgriffen
- für Rinnen bis 8 mm Stärke und 50 mm Breite

Eaves gutter bending pliers

- tubes red japanned
- black handles
- for gutter with up to 8 mm thickness and 50 mm widthness

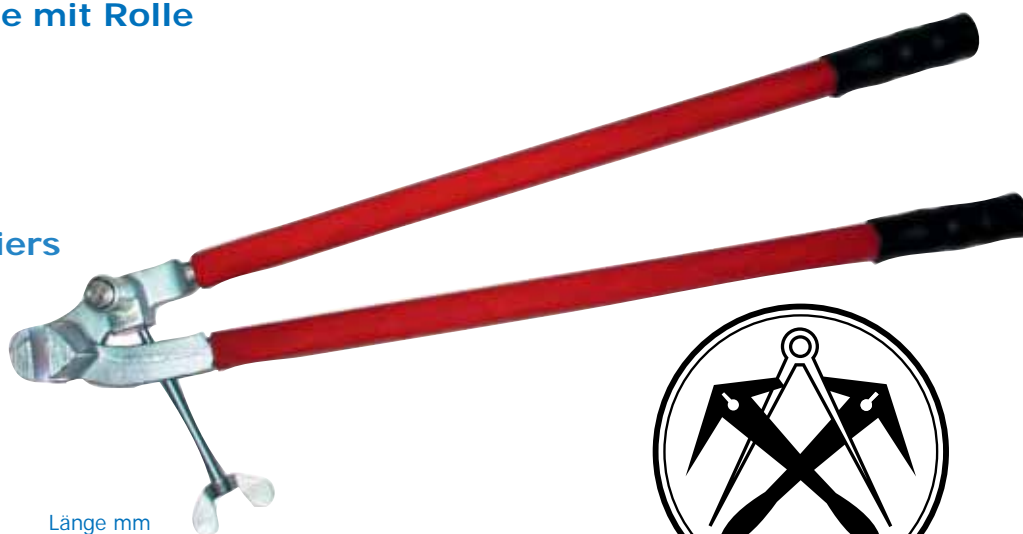

Bestell-Nr.
Order-no.

21-390070-0

Länge mm
Length mm

700





**Scheren**

Metallscheren	276-281
Kabelscheren	281
Betonstahlscheren	283

Shears

Metal shears	276-281
Cable shears	281
Steel cutting shears	283

**Spannen/Befestigen**

Feilkloben	282-283
Schraubstöcke	302
Schraubzwingen	302-303
Haken/Wirbel/Schäkel	339-340
Klemmen	340
Kartuschenpistolen	341
Dübel/Nägeln/Haken	300, 346-347
Keile	347

Tensioning/Fixing

Vices	282-283
steel vices	302
Screw clamps	302-303
Hooks/Swivels/Shakle	339-340
Clamps	340
Caulking guns	341
Anchors/Nails/Hooks	300, 346-347
Wedges	347

**Hämmer**

Schlosserhammer	284-285
Kupferhammer	285
Fäustel/Vorschlaghammer	286-287
Latthammer	288
Ausbeulhammer	289
Gummi-/Holzhammer	289

Hammers

Machinist's hammers	284-285
Copper hammers	285
Sledge hammers	286-287
Roofing hammers	288
Ball pane hammer	289
Rubber-/Woodhammer	289

**Schlagwerkzeuge**

Lochisen	290-291
Zentrierwerkzeuge	291-294
Meißel	295-298
Setzisen	301
Schlagstempel	336-337

Punching tools

Punches	290-291
Centre tools	291-294
Chisels	295-298
Setters	301
Steel punch sets	336-337

**Löten/Schweißen**

LötKolben	304-307, 310
Löt draht/-stange	308-309
Zubehör	310-315, 326
Gripzangen	326-328
Jumbo Regler	316

Soldering/Welding

Soldering Irons	304-307, 310
Soldering wire/-rods	308-309
Accessories	310-315, 326
Grip Pliers	326-328
Jumbo Regulators	316

**Schleifen/Trennen**

Schleifmaterial	329-331
	335, 342
Trennscheiben	333-335

Grinding/Cutting

Grinding discs/wheels	329-331
	335, 342
Cutting discs	333-335

**Sonstiges**

Schaber	298-299
Klebepistole	308
Sicherheitsausrüstung	317-322, 343
Hand-/Arbeitsbürsten	323-325
Signierschablonen	338
Fettpresse	342
Schlossriegel	343
Schmiedezangen	344-345

Others

Scrapers	298-299
Glue gun	308
Safety equipment	317-322, 343
Hand-/Working brushes	323-325
Stencil plates	338
Grease gun	342
Door bolt	343
Tinner's/Blacksmith's pliers	344-345

Blechscher PELIKAN

- Schneide induktiv gehärtet
- Griffe PVC-getaucht

Sheet cutting shear PELIKAN

- cutting edge inductive hardened
- handles PVC insulated



Bestell-Nr. Order-no.	Schneide Cutting	Länge mm Length mm
30-101030-0	rechts/right	300
30-101035-0	rechts/right	350
30-101530-0	links/left	300

linke Schneide/
left cuttingrechte Schneide/
right cutting**Blechscher IDEAL**

- Schneide induktiv gehärtet
- rechtsschneidend
- Griffe PVC-getaucht

Tinmen's shear IDEAL

- cutting edge inductive hardened
- right cutting
- handles PVC insulated



Bestell-Nr. Order-no.	Länge mm Length mm
30-103026-0	260
30-103028-0	280

Blechscher IDEAL

- Schneide induktiv gehärtet
- linksschneidend
- Griffe PVC-getaucht

Tinmen's shear IDEAL

- cutting edge inductive hardened
- left cutting
- handles PVC insulated



Bestell-Nr. Order-no.	Länge mm Length mm
30-104026-0	260
30-104028-0	280

Figuren-Loch-Blechscher

- Schneide induktiv gehärtet
- rechtsschneidend
- Griffe PVC-getaucht

Figures sheet shear

- cutting edge inductive hardened
- right cutting
- handles PVC insulated



Bestell-Nr.
Order-no.

30-106025-0

Länge mm
Length mm

250

Loch-Blechscher

- Schneide induktiv gehärtet
- rechtsschneidend
- Griffe PVC-getaucht

Hole sheet cutting shear

- cutting edge inductive hardened
- right cutting
- handles PVC insulated



Bestell-Nr.
Order-no.

30-109025-0

30-109027-0

30-109030-0

Länge mm
Length mm

250

275

300

Figuren-Loch-Blechscher

- Schneide induktiv gehärtet
- linksschneidend
- Griffe PVC-getaucht

Figures sheet shear

- cutting edge inductive hardened
- left cutting
- handles PVC insulated



Bestell-Nr.
Order-no.

30-107025-0

Länge mm
Length mm

250

Loch-Blechscher

- Schneide induktiv gehärtet
- linksschneidend
- Griffe PVC-getaucht

Hole sheet cutting shear

- cutting edge inductive hardened
- left cutting
- handles PVC insulated



Bestell-Nr.
Order-no.

30-110025-0

30-110027-0

30-110030-0

Länge mm
Length mm

250

275

300

Amerikanische Bleischere

- Schneide induktiv gehärtet
- mit Schraube
- Griffe PVC-getaucht

Tinmen's shear

- american type
- cutting edge inductive hardened
- with screw
- handles PVC insulated



Bestell-Nr. Order-no.	Länge mm Length mm
30-112020-0	200
30-112025-0	250
30-112030-0	300
30-112035-0	350

Figuren-Bleischere

- hebelübersetzt
- selbstöffnend
- für Blechstärke bis 1,2 mm
- mit Mikroverzahnung
- gerade

Combination sheet shear

- lever transmission
- self opening
- for normal sheet cutting up to 1,2 mm
- micro tothing
- straight cutting



Bestell-Nr. Order-no.	Länge mm Length mm
30-114024-0	240

**Figuren-Bleischere**

- hebelübersetzt
- selbstöffnend
- für Blechstärke bis 1,2 mm
- mit Mikroverzahnung
- rechtsschneidend

Combination sheet shear

- lever transmission
- self opening
- for normal sheet cutting up to 1,2 mm
- micro tothing
- right cutting



Bestell-Nr. Order-no.	Länge mm Length mm
30-114124-0	240

Figuren-Blechscher

- hebelübersetzt
- selbstöffnend
- für Blechstärke bis 1,2 mm
- mit Mikroverzahnung
- linksschneidend

Combination sheet shear

- lever transmission
- self opening
- for normal sheet cutting up to 1,2 mm
- micro toothing
- left cutting



Bestell-Nr.
Order-no.

30-114224-0

Länge mm
Length mm

240

Durchlaufschere IDEAL

- hebelübersetzt
- selbstöffnend
- für Blechstärke bis 1,2 mm
- mit Mikroverzahnung
- linksschneidend

Shear passing sheet IDEAL

- lever transmission
- self opening
- for normal sheet cutting up to 1,2 mm
- micro toothing
- left cutting



Bestell-Nr.
Order-no.

30-117026-0

Länge mm
Length mm

260

Durchlaufschere IDEAL

- hebelübersetzt
- selbstöffnend
- für Blechstärke bis 1,2 mm
- mit Mikroverzahnung
- rechtsschneidend

Shear passing sheet IDEAL

- lever transmission
- self opening
- for normal sheet cutting up to 1,2 mm
- micro toothing
- right cutting



Bestell-Nr.
Order-no.

30-116026-0

Länge mm
Length mm

260

Englische Blechscher

- mit Schraube und Feder
- lackiert
- mit Lederband

Tinmen's shear

- english pattern
- with spring and screw
- with leather band



Bestell-Nr.
Order-no.

30-122020-0

Länge mm
Length mm

200

30-122025-0

250

30-122030-0

300

Goldschmiede-Schere

- mit Griffaugen
- polierte Schneide
- lackiert

Jeweller's snip

- with round eye handle
- polished blade
- japanned



Bestell-Nr. Order-no.	Länge mm Length mm	Ausführung Execution
30-130018-0	180	gerade/straight
30-131018-0	180	gebogen/bent

Kombi-Schere

- gerade
- Klinge rostfrei
- für:
 - weichen Draht
 - Stoff
 - Kunststoff
 - Leder
 - Teppich
 - Papier
 - Gartenarbeiten etc.

All purpose scissors

- made of stainless steel
- straight
- useable for:
 - soft wire
 - cloth
 - pvc
 - leather
 - carpet
 - paper etc.



Bestell-Nr. Order-no.	Länge mm Length mm
30-143015-0	150
30-143019-9	190

Goldschmiede-Schere

- geschlossen
- polierte Schneide
- lackiert

Jeweller's snip

- handle closed
- polished blade
- japanned



Bestell-Nr. Order-no.	Länge mm Length mm	Ausführung Execution
30-140018-0	180	gerade/straight
30-141018-0	180	gebogen/bent



Kabel-Schere

- Klinge rostfrei
- für Kabelquerschnitte bis \varnothing 10 mm
- mit Feder
- selbstöffnend
- mit praktischem Verschluss

Cable scissors

- blade made of stainless steel
- for cable profile up to \varnothing 10 mm
- with spring
- self opening



Bestell-Nr.
Order-no.
30-145016-0

Länge mm
Length mm
160

Telefon- und Kabelschere

- mit Drahtabschneider
- Klinge gezahnt
- vernickelt

Cable scissors

- with wire cutter
- blade toothed
- nickel plated



Bestell-Nr.
Order-no.
30-146012-0

Länge mm
Length mm
125



Feinmechaniker-Feilklöbchen

- Backen spitz
- polierte Ausführung

Jeweller's hand vice

- narrow jaws
- all polished

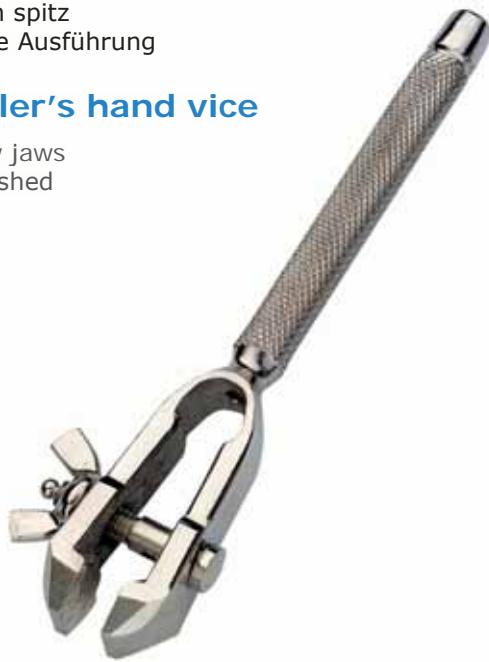

Bestell-Nr. Order-no.	Länge mm Length mm	Backenbreite mm Jaw width mm
30-150011-0	115	8

Installateur-Feilklobe

- Backen seitlich abgerundet
- geeignet zum Biegen von Rohren
- mit Drehgriff

Plumber's hand vice

- useable for tube bending
- with crank

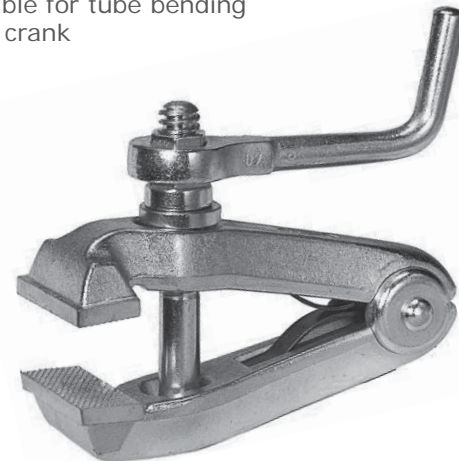

Bestell-Nr. Order-no.	Länge mm Length mm	Backenbreite mm Jaw width mm	Spannweite mm Opening mm
30-154020-0	200	85	55

Feinmechaniker-Feilklöbchen

- Backen breit
- polierte Ausführung

Jeweller's hand vice

- wide jaws
- all polished

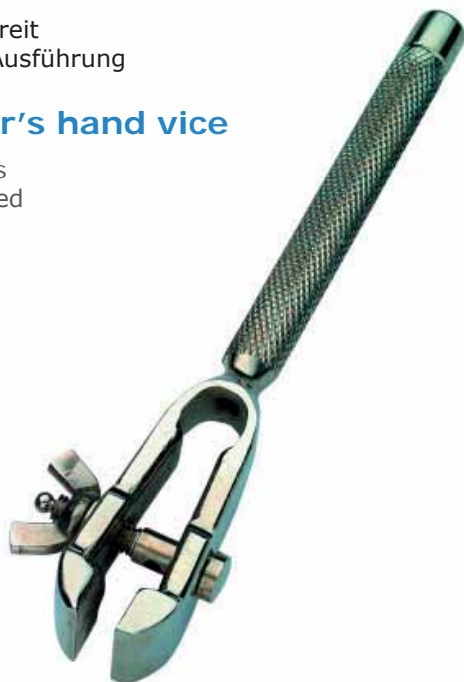

Bestell-Nr. Order-no.	Länge mm Length mm	Backenbreite mm Jaw width mm
30-152011-0	115	16
30-152013-0	130	20

Doppelstarke Feilklobe

- verzinkte Ausführung
- mit Drehgriff

Hand vice

- galvanized
- with wide jaws and crank



Bestell-Nr. Order-no.	Länge mm Length mm	Backenbreite mm Jaw width mm	Spannweite mm Opening mm
30-155014-0	145	50	35
30-155016-0	160	58	40
30-155018-0	180	62	45
30-155020-0	200	65	55

Hand-Feilklobe

- verzinkte Ausführung
- mit breiten Backen
- mit Flügelschraube

Hand vice

- galvanized
- with wide jaws
- with wing bolt

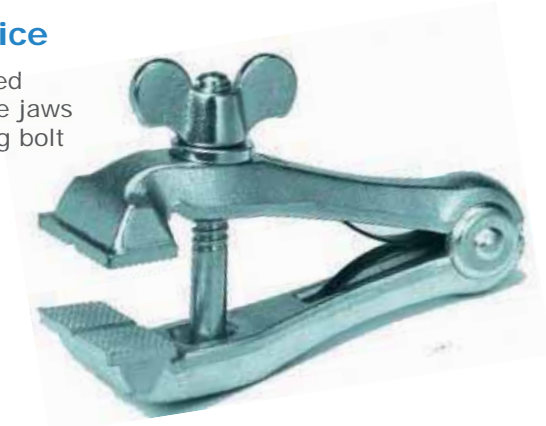

Bestell-Nr. Order-no.	Länge mm Length mm	Backenbreite mm Jaw width mm	Spannweite mm Opening mm
30-156008-0	85	32	16
30-156010-0	100	36	18
30-156012-0	120	40	22
30-156013-0	130	42	25
30-156014-0	145	50	28
30-156016-0	160	52	30
30-156018-0	180	55	35
30-156020-0	200	62	40

Hand-Feilklobe

- verzinkte Ausführung
- mit spitzen Backen
- mit Flügelschraube

Hand vice

- galvanized
- with narrow jaws
- with wing bolt



Bestell-Nr. Order-no.	Länge mm Length mm	Backenbreite mm Jaw width mm	Spannweite mm Opening mm
30-157010-0	100	12	18
30-157013-0	130	14	20
30-157015-0	150	16	28

Betonstahlblechscherer VITTE

zum Schneiden von verschiedenem Stahlmaterial

Reinforcement steel cutting shear VITTE

useable for cutting of various steel materials

Bestell-Nr. Order-no.	VITTE Nr. VITTE No.
30-165522-0	50 N/22
30-165528-0	50 N/28
30-165532-0	50 N/32
30-165022-0	50 N/22-Ersatzmesser/spare knife
30-165028-0	50 N/28-Ersatzmesser/spare knife
30-165032-0	50 N/32-Ersatzmesser/spare knife

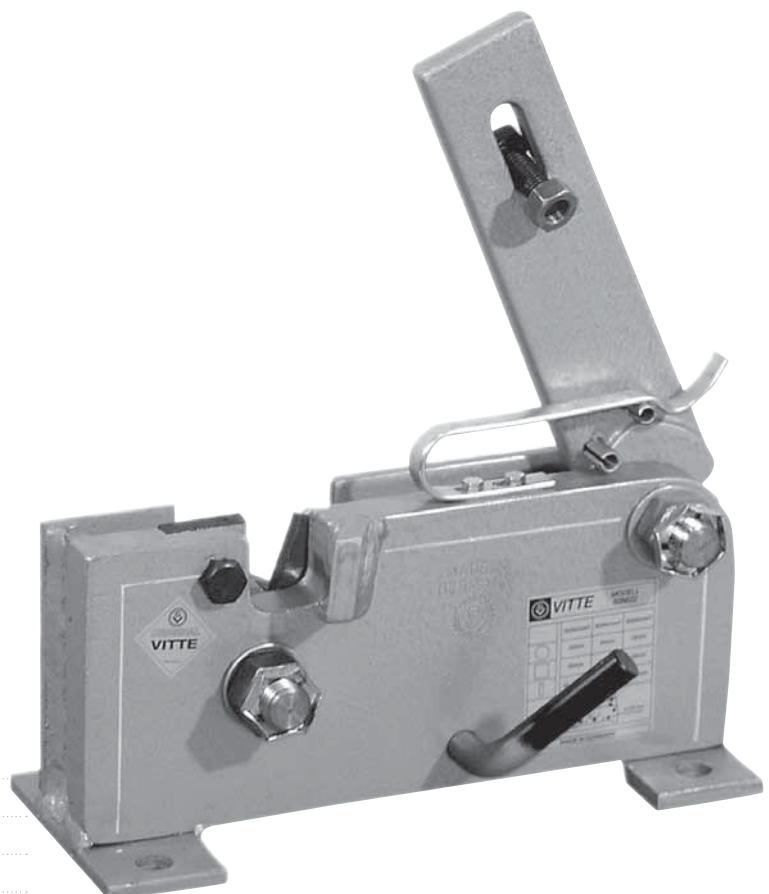

Schlosserhammer PRIMA

mit Holzstiel

Machinist's hammer

with wooden handle



Bestell-Nr. Order-no.	Gewicht g Weight g
30-170001-9	100
30-170002-9	200
30-170003-9	300
30-170004-9	400
30-170005-9	500

Bestell-Nr. Order-no.	Gewicht g Weight g
30-170008-9	800
30-170010-9	1.000
30-170015-9	1.500
30-170020-9	2.000

**Schlosserhammer
DIN 1041**

- mit Stielschutzhülle
- TÜV/GS-geprüft
- sauber geschliffen
- mit Hickory-Stiel

**Machinist's hammer
DIN 1041**

- with handle guard
- TÜV/GS approval
- with hickory handle

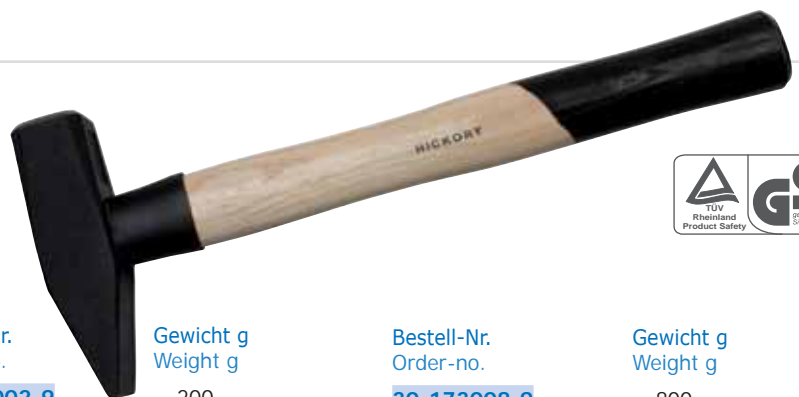

Bestell-Nr. Order-no.	Gewicht g Weight g
30-173002-9	200
30-173003-9	300
30-173005-9	500

Bestell-Nr. Order-no.	Gewicht g Weight g
30-173008-9	800
30-173010-9	1.000
30-173015-9	1.500
30-173020-9	2.000



Schlosserhammer DIN 1041

- mit lackiertem Eschenstiel
- TÜV/GS-geprüft

Machinist's hammer DIN 1041

- with ash wood handle
- TÜV/GS approval



Bestell-Nr. Order-no.	Gewicht g Weight g	Bestell-Nr. Order-no.	Gewicht g Weight g
30-174001-0	100	30-174006-0	600
30-174002-0	200	30-174008-0	800
30-174003-0	300	30-174010-0	1.000
30-174004-0	400	30-174015-0	1.500
30-174005-0	500	30-174020-0	2.000

Kupferhammer

- mit Bahn & Finne-Hammerform
- mit Eschenstiel

Copper hammer

- flat and pointed
- with ash wood handle



Bestell-Nr. Order-no.	Gewicht g Weight g	Bestell-Nr. Order-no.	Gewicht g Weight g
30-175020-0	200	30-175060-0	600
30-175025-0	250	30-175075-0	750
30-175030-0	300	30-175080-0	800
30-175040-0	400	30-175100-0	1.000
30-175050-0	500		

Kupferhammer

- flach-Fäustelform
- mit Eschenstiel

Copper hammer

- flat-sledge type
- with ash wood handle



Bestell-Nr. Order-no.	Gewicht g Weight g	Bestell-Nr. Order-no.	Gewicht g Weight g
30-177025-0	250	30-177100-0	1.000
30-177030-0	300	30-177125-0	1.250
30-177050-0	500	30-177150-0	1.500
30-177075-0	750	30-177200-0	2.000
30-177080-0	800		

Esche-Hammerstiel

- doppelt geschweift
- Form Y

Ash wood handle

for machinist's hammer



Bestell-Nr. Order-no.	Länge mm Length mm	für Hammer g for hammer g
30-179026-0	260	100
30-179028-0	280	200
30-179030-0	300	300
30-179031-0	310	400
30-179032-0	320	500
30-179033-0	330	600
30-179035-0	350	800
30-179036-0	360	1.000
30-179038-0	380	1.500
30-179040-0	400	2.000

Fäustel DIN 6475

- mit Stielschutz
- TÜV/GS-geprüft
- mit Hickory-Stiel

Sledge hammer DIN 6475

- with safety collar
- TÜV/GS approval
- with hickory handle



Bestell-Nr. Order-no.	Gewicht g Weight g
30-182010-9	1.000
30-182012-9	1.250
30-182015-9	1.500
30-182020-9	2.000

Fäustel

- STANDARD-Qualität
- mit Eschenstiel

Sledge hammer

- STANDARD quality
- with ash wood handle



Bestell-Nr. Order-no.	Gewicht g Weight g
30-180010-9	1.000
30-180012-9	1.250
30-180015-9	1.500
30-180020-9	2.000

Fäustel DIN 6475

- mit lackiertem Eschenstiel
- TÜV/GS-geprüft

Sledge hammer DIN 6475

- with ash wood handle
- TÜV/GS approval



Bestell-Nr. Order-no.	Gewicht g Weight g
30-185010-0	1.000
30-185012-0	1.250
30-185015-0	1.500
30-185020-0	2.000



Vorschlaghammer DIN 1042

- mit Eschenholzstiel

Sledge hammer DIN 1042

- with ash wood handle



Bestell-Nr. Order-no.	Gewicht kg Weight kg	Stiellänge mm Handle length mm
30-190003-9	3	600
30-190004-9	4	700
30-190005-9	5	800
30-190006-9	6	800
30-190008-9	8	900
30-190010-9	10	900

Esche-Hammerstiel

für Fäustel

Ash wood handle

for Sledge hammer



Bestell-Nr. Order-no.	Länge mm Length mm	für Hammer g for hammer g
30-189026-0	260	1.000/1.250
30-189028-0	280	1.500
30-189030-0	300	2.000

Vorschlaghammerstiel DIN 5112

- aus Eschenholz

Ash wood handle DIN 5112

- for Sledge hammer
- long type



Bestell-Nr. Order-no.	für Hammer kg for hammer kg	Länge mm Length mm
30-191060-0	3	600
30-191070-0	4	700
30-191080-0	5 + 6	800
30-191090-0	8 + 10	900

Latthammer DIN 7239

- TÜV/GS-geprüft
- mit magnetischer Nagelrinne und gerauter Bahn
- Ganzstahlstiel
- mit gummiertem Griff

Roofing hammer DIN 7239

- TÜV/GS approval
- with magnetic nail groove
- all steel shank
- rubber handle



Bestell-Nr.
Order-no.

30-210060-9

Gewicht g
Weight g

600

**Latthammer**

- mit magnetischer Nagelrinne
- Stahlrohrstiel und Nagelzieher
- mit gummiertem Griff

Roofing hammer

- with magnetic nail groove
- with round metal tube
- rubber handle



Bestell-Nr.
Order-no.

30-212060-9

Gewicht g
Weight g

600

Gipserbeil

- mit Stahlrohrstiel und Nagelzieher
- mit gummiertem Griff

Gypsum hatchet

- with steel-tube shaft
- rubber handle



Bestell-Nr.
Order-no.

30-215060-9

Gewicht g
Weight g

600

Ausbeulhammer

- mit Kugelkopf
- mit Holzstiel

Ball pane hammer

with wooden handle

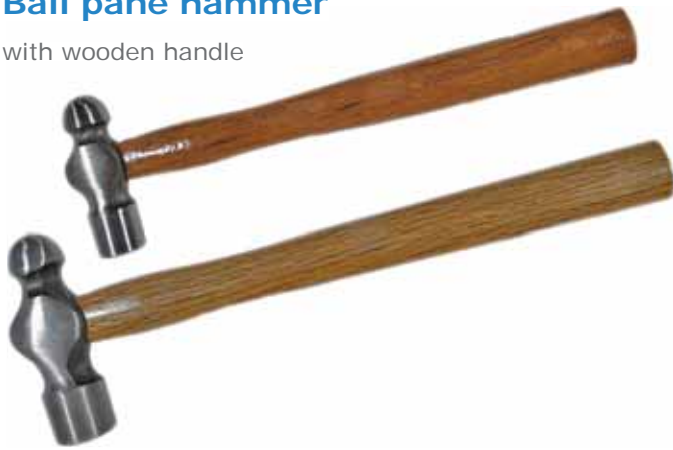

Bestell-Nr.
Order-no.

30-218034-9

30-218068-9

Gewicht
Weight

3/4 lb-340 g

1 1/2 lb-680 g

Gummihammer, weiß

- beide Seiten gerade
- mit Eschenstiel

Rubber mallet, white

- both sides straight
- ash wood handle



Bestell-Nr.
Order-no.

30-220164-9

Gummi Ø x Breite mm
Rubber Ø x width mm

64 x 113

Größe
Size

2

Gummihammer

- beide Seiten gerade
- mit Eschenstiel

Rubber mallet

- both sides straight
- ash wood handle



Bestell-Nr.
Order-no.

30-220040-9

30-220054-9

30-220064-9

30-220074-9

30-220090-9

Gummi Ø x Breite mm
Rubber Ø x width mm

40 x 80

54 x 90

64 x 113

74 x 127

90 x 139

Größe
Size

0

1

2

3

4

Holzhammer

mit Eschenstiel

Wooden hammer

ash wood handle



Bestell-Nr.
Order-no.

30-222040-0

30-222050-0

30-222060-0

30-222070-0

30-222080-0

Kopf Ø mm
Head Ø mm

40

50

60

70

80

Henkellocheisen

- nach DIN 7200A
- rot lackiert

Arch punch

- accord. to DIN 7200A
- red coated



Bestell-Nr. Order-no.	Loch Ø mm Hole Ø mm	Bestell-Nr. Order-no.	Loch Ø mm Hole Ø mm
30-240001-0	1	30-240028-0	28
30-240002-0	2	30-240029-0	29
30-240003-0	3	30-240030-0	30
30-240004-0	4	30-240031-0	31
30-240005-0	5	30-240032-0	32
30-240006-0	6	30-240033-0	33
30-240007-0	7	30-240034-0	34
30-240008-0	8	30-240035-0	35
30-240009-0	9	30-240036-0	36
30-240010-0	10	30-240037-0	37
30-240011-0	11	30-240038-0	38
30-240012-0	12	30-240039-0	39
30-240013-0	13	30-240040-0	40
30-240014-0	14	30-240041-0	41
30-240015-0	15	30-240042-0	42
30-240016-0	16	30-240043-0	43
30-240017-0	17	30-240044-0	44
30-240018-0	18	30-240045-0	45
30-240019-0	19	30-240046-0	46
30-240020-0	20	30-240047-0	47
30-240021-0	21	30-240048-0	48
30-240022-0	22	30-240049-0	49
30-240023-0	23	30-240050-0	50
30-240024-0	24		
30-240025-0	25	30-2400...-0	Weitere Abmessungen auf Anfrage/ Other sizes on request
30-240026-0	26		
30-240027-0	27		

Henkellocheisensatz

- nach DIN 7200A
- in Rolltasche

Arch punch set

- accord. to DIN 7200A
- in plastic wallet



Bestell-Nr. Order-no.	Teile/Satz Pieces/Set	Inhalt mm Content mm
30-241025-0	12	3-25 (3, 5, 7, 8, 10, 12, 13, 14, 16, 19, 22, 25)
30-241020-0	19	2-20 (2, 3, 4, 5, 6, 7, 8, 9, 10, 11, 12, 13, 14, 15, 16, 17, 18, 19, 20)
30-2410...-0		Weitere Zusammenstellungen auf Anfrage/ Other sets with different sizes on request



Runde Locheisen

- nach DIN 7200B
- rot lackiert

Hollow punch

- accord. to DIN 7200B
- red coated



Bestell-Nr. Order-no.	Loch Ø mm Hole Ø mm	Bestell-Nr. Order-no.	Loch Ø mm Hole Ø mm
30-243001-0	1	30-243014-0	14
30-243002-0	2	30-243015-0	15
30-243003-0	3	30-243016-0	16
30-243004-0	4	30-243017-0	17
30-243005-0	5	30-243018-0	18
30-243006-0	6	30-243019-0	19
30-243007-0	7	30-243020-0	20
30-243008-0	8	30-243021-0	21
30-243009-0	9	30-243022-0	22
30-243010-0	10	30-243023-0	23
30-243011-0	11	30-243024-0	24
30-243012-0	12	30-243025-0	25
30-243013-0	13		

Körner

- aus 8-kant Werkzeugstahl
- einbrennlackiert
- Spitze geschliffen

Centre punch

- octagonal shank
- special tool steel
- stove-enamelled
- polished point



Bestell-Nr. Order-no.	Länge x Ø mm Length x Ø mm
30-250001-0	100 x 10
30-250002-0	120 x 10
30-250003-0	120 x 12
30-250004-0	150 x 12

Rundlocheisensatz

- nach DIN 7200B
- in Rolltasche

Hollow punch set

- accord. to DIN 7200B
- in plastic wallet



Bestell-Nr. Order-no.	Teile/Satz Pieces/Set	Inhalt mm Content mm
30-244009-0	9	2-10 (2, 3, 4, 5, 6, 7, 8, 9, 10)
30-244010-0	10	3-25 (3, 5, 7, 8, 10, 13, 16, 19, 22, 25)
30-2400...	Weitere Zusammenstellungen auf Anfrage/Other sets with diff. Sizes on request	

Körner

- aus Werkzeuggrundstahl
- einbrennlackiert
- Spitze geschliffen

Centre punch

- round shank
- special tool steel
- stove-enamelled
- polished point



Bestell-Nr. Order-no.	Länge x Ø mm Length x Ø mm
30-251001-0	100 x 8
30-251002-0	100 x 10
30-251003-0	120 x 10
30-251004-0	120 x 12
30-251005-0	150 x 12

Körner DIN 7250

- 8-kant
- lackiert
- Chrom-Vanadium

Centre punch DIN 7250

- octagonal
- varnished
- Chrom-Vanadium



Bestell-Nr. Order-no.	Länge x Ø mm Length x Ø mm
30-252008-0	100 x 8
30-252010-0	120 x 10
30-252012-0	120 x 12
30-252015-0	150 x 12
30-252016-0	150 x 16
30-252018-0	180 x 16

Durchschläger

- aus 8-kant Werkzeugstahl
- einbrennlackiert
- Spitze geschliffen

Nail set

- octagonal shank
- special tool steel
- stove-enamelled
- polished point



Bestell-Nr. Order-no.	Länge x Ø x Spitze Ø mm Length x Ø x point Ø mm
30-255001-0	120 x 10 x 1
30-255002-0	120 x 10 x 2
30-255003-0	120 x 10 x 3
30-255004-0	120 x 10 x 4
30-255005-0	120 x 10 x 5
30-255006-0	120 x 10 x 6

Durschschläger

- aus Werkzeuggrundstahl
- einbrennlackiert
- Spitze geschliffen

Nail set

- round shank
- special tool steel
- stove-enamelled
- polished point



Bestell-Nr. Order-no.	Länge x Ø x Spitze Ø mm Length x Ø x point Ø mm
30-254001-0	100 x 8 x 1
30-254002-0	100 x 8 x 2
30-254003-0	100 x 8 x 3
30-254004-0	100 x 8 x 4
30-254101-0	100 x 10 x 1
30-254102-0	100 x 10 x 2
30-254103-0	100 x 10 x 3
30-254104-0	100 x 10 x 4
30-254105-0	100 x 10 x 5
30-254106-0	100 x 10 x 6
30-254201-0	120 x 10 x 1
30-254202-0	120 x 10 x 2
30-254203-0	120 x 10 x 3
30-254204-0	120 x 10 x 4
30-254205-0	120 x 10 x 5
30-254206-0	120 x 10 x 6

Durchschläger DIN 6458

- 8-kant
- lackiert
- Chrom-Vanadium

Nail set DIN 6458

- octagonal
- varnished
- Chrom-Vanadium



Bestell-Nr. Länge x Ø x Spitze Ø mm
Order-no. Length x Ø x point Ø mm

30-255901-0	100 x 8 x 1
30-255902-0	100 x 8 x 2
30-255903-0	100 x 8 x 3
30-255904-0	100 x 8 x 4
30-255905-0	100 x 8 x 5

30-256001-0	120 x 10 x 1
30-256002-0	120 x 10 x 2
30-256003-0	120 x 10 x 3
30-256004-0	120 x 10 x 4
30-256005-0	120 x 10 x 5
30-256006-0	120 x 10 x 6

30-256101-0	120 x 12 x 1
30-256102-0	120 x 12 x 2
30-256103-0	120 x 12 x 3
30-256104-0	120 x 12 x 4
30-256105-0	120 x 12 x 5
30-256106-0	120 x 12 x 6
30-256107-0	120 x 12 x 7
30-256108-0	120 x 12 x 8
30-256109-0	120 x 12 x 9
30-256110-0	120 x 12 x 10

30-256207-0	150 x 16 x 7
30-256208-0	150 x 16 x 8
30-256209-0	150 x 16 x 9
30-256210-0	150 x 16 x 10
30-256211-0	150 x 16 x 11
30-256212-0	150 x 16 x 12

**Durchschläger-/Körner-Satz
DIN 6458/7250**

- im Kunststoffständer
- 8-kant
- lackiert
- Chrom-Vanadium

**Nail and centre
punch set
DIN 6458/7250**

- in PVC stand
- octagonal
- varnished
- Chrom-Vanadium



Bestell-Nr. Teile/Satz Inhalt mm
Order-no. Pieces/Set Content mm

30-259012-0	6	Körner/Centre punch 120 x 12, Durchschläger/Nailer 120 x 10 x 2-3-4-5-6
-----------------------------	---	--



Splintentreiber DIN 6450

- 8-kant
- lackiert
- Chrom-Vanadium

Parallel pin punch DIN 6450

- octagonal
- varnished
- Chrom-Vanadium



Bestell-Nr. Order-no.	Länge x Ø x Spitze Ø mm Length x Ø x point Ø mm
30-263002-0	150 x 10 x 2
30-263003-0	150 x 10 x 3
30-263004-0	150 x 10 x 4
30-263005-0	150 x 10 x 5
30-263006-0	150 x 10 x 6
30-263107-0	150 x 12 x 7
30-263108-0	150 x 12 x 8
30-263109-0	150 x 12 x 9
30-263110-0	150 x 12 x 10
30-263210-0	150 x 14 x 10
30-263211-0	150 x 14 x 11
30-263212-0	150 x 14 x 12
30-263304-0	180 x 10 x 4
30-263305-0	180 x 10 x 5
30-263306-0	180 x 10 x 6
30-263406-0	180 x 12 x 6
30-263407-0	180 x 12 x 7
30-263408-0	180 x 12 x 8

**Splintentreibersatz
DIN 6450**

- im Kunststoffständer
- 8-kant
- lackiert
- Chrom-Vanadium

**Parallel pin
punch set
DIN 6450**

- in PVC stand
- octagonal
- varnished
- Chrom-Vanadium



Bestell-Nr. Order-no.	Teile/Satz Pieces/Set	Inhalt mm Content mm
30-260000-0	6	150 x 10 x 3-4-5-6/ 150 x 12 x 7-8

**Splintentreibersatz
DIN 6450**

- in Tasche 8-kant
- lackiert
- Chrom-Vanadium

**Parallel pin
punch set
DIN 6450**

- in wallet
- octagonal
- varnished
- Chrom-Vanadium



Bestell-Nr. Order-no.	Teile/Satz Pieces/Set	Inhalt mm Content mm
30-261000-0	6	150 x 10 x 3-4-5-6/ 150 x 12 x 7-8

Elektriker-/Karosserie-Schlitzmeißel DIN 7255

geeignet für die Metall und Steinbearbeitung

- lackiert
- Chrom-Vanadium

Electrician's chisel DIN 7255

useable for metal or stone work

- varnished
- Chrom-Vanadium



Bestell-Nr. Order-no.	Länge x Breite x Stärke mm Length x width x strength mm
30-267000-0	240 x 26 x 7

Elektriker-Meißel DIN 7255

für die Steinbearbeitung

- 8-kant
- lackiert
- Chrom-Vanadium

Electrician's cold chisel DIN 7255

for stone work

- octagonal
- varnished
- Chrom-Vanadium



Bestell-Nr. Order-no.	Länge x Ø x Schneide mm Length x Ø x blade mm
30-269021-0	200 x 8 x 10
30-269025-0	250 x 8 x 10
30-269030-0	300 x 10 x 12

Elektriker-/Karosserie-Schlitzmeißel DIN 7255

geeignet für die Metall und Steinbearbeitung

- Chrom-Vanadium
- lackiert
- mit Handschutz

Electrician's chisel DIN 7255

useable for metal or stone work

- with hand protector
- varnished
- Chrom-Vanadium



Bestell-Nr. Order-no.	Länge x Breite x Stärke mm Length x width x strength mm
30-268000-0	240 x 26 x 7

Steinmeißel

für die Steinbearbeitung

- Werkzeugstahl
- 8-kant
- lackiert

Stone chisel

for stone work

- drop-forged steel
- octagonal
- varnished



Bestell-Nr. Order-no.	Länge x Ø x Schneide mm Length x Ø x blade mm
30-270002-0	150 x 10 x 13
30-270003-0	150 x 12 x 16
30-270004-0	175 x 12 x 16
30-270005-0	200 x 16 x 20
30-270006-0	200 x 18 x 25
30-270007-0	250 x 16 x 20
30-270008-0	250 x 18 x 25
30-270010-0	300 x 18 x 25
30-270011-0	350 x 18 x 25
30-270012-0	400 x 18 x 25

Maurermeißel DIN 7254-B

für die Steinbearbeitung

- 8-kant
- lackiert
- Chrom-Vanadium

Stone chisel DIN 7254-B

for stone and concrete

- octagonal
- varnished
- Chrom-Vanadium



Bestell-Nr. Order-no.	Länge x Ø x Schneide mm Length x Ø x blade mm
30-271015-0	150 x 12 x 16
30-271025-0	250 x 16 x 23
30-271030-0	300 x 18 x 26
30-271035-0	350 x 18 x 26
30-271040-0	400 x 18 x 26
30-271050-0	500 x 18 x 26

**Schlossermeißel/Steinmeißel
DIN 6453/7254**

für die Metall- und Steinbearbeitung

- flach-oval
- lackiert
- Chrom-Vanadium

Cold chisel DIN 6453/7254

for metal and stone work

- flat-oval
- varnished
- Chrom-Vanadium

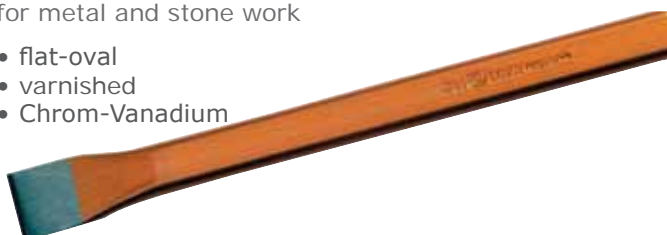

Bestell-Nr. Order-no.	Länge x Breite x Schneide mm Length x width x blade mm
30-274010-0	100 x 14 x 15
30-274012-0	125 x 14 x 15
30-274015-0	150 x 17 x 18
30-274017-0	175 x 20 x 21
30-274020-0	200 x 23 x 26
30-274025-0	250 x 23 x 26
30-274030-0	300 x 23 x 26
30-274035-0	350 x 23 x 26
30-274040-0	400 x 23 x 29
30-274050-0	500 x 26 x 31

Kreuzmeißel DIN 6451

für die Metallbearbeitung

- flach-oval
- lackiert
- Chrom-Vanadium

Cross-cut chisel DIN 6451

for metal work

- flat-oval
- varnished
- Chrom-Vanadium



Bestell-Nr. Order-no.	Abmessung mm Size mm
30-277012-0	125 x 14 x 9/5
30-277015-0	150 x 17 x 11/6
30-277017-0	175 x 20 x 12/7
30-277020-0	200 x 20 x 12/7
30-277025-0	250 x 23 x 13/9

Werkzeugsatz

- kombiniert bestehend aus:
 - Meißel
 - Körner
 - Durchschläger
- in Plastiktasche
- Chrom-Vanadium

Chisel-Punch tool set

- combined consisting of:
 - chisel
 - centre punch
 - nail set
- in wallet
- Chrom-Vanadium



Bestell-Nr.
Order-no.
30-300000-0

Teile/Satz
Pieces/Set
6

Maurer-Spitzmeißel

für die Steinbearbeitung

- 8-kant
- Werkzeugstahl
- lackiert

Pointed chisel

for stone work

- octagonal
- drop-forged steel
- varnished



Bestell-Nr.
Order-no.

Länge x Ø mm
Length x Ø mm

30-307001-0

200 x 16

30-307002-0

200 x 18

30-307003-0

250 x 18

30-307004-0

300 x 16

30-307005-0

300 x 18

30-307006-0

350 x 18

30-307007-0

400 x 18

Werkzeugsatz

- kombiniert bestehend aus:
 - Meißel
 - Körner
 - Durchschläger
- im Kunststoffhalter
- Chrom-Vanadium

Chisel-Punch tool set

- combined consisting of
 - chisel
 - centre punch
 - nail set
- in pvc stand
- Chrom-Vanadium



Bestell-Nr.
Order-no.
30-301000-0

Teile/Satz
Pieces/Set
6

Maurer-Spitzmeißel DIN 7256

für die Steinbearbeitung

- 8-kant
- lackiert
- Chrom-Vanadium

Pointed chisel DIN 7256

for stone work

- octagonal
- varnished
- Chrom-Vanadium



Bestell-Nr.
Order-no.

Länge x Ø mm
Length x Ø mm

30-308004-0

250 x 16

30-308005-0

300 x 18

30-308007-0

350 x 18

30-308009-0

400 x 18

30-308011-0

500 x 18

Fugenmeißel

- flach-oval
- lackiert
- Chrom-Vanadium

Gap chisel

- flat-oval
- varnished
- Chrom-Vanadium



Best.-Nr. Order-no.	Länge x Schneidenbreite mm Length x cutting width mm	Handschutz hand protection
30-308550-0	250 x 50	ohne/without
30-308575-0	250 x 75	ohne/without
30-308650-0	250 x 50	mit/with
30-308675-0	250 x 75	mit/with



Handschutz für Meißel

- schwarz
- gummiert

Hand protector for chisel

- black
- gummed



Bestell-Nr. Order-no.	für Meißel for chisels
30-319016-0	Ø 16 mm achtkant/octagonal
30-319018-0	Ø 18 mm achtkant/octagonal
30-319020-0	Ø 16-20 mm achtkant/octagonal + flach/flat 20 x 12-26 x 13 mm
30-319023-0	flach/flat only 23 x 13 mm

Flachschaber

mit Holzheft

Flat square scraper

with wooden handle



Bestell-Nr. Order-no.	Länge mm Length mm
30-320015-0	150
30-320017-0	175
30-320020-0	200
30-320025-0	250

Dreikant-Hohlschaber

mit Holzheft

Three square hollow ground scraper

with wooden handle



Bestell-Nr. Order-no.	Länge mm Length mm
30-321015-0	150
30-321017-0	175
30-321020-0	200
30-321025-0	250

Löffelschaber

- 2-schneidig
- mit Holzheft

Curved bearing scraper

- with 2 cutters
- with wooden handle



Bestell-Nr. Order-no.	Länge mm Length mm
30-323015-0	150
30-323017-0	175
30-323020-0	200
30-323025-0	250

Dreikant-Vollschaber

mit Holzheft

Three square flat ground scraper

with wooden handle



Bestell-Nr. Order-no.	Länge mm Length mm
30-322015-0	150
30-322017-0	175
30-322020-0	200
30-322025-0	250

Löffelschaber

- 3-schneidig
- mit Holzheft

Curved bearing scraper

- with 3 cutters
- with wooden handle



Bestell-Nr. Order-no.	Länge mm Length mm
30-324015-0	150
30-324017-0	175
30-324020-0	200
30-324025-0	250

Schwerlastdübel

- aus Stahl
- galvanisch verzinkt

Metal anchor

- zinc plated

Bestell-Nr. Order-no.	Abmessung mm Size mm
30-330001-9	M 6 x 62 x 45
30-330002-9	M 6 x 77 x 45
30-330004-9	M 8 x 78 x 55
30-330005-9	M 8 x 88 x 55
30-330006-9	M 8 x 103 x 55
30-330007-9	M 10 x 84 x 65
30-330008-9	M 10 x 94 x 65
30-330009-9	M 10 x 104 x 65
30-330010-9	M 10 x 124 x 65
30-330011-9	M 10 x 144 x 65
30-330013-9	M 12 x 115 x 85
30-330014-9	M 12 x 125 x 85
30-330015-9	M 12 x 145 x 85
30-330017-9	M 16 x 145 x 105
30-330018-9	M 16 x 165 x 105

**Schwerlastdübel mit Ösenschraube**

- aus Stahl
- galvanisch verzinkt

Metal anchor

- with forged eyebolt
- zinc plated

Bestell-Nr. Order-no.	Abmessung mm Size mm
30-332006-9	M 6 x 40 x 45
30-332008-9	M 8 x 50 x 55
30-332010-9	M 10 x 60 x 65
30-332012-9	M 12 x 80 x 85

**Schwerlastdübel**

- aus Stahl
- mit Sechskantschraube
- galvanisch verzinkt

Metal anchor

- with hexagonal screw
- zinc plated

Bestell-Nr. Order-no.	Abmessung mm Size mm
30-331002-9	M 6 x 60 x 45
30-331003-9	M 6 x 80 x 45
30-331004-9	M 8 x 83 x 55
30-331005-9	M 8 x 93 x 55
30-331006-9	M 8 x 103 x 55
30-331007-9	M 10 x 86 x 65
30-331008-9	M 10 x 106 x 65
30-331009-9	M 10 x 126 x 65
30-331010-9	M 10 x 156 x 65
30-331011-9	M 12 x 115 x 85
30-331012-9	M 12 x 145 x 85
30-331013-9	M 12 x 165 x 85
30-331015-9	M 16 x 148 x 105

**Schwerlastdübel mit Hakenschraube**

- aus Stahl
- galvanisch verzinkt

Matal anchor

- with forget hookbolt
- zinc plated

Bestell-Nr. Order-no.	Abmessung mm Size mm
30-333006-9	M 6 x 40 x 45
30-333008-9	M 8 x 50 x 55
30-333010-9	M 10 x 60 x 65
30-333012-9	M 12 x 80 x 85



Setzeisen

- für Stahlnägel und Fixpins
- verzinkt

Nail setter

- for steel nails and fixpins
- galvanized



Bestell-Nr.
Order-no.

30-334904-0

30-334906-0

Abmessung mm
Size mm

M 4/135 x 14

M 6/135 x 14

Setzeisen

- für Stahlnägel und Fixpins
- mit Handschutz
- verzinkt

Nail setter

- for steel nails and fixpins
- galvanized
- with hand protector



Bestell-Nr.
Order-no.

30-335104-0

30-335106-0

Abmessung mm
Size mm

Ø 4,2/170 x 18

Ø 6,0/170 x 18

Setzeisen

- geschlitzt
- für Stahlnägel und Fixpins
- verzinkt

Nail setter

- slotted
- for steel nails and fixpins
- galvanized



Bestell-Nr.
Order-no.

30-335040-0

30-335060-0

Abmessung mm
Size mm

M 4/135 x 14

M 6/135 x 14

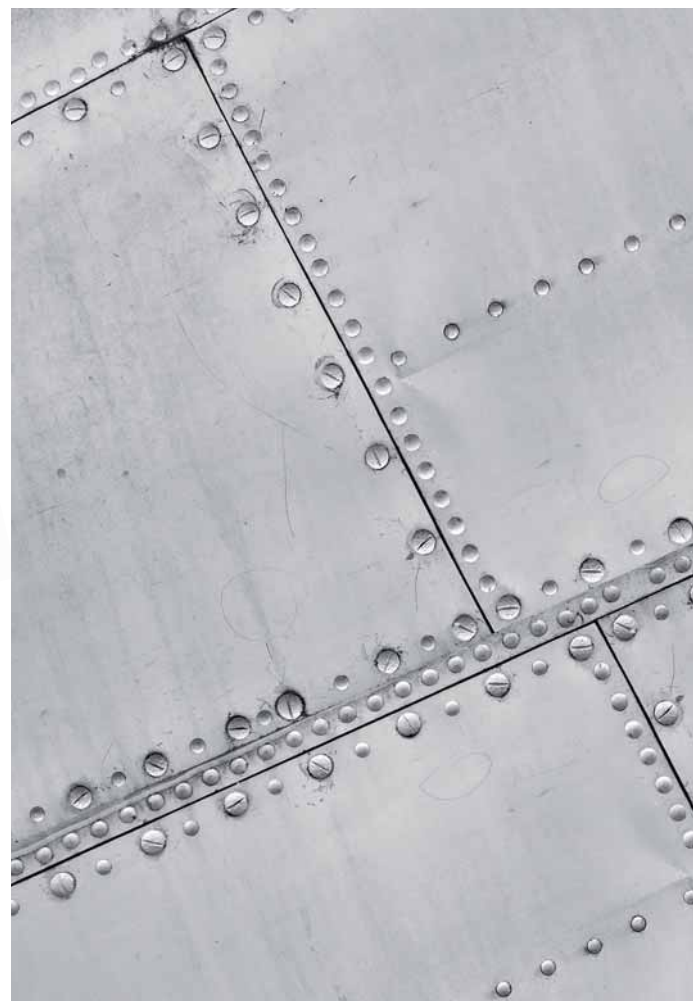

Ganzstahl-Schraubstock

- mit kleinem Amboss
- feststehend
- lackiert

All steel vice with anvil

- fixed
- varnished

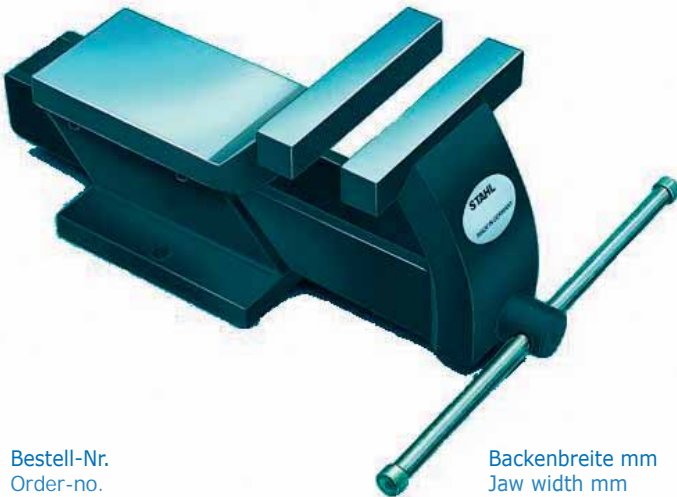

Bestell-Nr.
Order-no.

30-340010-0

30-340012-0

30-340015-0

Backenbreite mm
Jaw width mm

100

125

150

Heimwerker-Schraubzwinde

- Temperguss-Spannarmer
- verzinkte Schiene
- Holzheft rot lackiert

Screw clamp

- for DIY
- arms of cast iron
- bar galvanized
- with red wooden handle



Bestell-Nr. Länge Schiene x Arm mm Schiene Breite x Stärke mm
Order-no. Length rail x arm mm Rail width x strength mm

30-352001-0

150 x 80

22 x 6

30-352002-0

200 x 80

22 x 6

30-352003-0

250 x 80

22 x 6

30-352004-0

300 x 80

22 x 6

30-352005-0

400 x 80

22 x 6

30-352006-0

500 x 80

22 x 6

30-352007-0

200 x 100

25 x 6

30-352008-0

250 x 100

25 x 6

30-352009-0

300 x 100

25 x 6

30-352010-0

400 x 100

25 x 6

30-352011-0

500 x 100

25 x 6

30-352012-0

600 x 100

25 x 6

30-352013-0

750 x 100

25 x 6

30-352014-0

1.000 x 100

25 x 6

Aluminium-Auflegebacken

universal verwendbar

Aluminium lay on jaws

universal usable



Bestell-Nr.
Order-no.

30-341010-0

30-341012-0

30-341013-0

30-341015-0

30-341017-0

Backenbreite mm
Jaw width mm

100

125

135

150

175



Schraubzwinde DIN 5117

- Temperguss-Spannarme
- verzinkte Schiene
- Holzheft rot lackiert

Screw clamp DIN 5117

- arms of cast iron
- bar galvanized
- with red wooden handle



Bestell-Nr. Order-no.	Länge Schiene x Arm mm Length rail x arm mm	Schiene Breite x Stärke mm Rail width x strength mm
30-353001-0	150 x 80	25 x 6
30-353002-0	200 x 80	25 x 6
30-353003-0	250 x 80	25 x 6
30-353004-0	300 x 80	25 x 6
30-353005-0	400 x 80	25 x 6
30-353006-0	500 x 80	25 x 6
30-353007-0	200 x 100	30 x 8
30-353008-0	250 x 100	30 x 8
30-353009-0	300 x 100	30 x 8
30-353010-0	400 x 100	30 x 8
30-353011-0	500 x 100	30 x 8
30-353012-0	600 x 100	30 x 8
30-353013-0	800 x 100	30 x 8
30-353014-0	1.000 x 100	30 x 8
30-353015-0	250 x 120	30 x 8
30-353016-0	300 x 120	30 x 8
30-353017-0	400 x 120	30 x 8
30-353018-0	500 x 120	30 x 8
30-353019-0	600 x 120	30 x 8
30-353020-0	800 x 120	30 x 8
30-353021-0	1.000 x 120	30 x 8
30-353022-0	1.250 x 120	30 x 8
30-353023-0	1.500 x 120	30 x 8
30-353024-0	2.000 x 120	30 x 8
30-353025-0	300 x 140	35 x 9
30-353026-0	400 x 140	35 x 9
30-353027-0	500 x 140	35 x 9
30-353028-0	600 x 140	35 x 9
30-353029-0	800 x 140	35 x 9
30-353030-0	1.000 x 140	35 x 9
30-353031-0	1.250 x 140	35 x 9
30-353032-0	1.500 x 140	35 x 9
30-353033-0	2.000 x 140	35 x 9

Tiefspann- Schraubzwinde

- schwere Ausführung für das Bauhandwerk und Montagearbeiten
- Holzheft rot lackiert

Screw clamp

- with extra long arms
- Industrial quality
- with red wooden handle



Bestell-Nr. Order-no.	Länge Schiene x Arm mm Length rail x arm mm	Schiene Breite x Stärke mm Rail width x strength mm
30-354001-0	400 x 175	35 x 9
30-354002-0	500 x 175	35 x 9
30-354003-0	600 x 175	35 x 9
30-354004-0	800 x 175	35 x 9
30-354005-0	1.000 x 175	35 x 9
30-354006-0	400 x 200	35 x 11
30-354007-0	500 x 200	35 x 11
30-354008-0	600 x 200	35 x 11
30-354009-0	800 x 200	35 x 11
30-354010-0	1.000 x 200	35 x 11
30-354011-0	400 x 250	45 x 12
30-354012-0	500 x 250	45 x 12
30-354013-0	600 x 250	45 x 12
30-354014-0	800 x 250	45 x 12
30-354015-0	1.000 x 250	45 x 12
30-354016-0	400 x 300	45 x 12
30-354017-0	500 x 300	45 x 12
30-354018-0	600 x 300	45 x 12
30-354019-0	800 x 300	45 x 12
30-354020-0	1000 x 300	45 x 12
30-354021-0	400 x 400	45 x 12
30-354022-0	500 x 400	45 x 12
30-354023-0	600 x 400	45 x 12
30-354024-0	800 x 400	45 x 12
30-354025-0	1.000 x 400	45 x 12

Elektro-LötKolben 230 Volt

- mit Holzgriff
- 2-adrig
- mit Eurostecker

Electric soldering iron 230 Volt

- with wooden handle
- 2-core
- with Euro plug

Bestell-Nr. Order-no.	Watt Watts
30-368040-0	40
30-368060-0	60
30-368075-0	75
30-368100-0	100
30-368150-0	150
30-368200-0	200
30-368250-0	250
30-368300-0	300
30-368400-0	400
30-368500-0	500

**Elektro-LötKolben**

- mit vernickelter Lötspitze
- 230 Volt-50 Hz.
- geprüfte Qualität nach VDE 0700

Soldering iron

- with nickel soldering point
- 230 Volt-50 Hz.
- with approval accord. to VDE 0700



Bestell-Nr. Order-no.	Watt Watts
30-370002-9	15
30-370003-9	30
30-370006-9	60
30-370008-9	80
30-370010-9	100

Entlötpumpe

- mit Heizung
- 230 Volt

Desoldering pump

- with heater
- 230 Volt



Bestell-Nr. Order-no.	Watt Watts
30-371000-9	30

Elektro-LötKolben 230 Volt CE

- mit Holzgriff
- 3-adrig
- mit Eurostecker

Electric soldering iron 230 Volt CE

- with wooden handle
- 3-core
- with Euro plug

Bestell-Nr. Order-no.	Watt Watts
30-372504-0	40
30-372506-0	60
30-372507-0	75
30-372510-0	100
30-373015-0	150
30-373020-0	200
30-376025-0	250
30-376030-0	300
30-376040-0	400
30-376050-0	500



CE

Ersatz-Heizkörper

für Elektro-LötKolben 230 Volt

Spare resistance

for electrical soldering iron 230 Volt

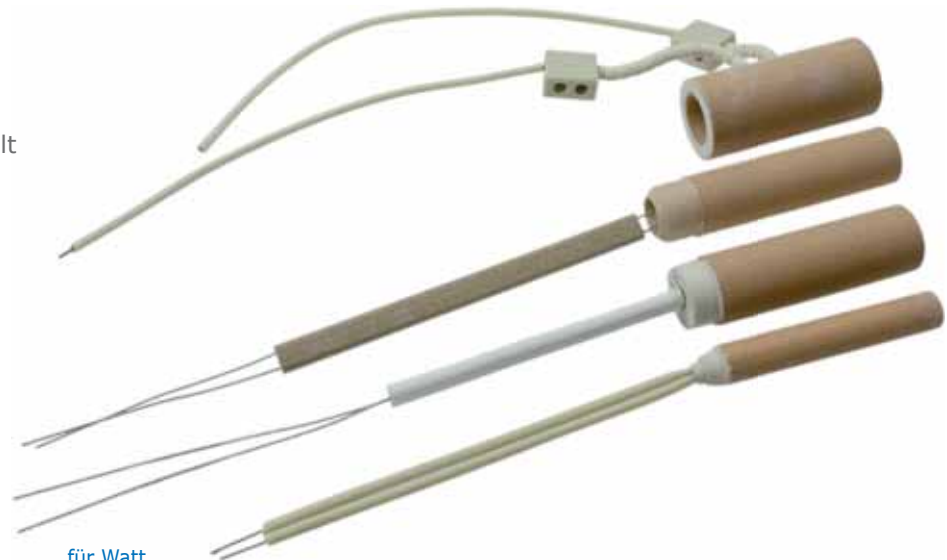

Bestell-Nr. Order-no.	für Watt for Watts
30-378504-0	40
30-378506-0	60
30-378507-0	75
30-378510-0	100
30-378515-0	150
30-378520-0	200
30-378525-0	250
30-378530-0	300
30-378540-0	400
30-378550-0	500

Lötpestole

- mit eingebauter Lötstellenbeleuchtung
- 230 Volt

Soldering gun

- with soldering position light
- 230 Volt



Bestell-Nr.
Order-no.

30-380000-9

Watt
Watts

100

**STANNOL Lötset SK 3000**

- mit Lötpestole 100 W
- 230 Volt
- 7-teilig
im Kasten mit
1 Ersatzspitze
1 LötKolben 30 W mit Aufsteller
1 Entlötpumpe
1 Bauteilentferner
1 Stück 3-Hand
1 Radiolötstift 20 g

STANNOL soldering set SK 3000

- with soldering pistole 100 W
- 230 Volt
- set of 7 pieces
in case with
1 spare point
soldering iron 30 W
soldering pump etc.



Bestell-Nr.
Order-no.

30-381000-9

Elektro-LötKolben 120 Volt

- mit Holzgriff
- 2-adrig
- mit amerikanischem Flachstiftstecker

Electric soldering iron 120 Volt

- with wooden handle
- 2-core
- with american flat-pin plug

Bestell-Nr. Order-no.	Watt Watts
30-382040-0	40
30-382060-0	60
30-382075-0	75
30-382100-0	100
30-382150-0	150
30-382200-0	200
30-382250-0	250
30-382300-0	300
30-382400-0	400
30-382500-0	500

**Ersatz-Heizkörper**

für Elektro-LötKolben 120 Volt

Spare resistance

for electrical soldering iron 120 Volt

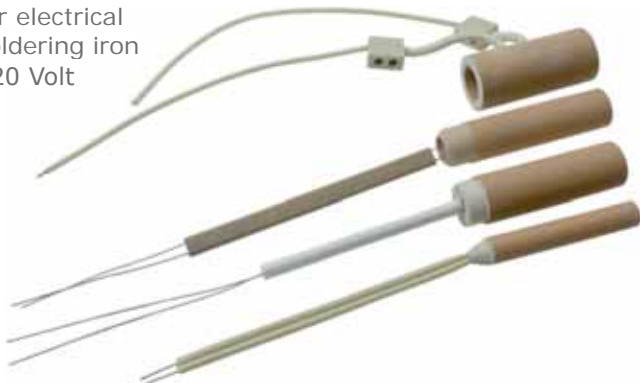

Bestell-Nr. Order-no.	für Watt for Watts
30-382604-0	40
30-382606-0	60
30-382607-0	75
30-382610-0	100
30-382615-0	150
30-382620-0	200
30-382625-0	250
30-382630-0	300
30-382640-0	400
30-382650-0	500

Ersatz-Lötspitze

für Elektro-LötKolben 120 und 230 Volt

Spare points

for electrical soldering iron 120 and 230 Volt



Bestell-Nr. Order-no.	für Watt for Watts
30-382701-0	40/60
30-382702-0	75/100
30-382703-0	150/200
30-382725-0	250
30-382730-0	300
30-382740-0	400
30-382750-0	500

Klebepistole

- mit 2 Klebestangen
- 230 Volt
- Blister verpackt

Glue gun

- with 2 pieces glue sticks
- 230 Volt
- on blister



Bestell-Nr. Order-no.	Stangen Ø mm Sticks Ø mm	Watt Watts
30-383000-9	11	72 (12)

Lötendraht S-Pb60Sn40

- auf Karte
- 1 m

Soldering wire S-Pb60Sn40

- on card of
- 1 m



Bestell-Nr. Order-no.	Draht Ø mm Wire Ø mm
30-390000-0	1,5

Klebestange

- transparent
- 500 g
- ca. 25 Stück

Glue stick

- transparent
- 500 g
- approx. 25 pieces



Bestell-Nr. Order-no.	Stangen Länge x Ø mm Sticks lenght x Ø mm
30-384020-0	200 x 11

Lötendraht S-Pb70Sn30

- auf Rolle
- Flux EN 29454 1.1.2/2,5 %

Soldering wire S-Pb70Sn30

- on roll
- Flux EN 29454 1.1.2/2,5 %



Bestell-Nr. Order-no.	Draht Ø mm Wire Ø mm	Gewicht Rolle g Weight roll g
30-391010-0	1,0	100
30-391025-0	1,0	250
30-392010-0	1,5	100
30-392025-0	1,5	250
30-393010-0	2,0	100
30-393025-0	2,0	250
30-394025-0	2,5	250
30-395025-0	3,0	250

Lötdraht S-Pb60Sn40

- auf Rolle
- Flux EN 29454 1.1.2/2,5 %

Soldering wire S-Pb60Sn40

- on roll
- Flux EN 29454 1.1.2/2,5 %



Bestell-Nr. Order-no.	Draht Ø mm Wire Ø mm	Gewicht Rolle g Weight roll g
30-400010-0	1,0	100
30-400025-0	1,0	250
30-401010-0	1,5	100
30-401025-0	1,5	250
30-402010-0	2,0	100
30-402025-0	2,0	250
30-403025-0	3,0	250

**Fittingslotdraht S-Pb50Sn50
DIN EN 29453**

- massiv
- auf Rolle

**Fitting solid solder wire
DIN EN 29453**

- S-Pb50Sn 50
- on roll



Bestell-Nr. Order-no.	Draht Ø mm Wire Ø mm	Gewicht Rolle g Weight roll g
30-407025-0	3,0	250

Lötdraht S-Pb40Sn60

- auf Rolle
- F-SW 26 1.1.2.ROM1/2,5%

Soldering wire S-Pb40Sn60

- on roll
- F-SW 26 1.1.2.ROM1/2,5%



Bestell-Nr. Order-no.	Draht Ø mm Wire Ø mm	Gewicht Rolle g Weight roll g
30-404010-0	1,0	100
30-405010-0	1,5	100
30-406010-0	2,0	100
30-406225-0	3,0	250

Lötstange dreikant

- ca. 440 mm lang
- in Kartons zu 25 kg

Solder rod, triangle

- approx. 440 mm long
- in cartons of 25 kgs

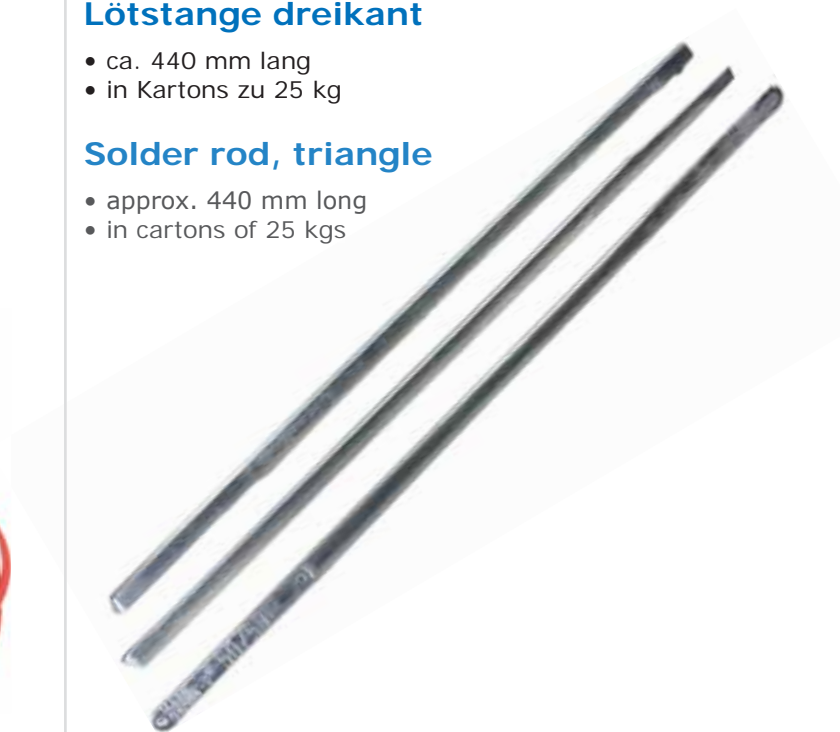

Bestell-Nr. Order-no.	Zusammensetzung Composition
30-407230-0	Pb70Sn30 (SNL30)
30-407250-0	Pb50Sn50 (SNL50)

Kupfer-LötKolben Hammerform

- mit Holzgriff

Soldering copper hammer type

- with wooden handle



Bestell-Nr. Order-no.	Gewicht g weight g
30-410010-0	100
30-410015-0	150
30-410020-0	200
30-410025-0	250
30-410030-0	300
30-410035-0	350
30-410040-0	400
30-410050-0	500

Kupfer-LötKolben Spitzform

- mit Holzgriff

Soldering copper pointed head

- with wooden handle



Bestell-Nr. Order-no.	Gewicht g weight g
30-411010-0	100
30-411015-0	150
30-411020-0	200
30-411025-0	250
30-411030-0	300
30-411035-0	350
30-411040-0	400
30-411050-0	500

Lötfett in Dosen

- nach DIN EN 29454.1
- 3.1.1.C
- zum Weichlöten und Verzinnen

Soldering grease in box

- accord. to DIN EN 29454.1
- 3.1.1.C
- for soldering and tinning



Bestell-Nr. Order-no.	Gewicht g weight g
30-415005-0	50
30-415010-0	100
30-415025-0	250

Weichlötmasse

- zum Löten und Verzinnen
- L-PbSn 40 (SB) nach DIN 8511 F-SW 21

Soldering paste

- for soldering and tinning
- L-PbSn 40 (SB) accord. to DIN 8511 F-SW 21



Bestell-Nr. Order-no.	Gewicht g weight g
30-416010-0	100
30-416025-0	250

Hartlötpulver R4

- zum Löten für Kupfer
Kupfernickel-Legierungen
Messing
Neusilber
Stahl
Gusseisen
Rotguss und verzinkten Stahlblechen
- Arbeitstemperatur 700-1.100°C
- mit Wasser zur Paste anrührbar

Brazing powder R4

- for copper
copper alloys
steel
chrome-nickel steel
cast iron
malleable iron and cast steel
- working temperature 700-1.100° C
- with water usable as paste



Bestell-Nr.
Order-no.

30-417025-0

30-417050-0

Gewicht g
weight g

250

500

Salmiak-Lötstein

weiß

Sal ammoniac stone

white



Bestell-Nr.
Order-no.

30-418006-0

30-418020-0

Länge x Breite x Höhe mm
Length x width x height mm

65 x 45 x 20

200 x 45 x 40



Bügelgasanzünder

mit Flachfeile

Gas lighter

with flat file

Bestell-Nr.
Order-no.**30-420000-0**Zündstein mm
Flints mm

3 x 20

Zündstein

- für Bügelgasanzünder
- Beutel zu 50 Stück

Flints

- for gas lighter
- bag of 50 pieces

Bestell-Nr.
Order-no.**30-422000-0**Zündstein mm
Flints mm

3 x 20

Bügelgasanzünder

mit Walzenfeile

Gas lighter

with rolling file

Bestell-Nr.
Order-no.**30-421000-0**Zündstein mm
Flints mm

3 x 20

Pistolen-Gasanzünder

rot lackiert

Gas lighter

red varnished

Bestell-Nr.
Order-no.**30-424000-9**

Elektrodenhalter TOP

- mit schwarzem Handrohr
- extra schwer

Electrode holder TOP

- heavy pattern
- with black handle



Bestell-Nr. Order-no.	Ampere Ampere
30-430020-0	200
30-430030-0	300
30-430040-0	400
30-430060-0	600

Elektrodenhalter STANDARD

mit schwarzem Handrohr

Electrode holder STANDARD"

with black handle



Bestell-Nr. Order-no.	Ampere Ampere
30-431040-0	400
30-431050-0	500
30-431060-0	600



Ladezange

- vernickelt
- teilisoliert
- für Lötanschluss

Battery charging clamp

- nickel plated
- partial insulated
- for soldering connection



Bestell-Nr. Order-no.	Farbe Colour	Ampere Ampere
30-432080-0	rot/red	80
30-432081-0	schwarz/black	80
30-432100-0	rot/red	100
30-432101-0	schwarz/black	100
30-432200-0	rot/red	200
30-432201-0	schwarz/black	200

Kabelkupplung Stecker

- mit Gummiisolierung

Welding connector

- with rubber handle
- male



Bestell-Nr. Order-no.	für Kabel Querschnitt mm ² for cable cross section mm ²
30-435010-0	10-25
30-435035-0	35-50

Schweißkabel

kunststoffisoliert

Welding cable

PVC covered



Bestell-Nr. Order-no.	Kabel Querschnitt mm ² cable cross section mm ²	Rollenlänge m Length of roll m
30-433016-0	16	50
30-433025-0	25	50
30-433035-0	35	50
30-433050-0	50	50

Kabelkupplung Buchse

- mit Gummiisolierung

Welding bush

- with rubber handle
- female



Bestell-Nr. Order-no.	für Kabel Querschnitt mm ² for cable cross section mm ²
30-436010-0	10-25
30-436035-0	35-50

Erdklemme/Polklemme

mit Messing oder Kupferband

Earth clamp

with brass or copper strip



Bestell-Nr. Order-no.	für Belastungen bis Ampere for use up to Ampere
30-437020-9	200
30-437020-0	200
30-437025-0	250
30-437030-9	300
30-437030-0	300
30-437040-0	400
30-437060-0	600

Sauerstoff-Druckminderer

- einstufige Bauart
- Anschluss nach Wunsch

Oxygen regulator

- single stage
- connection accord. to demand



Bestell-Nr. Order-no.	Arbeitsmanometer working manometer	Inhaltsmanometer Volume manometer
30-438000-0	0-16/10 bar	0-315/200 bar

**Acetylen-Druckminderer**

- einstufige Bauart
- Anschluss nach Wunsch

Acetylene regulator

- single stage
- connection accord. to demand

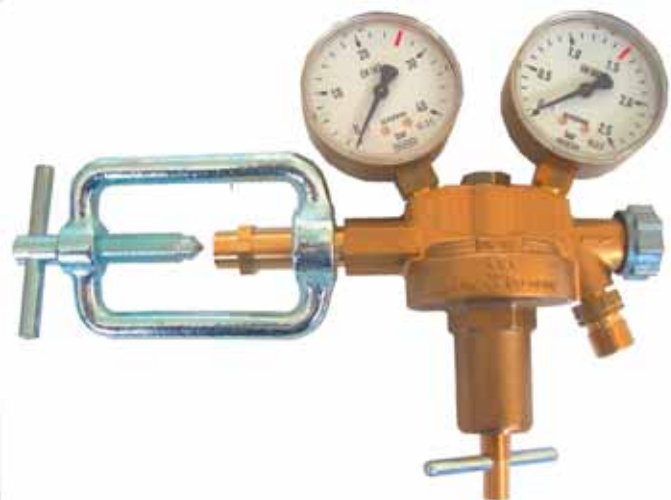

Bestell-Nr. Order-no.	Arbeitsmanometer working manometer	Inhaltsmanometer Volume manometer
30-439000-0	0-2,5/1,5 bar	0-40 bar

Niederdruck-Regler JUMBO

- SRG altes Modell Type 591
- mit Ein-/Aus-Schalter
- für Schlauchanschluss Ø 8 mm

Low pressure regulator JUMBO

- SRG old model type 591
- with on/off switch
- for hose connection Ø 8 mm



Bestell-Nr. Order-no.	Typ Type	Detail Detail
30-440000-0	591	ohne Abschaltautomatik/without flow
30-440001-0	591	mit Abschaltautomatik/with flow

Hochdruck-Regler JUMBO

- SRG Type 552-0 altes Modell
- mit Ein-/Aus-Schalter
- Schlauchanschluss Ø 8 mm

High pressure regulator JUMBO

- SRG Type 552-0 old model
- with on/off switch
- hose connection Ø 8 mm



Bestell-Nr. Order-no.	Typ Type	Detail Detail
30-441000-0	552-0	ohne Abschaltautomatik/without flow

Niederdruck-Regler JUMBO

- SRG neues Modell Typ 592
- mit Ein-/Aus-Schalter
- für Schlauchanschluss Ø 8 mm

Low pressure regulator JUMBO

- SRG new model type 592
- with on/off switch
- for hose connection Ø 8 mm



Bestell-Nr. Order-no.	Typ Type	Detail Detail
30-440006-0	592	ohne Abschaltautomatik/without flow
30-440007-0	592	mit Abschaltautomatik/with flow

Hochdruck-Regler JUMBO

- SRG neues Modell Typ 552-1 neues Modell
- mit Ein-/Aus-Schalter
- für Schlauchanschluss Ø 8 mm

High pressure regulator JUMBO

- SRG new model type 552-1 new model
- with on/off switch
- for hose connection Ø 8 mm



Bestell-Nr. Order-no.	Typ Type	Detail Detail
30-441006-0	552-1	ohne Abschaltautomatik/without flow

Handschuttschild

- Type „C“ für Schweißarbeiten
- aus glasfaserverstärktem Kunststoff
- CE-geprüft
- ohne Glas

Hand welding shield

- made of glass-fiber reinforced plastic
- CE-tested
- without glass

Bestell-Nr.
Order-no.
30-444000-9

Glas Höhe x Breite mm
Glass height x width mm
90 x 110 mm



CE

Kopf-Schutzschirm

- Type „E“ für Schweißarbeiten
- Kopfband verstellbar
- CE-geprüft
- ohne Glas

Welder's head shield

- made of glass-fiber reinforced plastic
- headband adjustable
- CE-tested
- without glass

Bestell-Nr.
Order-no.
30-445000-9

Glas Höhe x Breite mm
Glass height x width mm
90 x 110 mm



CE

Freisicht-Handschuttschild

- Type „D“ für Schweißarbeiten
- aus glasfaserverstärktem Kunststoff
- CE-geprüft
- ohne Glas

Hand welding shield Clear View

- made of glass-fiber reinforced plastic
- CE-tested
- without glass

Bestell-Nr.
Order-no.
30-446000-9

Glas Höhe x Breite mm
Glass height x width mm
90 x 110 mm



CE

Automatik-Schutzhelm

- geeignet für
Elektrodenschweißen
MIG/MAG/TIG
Hochleistungsschweißen
Fülldrahtschweißen
Plasmaschweißen
WIG 5 A
- Sichtfeld 42 x 100 mm

Autodarkening welding helmet

- delay and sensitivity preselected by means of a switch inside the helmet
- useable for
welding electrodes
MIG/MAG/TIG
high recovery welding
fluxcored wires
plasmawelding
WIG 5 A
- viewing area 42 x 100 mm

Bestell-Nr.

Order-no.

30-447500-9



Automatik-Schutzhelm

- geeignet nur für
Elektrodenschweißen
MIG/MAG
WIG 40 A
- Sichtfeld 46 x 98 mm

Autodarkening welding helmet

- only useable for
stick electrodes
MIG/MAG
WIG 40 A
- viewing area 46 x 98 mm
- delay and sensitivity

Bestell-Nr.

Order-no.

30-447600-9



Panorama Schutzbrille Modell 620

- Bügel verstellbar in Länge und Neigung
- blau/grau
- Innenseite soft

Panorama safety glasses model 620

- frame adjustable in length and inclination of sidearm
- inside soft
- blue/grey



Bestell-Nr.
Order-no.

30-450000-0

Nylon-Schutzbrille Modell 870

- mit Seitenschutz
- Fassung schwarz
- Glas farblos PC 1 mm

Nylon protection glasses model 870

- with side protectors
- frame black
- glass clear PC 1 mm



Bestell-Nr.
Order-no.

30-451001-0

Glas
Glass

62 x 52

Nylon-Schutzbrille Modell 870

- mit Seitenschutz
- Fassung beige
- Glas farblos PC 1 mm

Nylon protection glasses model 870

- with side protectors
- frame beige
- glass clear PC 1 mm



Bestell-Nr.
Order-no.

30-451000-0

Glas
Glass

62 x 52

Nylon-Schutzbrille Modell 872

- mit Seitenschutz
- Fassung schwarz
- Glas grün ohne DIN

Nylon protection glasses model 872

- with side protectors
- frame black
- green glass without DIN



Bestell-Nr.
Order-no.

30-451500-0

Glas
Glass

62 x 52

Vollsichtbrille Modell 443

- mit direkter Ventilation
- farblos PC 1
- mit Gummiband

Full view goggle model 443

- with ventilation around the outer frame
- all clear
- with adjustable headband



Bestell-Nr.
Order-no.

30-454000-0

Nylon-Schutzbrille Modell 879

- mit Seitenschutz
- leichter Glaswechsel
- Bügel beige
- Glas farblos 2 mm ungenormt

Nylon protection glasses model 879

- with side protectors
- frame beige
- glass clear 2 mm non-standard



Bestell-Nr.
Order-no.

30-455001-0

Glas
Glass

Clear/Ø 50 mm

Nylon-Schutzbrille Modell 879

- mit Seitenschutz
- leichter Glaswechsel
- Bügel beige

Nylon protection glasses model 879

- with side protectors
- easy change of glass
- frame beige



Bestell-Nr.
Order-no.

30-455000-0

Glas
Glass

DIN 6/Ø 50 mm

Nylon-Schutzbrille Modell 879

- mit Seitenschutz
- leichter Glaswechsel
- Bügel schwarz

Nylon protection glasses model 879

- with side protectors
- easy change of glass
- frame black



Bestell-Nr.
Order-no.

30-455100-0

Glas
Glass

DIN 6/Ø 50 mm

Schweißerbrille Modell 722

- mit hochklappbaren Schweißerschutzgläsern außen DIN 5
- innen farblos PC
- mit indirekter Ventilation
- verstellbares Kopfband

Welding goggle model 722

- with flip up mechanism
- glass outside DIN 5
- inside clear
- with indirect ventilation and adjustable headband



Bestell-Nr.
Order-no.

30-459000-0

Glas
Glass

Ø 50 mm

Nylon-Schutzbrille

- mit Seitenschutz
- Sichtglas hell gelb
- Bügel verstellbar

Nylon protection glasses

- with side protectors
- yellow lenses
- adjustable frame



Bestell-Nr.
Order-no.

30-459200-9

Nylon-Schutzbrille

- für Autogenschweißen
- mit Seitenschutz
- Glas grün
- Bügel verstellbar

Nylon protection glasses

- for autogenous/as welding
- with side protectors
- glass green
- frame adjustable



Bestell-Nr.
Order-no.

30-459100-9

Glas
Glass

DIN 5

Nylon-Schutzbrille

- mit Seitenschutz
- Sichtglas transparent
- Bügel verstellbar

Nylon protection glasses

- with side protectors
- clear lenses
- adjustable frame



Bestell-Nr.
Order-no.

30-459300-9

Schweißer-Schutzglas

- nach DIN gefertigt
- einzeln verpackt
- 100 Stück im Karton

Welding glass

- according to DIN
- single packed
- box of 100 pieces



Bestell-Nr. Order-no.	Höhe x Breite mm Height x width mm	Schutzstufe scale number
30-460009-0	51 x 108	DIN 9
30-460010-0	51 x 108	DIN 10
30-460011-0	51 x 108	DIN 11
30-460012-0	51 x 108	DIN 12
30-460013-0	51 x 108	DIN 13
30-460508-0	50 x 105	DIN 8
30-460509-0	50 x 105	DIN 9
30-460510-0	50 x 105	DIN 10
30-460511-0	50 x 105	DIN 11
30-460512-0	50 x 105	DIN 12
30-461009-0	90 x 110	DIN 9
30-461010-0	90 x 110	DIN 10
30-461011-0	90 x 110	DIN 11
30-461012-0	90 x 110	DIN 12
30-461013-0	90 x 110	DIN 13
30-462009-0	100 x 100	DIN 9
30-462010-0	100 x 100	DIN 10
30-462011-0	100 x 100	DIN 11

Schutzglas

- glasklar
- 150 Stück im Karton

Protecting glass

- colourless
- box of 150 pieces

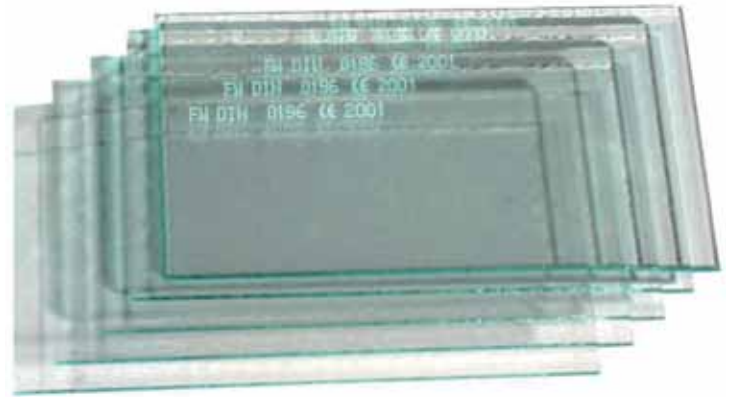

Bestell-Nr. Order-no.	Höhe x Breite mm Height x width mm
30-463050-0	50 x 105
30-463051-0	51 x 108
30-463055-0	55 x 110
30-463090-0	90 x 110
30-463010-0	100 x 100



Hand-Drahtbürste

- mit poliertem geradem Draht
- mit Holzkörper
- 12 Stück verpackt

Hand wire brush

- with polished wire
- straight
- with wooden back
- 12 pieces in box



Bestell-Nr. Order-no.	Drahtreihen Wire rows
30-470003-0	3
30-470004-0	4
30-470005-0	5
30-470006-0	6

**Hand-Drahtbürste**

- mit vermessingtem gewelltem Draht
- mit Holzrücken
- 12 Stück verpackt

Hand wire brush

- with brassed wire, curled
- with wooden back
- 12 pieces in box

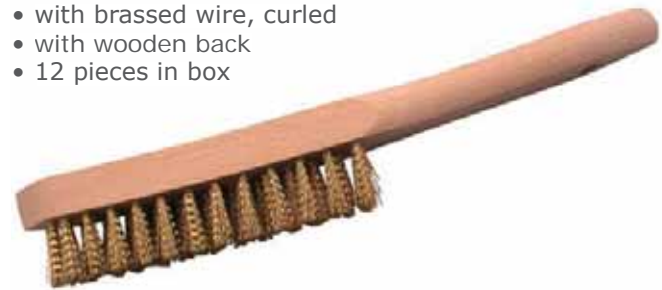

Bestell-Nr. Order-no.	Drahtreihen Wire rows
30-472503-0	3
30-472504-0	4
30-472505-0	5
30-472506-0	6

Hand-Drahtbürste

- mit vermessingtem geradem Draht
- mit Holzkörper
- 12 Stück verpackt

Hand wire brush

- with brassed wire
- straight
- with wooden back
- 12 pieces in box



Bestell-Nr. Order-no.	Drahtreihen Wire rows
30-472003-0	3
30-472004-0	4
30-472005-0	5
30-472006-0	6

Brenner-Reinigungsbürstenset

- Messing-Nylon-Stahldraht
- mit Kunststoffgriff

Hand wire brush set

- with brassed, nylon and steel wire
- with PVC handle



Bestell-Nr. Order-no.	Länge mm Length mm	Satz teilig set of pieces
30-474000-9	225	3

Rundbürste

- vermessingter Draht Ø 0,30 mm
- gewellt

Round wire brush

- brassed wire Ø 0,30 mm
- curled



Bestell-Nr. Order-no.	Ø mm Ø mm	Arbeitsbreite/Drahtlänge mm working width/wire length mm
30-476000-9	100	20 x 22
30-476001-9	125	18 x 27
30-476002-9	125	25 x 30
30-476003-9	150	18 x 28
30-476004-9	150	25 x 28
30-476005-9	178	20 x 37
30-476007-9	200	20 x 42
30-476008-9	200	25 x 42

Topfbürste

gewellter Stahldraht

Pot brush

curled wire

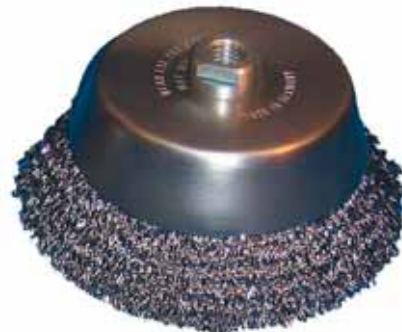

Bestell-Nr. Order-no.	Ø mm Ø mm	Gewinde Thread
30-477006-0	65	M 14
30-477008-0	80	M 14
30-477010-0	100	M 14
30-477012-0	125	M 14

Stahldraht-Rundbürste

mit gewelltem Draht Ø 0,30 mm

Round wire brush

with steel curled wire
Ø 0,30 mm



Bestell-Nr. Order-no.	Ø mm Ø mm	Arbeitsbreite/Drahtlänge mm working width/wire length mm
30-476001-0	125	22 x 30
30-476002-0	125	30 x 30
30-476003-0	150	21 x 25
30-476004-0	150	30 x 29
30-476005-0	178	23 x 38
30-476006-0	178	32 x 38
30-476007-0	200	20 x 38
30-476008-0	200	30 x 38
30-476009-0	250	28 x 47
30-476010-0	250	38 x 47
30-476011-0	300	44 x 50

Topfbürste

- gewellter vermessingter Draht
- rot lackiert

Pot brush

- curled brassed wire
- red varnished



Bestell-Nr. Order-no.	Ø mm Ø mm	Gewinde Thread
30-480007-9	75	M 14
30-480010-9	100	M 14

Scheiben-Bastlerbürste

gewellter Draht

Round wire brush

curled wire



Bestell-Nr. Order-no.	Ø mm Ø mm	Schaft Ø mm shank Ø mm
30-484007-9	75	6
30-484010-9	100	6

Topf-Bastlerbürste

gewellter Draht

Pot brush

curled wire



Bestell-Nr. Order-no.	Ø mm Ø mm	Schaft-Ø mm shank Ø mm
30-486050-9	50	6
30-486075-9	75	6

Pinsel-Bastlerbürste

gewellter Draht

End brush

curled wire



Bestell-Nr. Order-no.	Ø mm Ø mm	Schaft Ø mm shank Ø mm
30-485000-9	25	6



Kontrollspiegel

- für Schweißarbeiten
- biegsames Gelenk
- mit Magnet

Welding mirror

- flexible joint
- with magnet



Bestell-Nr.
Order-no.

30-490000-9

30-491000-0

Spiegelstärke mm
Mirror thickness mm

1,0

1,0-Ersatzspiegel/spare mirror

Schweißer-Gripzange

- mit vier Backen
- glanzvernickelt
- Chrom-Vanadium

Welding grip pliers

- with four jaws
- nickel plated
- Chrom-Vanadium



Bestell-Nr.
Order-no.

30-500000-0

Länge mm
Length mm

280

Spannweite mm
capacity mm

60

Schlackenhammer

- aus Metall
- für Schweißarbeiten
- lackiert

Welding hammer

- all metal
- for welding work
- varnished



Bestell-Nr.
Order-no.

30-495000-9

Rohr-Schweißer-Gripzange

- mit 4 Backen
- glanzvernickelt
- Chrom-Vanadium

Grip for tubes

- with 4 jaws
- nickel plated
- Chrom-Vanadium



Bestell-Nr.
Order-no.

30-501000-0

Länge mm
Length mm

280

Spannweite mm
capacity mm

10-90

Klammer-Gripzange

- glanzvernickelt
- Chrom-Vanadium

C-clamp grip pliers

- nickel plated
- Chrom-Vanadium



Bestell-Nr. Order-no.	Länge mm Length mm	Spannweite mm capacity mm
30-502028-0	280	90
30-502046-0	460	220
30-502060-0	600	320

Universal-Gripzange

- mit Drahtschneider
- Maul mit halbrunden Backen
- glanzvernickelt
- Chrom-Vanadium

Universal grip pliers

- with wire cutter
- halfround jaws
- nickel plated
- Chrom-Vanadium



Bestell-Nr. Order-no.	Länge mm Length mm	Spannweite mm capacity mm
30-504018-0	180	35
30-504025-0	250	50
30-504030-0	300	65

Parallel-Klammer-Gripzange

- mit beweglichen Backen
- glanzvernickelt
- Chrom-Vanadium

Parallel c-clamp grip pliers

- with moveable jaws
- nickel plated
- Chrom-Vanadium



Bestell-Nr. Order-no.	Länge mm Length mm	Spannweite mm capacity mm
30-503028-0	280	90
30-503046-0	460	225
30-503060-0	600	295

Universal-Gripzange

- mit geraden Backen
- glanzvernickelt
- Chrom-Vanadium

Universal grip pliers

- with straight jaws
- nickel plated
- Chrom-Vanadium



Bestell-Nr. Order-no.	Länge mm Length mm	Spannweite mm capacity mm
30-505000-0	250	40

Gripzange IDEAL

- mit Profil-Backen
- glanzvernickelt
- Chrom-Vanadium

Grip pliers IDEAL

- useable for flat, round shaped and square materials
- nickel plated
- Chrom-Vanadium



Bestell-Nr. Order-no.	Länge mm Length mm	Spannweite mm capacity mm
30-506018-0	180	35
30-506025-0	250	50

Gripzange PRISMA

- mit Längsrille
- glanzvernickelt
- Chrom-Vanadium

Grip pliers PRISMA

- longitudinal groove in the top jaw
- nickel plated
- Chrom-Vanadium



Bestell-Nr. Order-no.	Länge mm Length mm	Spannweite mm capacity mm
30-508018-0	180	30
30-508025-0	250	35

Gripzange Parallel PLUS

- mit einer beweglichen Backe
- gezahnt
- glanzvernickelt
- Chrom-Vanadium

Grip pliers Parallel PLUS

- combined jaw shape with one swivel jaw
- finely toothed
- nickel plated
- Chrom-Vanadium



Bestell-Nr. Order-no.	Länge mm Length mm	Spannweite mm capacity mm
30-507025-0	250	45

Breitmaul-Gripzange

besonders geeignet zum Biegen von dünnen und weichen Blechen

- glanzvernickelt
- Chrom-Vanadium

Grip pliers for sheet metal

clamping bending & crimping of thin and soft sheet metals

- nickel plated
- Chrom-Vanadium



Bestell-Nr. Order-no.	Länge mm Length mm	Spannweite mm capacity mm	Backenbreite mm jaw width mm
30-509000-0	180	45	80

Lamellenschleifteller

- mit Glasgewebeträger
- Normalkorund X-Gewebe
- hohe Abtragsleistung bei universellem Einsatz
- zur Bearbeitung von Stahl
- NE-Metallen und Aluminium

Abrasive flap discs

- with fibreglass backing
- durable X-weight cotton backing Aluminium Oxide
- very good stock removal capacity
- specially for surface work



Bestell-Nr. Order-no.	Ø mm Ø mm	Loch Ø mm Hole Ø mm	Körnung Grit
30-510001-0	115	22,2	40
30-510002-0	115	22,2	60
30-510003-0	115	22,2	80
30-510004-0	115	22,2	120
30-510005-0	125	22,2	40
30-510006-0	125	22,2	60
30-510007-0	125	22,2	80
30-510008-0	125	22,2	120
30-510009-0	178	22,2	40
30-510010-0	178	22,2	60
30-510011-0	178	22,2	80

Lamellenschleifteller PRO

- mit Glasgewebeträger
- Zirkonkorund X-Gewebe aus Baumwollpolyester-Mischgewebe
- sehr gute Abtragsleistung bei exzellenter Standzeit
- ideal für Flächenanschliff
- zur Bearbeitung von Stahlblechen und Edelstahl

Abrasive flap discs PRO

- with fibreglass backing
- high performance X-weight polyester cotton backing Aluminium Zirconia
- long-lasting and economical all purpose flap disc
- ideal for deburring blending welds
- specially for steel panel and stainless steel



Bestell-Nr. Order-no.	Ø mm Ø mm	Loch Ø mm Hole Ø mm	Körnung Grit
30-510101-0	115	22,2	40
30-510102-0	115	22,2	60
30-510103-0	115	22,2	80
30-510104-0	115	22,2	120
30-510105-0	125	22,2	40
30-510106-0	125	22,2	60
30-510107-0	125	22,2	80
30-510108-0	125	22,2	120
30-510109-0	178	22,2	40
30-510110-0	178	22,2	60
30-510111-0	178	22,2	80

Fächerschleifer

zum Bearbeiten, Strukturieren, Entgraten und Reinigen von Gußteilen.

Zum Formen von Werkzeugen, Metallen, Holz und Kunststoffen. Radial angeordnete Lamellen aus flexiblem Schleifgewebe erlauben eine optimale Anpassung an das zu bearbeitende Werkstück

- Schaft 6 mm

Abrasive flap wheels

for grinding, blending, deburring and cleaning of castings. For moulding tools, metal, wood and plastic

- shank 6 mm



Bestell-Nr. Order-no.	Ø mm Ø mm	Breite mm Width mm	Körnung Grit
30-511001-0	50	20	40
30-511002-0	50	20	60
30-511003-0	50	20	80
30-511004-0	50	20	120
30-511005-0	50	20	150
30-511006-0	50	20	180
30-511007-0	50	20	240
30-511008-0	50	20	320
30-511009-0	50	30	40
30-511010-0	50	30	60
30-511011-0	50	30	80
30-511012-0	50	30	120
30-511013-0	50	30	150
30-511014-0	50	30	180
30-511015-0	50	30	240
30-511016-0	50	30	320
30-511017-0	60	30	40
30-511018-0	60	30	60
30-511019-0	60	30	80
30-511020-0	60	30	120
30-511021-0	60	30	150
30-511022-0	60	30	180

Bestell-Nr. Order-no.	Ø mm Ø mm	Breite mm Width mm	Körnung Grit
30-511023-0	60	30	240
30-511024-0	60	30	320
30-511025-0	60	50	40
30-511026-0	60	50	60
30-511027-0	60	50	80
30-511028-0	60	50	120
30-511029-0	60	50	150
30-511030-0	60	50	180
30-511031-0	60	50	240
30-511032-0	60	50	320
30-511033-0	80	30	40
30-511034-0	80	30	60
30-511035-0	80	30	80
30-511036-0	80	30	120
30-511037-0	80	30	150
30-511038-0	80	30	180
30-511039-0	80	30	240
30-511040-0	80	30	320



Fiberscheibe für Metall

mit Schlitzloch

Fibre disc for metal

with slotted hole

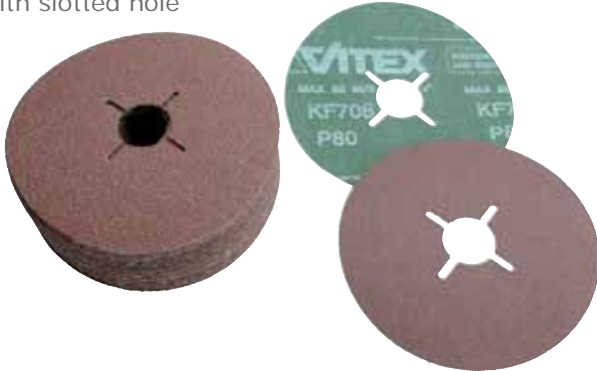

Bestell-Nr. Order-no.	Körnung Grit	Ø mm Ø mm
30-512024-0	24	115/22
30-512036-0	36	115/22
30-512040-0	40	115/22
30-512050-0	50	115/22
30-512060-0	60	115/22
30-512080-0	80	115/22
30-512010-0	100	115/22
30-512012-0	120	115/22

Schleifscheibe auf Papierunterlage

- für die Holz- und Metallbearbeitung
- selbsthaftend

Paper disc

- usable for wood and metal work
- self-adhesive



Bestell-Nr. Order-no.	Körnung Grit	Ø mm Ø mm
30-512640-0	40	115
30-512660-0	60	115
30-512680-0	80	115
30-512612-0	120	115
30-512618-0	180	115
30-512624-0	240	115

Fiberscheibe für rostfreien Stahl

- auch für andere Metalle geeignet
- mit Schlitzloch

Fibre disc for stainless steel

- also for various kinds of metals usable
- with slotted hole



Bestell-Nr. Order-no.	Körnung Grit	Ø mm Ø mm
30-512524-0	24	115/22
30-512536-0	36	115/22
30-512540-0	40	115/22
30-512550-0	50	115/22
30-512560-0	60	115/22
30-512580-0	80	115/22
30-512510-0	100	115/22
30-512512-0	120	115/22

Schleifscheibe auf Gewebeunterlage

- für rostfreien Stahl und andere Metallbearbeitung
- selbsthaftend

Webbing disc

- usable for stainless steel and other metal work
- self-adhesive



Bestell-Nr. Order-no.	Körnung Grit	Ø mm Ø mm
30-512740-0	40	115
30-512760-0	60	115
30-512780-0	80	115
30-512712-0	120	115

DIAMANT-Trennscheibe

zum Schneiden von Fliesen und Keramik

DIAMOND saw blade

continuous rim FL useable for tiles and ceramics



Bestell-Nr. Order-no.	Ø x Bohrung mm Ø x bore mm	Segmentgröße mm segment size mm
30-513002-9	115 x 22,2	5 x 1,4
30-513003-9	125 x 22,2	5 x 1,4
30-513006-9	150 x 22,2	5 x 1,4
30-513004-9	180 x 22,2	5 x 1,6
30-513005-9	230 x 22,2	5 x 2,4

DIAMANT-Trennscheibe

- für Steine und leichten Beton
- Blatt segmentiert

DIAMOND saw blade

- blade segmented
- SEU
- useable for stone and light reinforced concrete



Bestell-Nr. Order-no.	Ø x Bohrung mm Ø x bore mm	Segmentgröße mm segment size mm
30-515011-9	115 x 22,2	1,8 x 10
30-515012-9	125 x 22,2	1,8 x 10
30-515015-9	150 x 22,2	2,0 x 10
30-515018-9	180 x 22,2	2,4 x 10
30-515023-9	230 x 22,2	2,4 x 10

DIAMANT-Trennscheibe TURBO

- zum Schneiden von Dachziegel Kunst- und Natursteine

DIAMOND saw blade TURBO TBA

- useable for roof tile cast stone and natural stone



Bestell-Nr. Order-no.	Ø x Bohrung mm Ø x bore mm	Segmentgröße mm segment size mm
30-514011-9	115 x 22,2	2,0 x 10
30-514012-9	125 x 22,2	2,0 x 10
30-514018-9	180 x 22,2	2,6 x 10
30-514023-9	230 x 22,2	3,2 x 10

DIAMANT-Trennscheibe

- Blatt segmentiert
- für Beton und harte Mauersteine

DIAMOND saw blade

- blade segmented
- SEB
- for beton and reinforced concrete



Bestell-Nr. Order-no.	Ø x Bohrung mm Ø x bore mm	Segmentgröße mm segment size mm
30-516011-9	115 x 22,2	1,8 x 10
30-516012-9	125 x 22,2	1,8 x 10
30-516015-9	150 x 22,2	2,0 x 10
30-516018-9	180 x 22,2	2,4 x 10
30-516023-9	230 x 22,2	2,4 x 10

DIAMANT-Trennscheibe RESCUE-TRINITY

- Trockenschnitt
- für Winkelschleifer
- zum Schneiden von jeglicher Arten von Eisen
Bahngleisen
Leitplanken
Sicherheitsglas
Kunststoffe
Eis

DIAMOND saw blade RESCUE-TRINITY

- dry cutting with Angel grinder
- blade cuts all kind of iron
track
guide rail
safety glass
plastics
ice bar etc.



Bestell-Nr. Order-no.	Ø mm Ø mm	Blattstärke x Bohrung mm thickness x bore mm
30-517125-9	125	2,4 x 22,2
30-517230-9	230	2,6 x 22,2
30-517300-9	300	3,0 x 20,0
30-517301-9	300	3,0 x 25,4
30-517350-9	350	3,4 x 20,0
30-517351-9	350	3,4 x 25,4



Trennscheibe für Stein

- gekröpft
- für tragbare Geräte
- geeignet für Beton, Steine, Dachziegel, Kalksandsteine etc.

Cutting disc for stone

- offset
- for portable machines
- for cutting beton, stones, roof tiles etc.



Bestell-Nr. Order-no.	Ø x Stärke mm Ø x strength mm	Normbohrung mm bore mm
30-520011-0	115 x 3	22,2
30-520012-0	125 x 3	22,2
30-520018-0	180 x 3	22,2
30-520023-0	230 x 3	22,2

Schruppscheibe für Metall

- gekröpft
- für tragbare tragbare Geräte
- zum Schleifen von diversen Metalloberflächen etc.

Grinding disc for metal

- offset
- for portable machines
- for grinding all types of various metal surfaces

Bestell-Nr. Order-no.	Ø x Stärke Ø x strength mm	Normbohrung mm bore mm
30-521011-0	115 x 6	22,2
30-521012-0	125 x 6	22,2
30-521018-0	180 x 6	22,2
30-521023-0	230 x 6	22,2



Trennscheibe INOX

- für tragbare Geräte
- zum Schneiden von rostfreien Materialien
- gerade (180 und 230 mm gekröpft)

Cutting disc INOX

- for portable machines
- for cutting various stainless steel materials
- straight (180 and 230 mm offset)

Bestell-Nr. Order-no.	Ø x Stärke Ø x strength mm	Normbohrung mm bore mm
30-522011-0	115 x 1	22,2
30-522012-0	125 x 1	22,2
30-522013-0	115 x 1,6	22,2
30-522018-0	180 x 1,6	22,2
30-522023-0	230 x 1,9	22,2



Trennscheibe für Metall

- gekröpft
- für tragbare Geräte
- geeignet zum Schneiden von einfachen Metallarten

Cutting disc for metal

- offset
- for portable machines
- for cutting all simple types of metal

Bestell-Nr. Order-no.	Ø x Stärke Ø x strength mm	Normbohrung mm bore mm
30-523011-0	115 x 3	22,2
30-523012-0	125 x 3	22,2
30-523018-0	180 x 3	22,2
30-523023-0	230 x 3	22,2



Trennscheibe für Metall

- gerade
- für stationäre Trennmaschine
- zum Schneiden von diversen Metallmaterialien

Cutting disc for metal „CHOP SAW“

- straight
- for stationary machines
- for cutting various material made of steel

Bestell-Nr. Order-no.	Ø x Stärke Ø x strength mm	Normbohrung mm bore mm
30-524000-0	350 x 3	25,4



Trennscheibe für Stein, gerade

- für tragbare Geräte
- geeignet für Beton, Steine, Dachziegel, Kalksandsteine etc.

Cutting disc for stone, straight

- for portable machines
- for cutting beton, stones, roof tiles etc.

Bestell-Nr. Order-no.	Ø x Stärke Ø x strength mm	Normbohrung mm bore mm
30-525011-0	115 x 3	22,2
30-525012-0	125 x 3	22,2
30-525018-0	180 x 3	22,2
30-525023-0	230 x 3	22,2



Trennscheiben für Metall, gerade

- für tragbare Geräte
- geeignet zum Schneiden von einfachen Metallarten

Cutting disc for metal, straight

- for portable machines
- for cutting all simple types of metal

Bestell-Nr. Order-no.	Ø x Stärke Ø x strength mm	Normbohrung mm bore mm
30-525111-0	115 x 3	22,2
30-525112-0	125 x 3	22,2
30-525118-0	180 x 3	22,2
30-525123-0	230 x 3	22,2



Schleifscheibenabrichter

- aus Stahl
- mit 5 Rädchen
- mit Holzgriff

Redressing tool

- with 5 wheels
- wooden handle



Bestell-Nr. Order-no.	Ø-Rädchen mm Ø-wheel mm	Anzahl Rädchen Number of wheels
30-526033-0	33	5
30-526040-0	40	5
30-527050-0	50	8
30-528033-0	33-Ersatzrädchen/spare wheels	100 Stück/pieces
30-528040-0	40-Ersatzrädchen/spare wheels	100 Stück/pieces
30-529050-0	50-Ersatzrädchen/spare wheels	100 Stück/pieces

Handschlagstempelsatz

- rund
- mit Tiefenbegrenzung
- scharf graviert
- Schrift nach DIN 1451
- in Kunststoffdose

Steel punch set

- round
- with depth stop
- face accord. to DIN 1451
- in plastic box



Bestell-Nr. Order-no.	Ausführung Execution	Schriftgröße mm character height mm	Satz teilig Pieces/Set
30-530002-0	A-Z	2	27
30-530003-0	A-Z	3	27
30-530004-0	A-Z	4	27
30-530005-0	A-Z	5	27
30-530006-0	A-Z	6	27
30-530007-0	A-Z	7	27
30-530008-0	A-Z	8	27
30-530010-0	A-Z	10	27

Bestell-Nr. Order-no.	Ausführung Execution	Schriftgröße mm character height mm	Satz teilig Pieces/Set
30-534002-0	0-9	2	9
30-534003-0	0-9	3	9
30-534004-0	0-9	4	9
30-534005-0	0-9	5	9
30-534006-0	0-9	6	9
30-534007-0	0-9	7	9
30-534008-0	0-9	8	9
30-534010-0	0-9	10	9

Handschlagstempelsatz

- mit angespitzter Sichtkante
- scharf graviert
- Schrift nach DIN 1451
- in Kunststoffdose

Steel punch set

- with sight edge (pointed)
- face accord. to DIN 1451
- in plastic box



Bestell-Nr. Order-no.	Ausführung Execution	Schriftgröße mm character height mm	Satz teilig Pieces/Set
30-531002-0	A-Z	2	27
30-531003-0	A-Z	3	27
30-531004-0	A-Z	4	27
30-531005-0	A-Z	5	27
30-531006-0	A-Z	6	27
30-531007-0	A-Z	7	27
30-531008-0	A-Z	8	27
30-531010-0	A-Z	10	27
30-531012-0	A-Z	12	27
30-531015-0	A-Z	15	27

Bestell-Nr. Order-no.	Ausführung Execution	Schriftgröße mm character height mm	Satz teilig Pieces/Set
30-535002-0	0-9	2	9
30-535003-0	0-9	3	9
30-535004-0	0-9	4	9
30-535005-0	0-9	5	9
30-535006-0	0-9	6	9
30-535007-0	0-9	7	9
30-535008-0	0-9	8	9
30-535010-0	0-9	10	9
30-535012-0	0-9	12	9
30-535015-0	0-9	15	9

Handschlagstempelsatz

- griechische Buchstaben
- rund
- mit Tiefenbegrenzung
- scharf graviert
- in Kunststoffdose

Greek Steel letter set

- round
- with depth stop
- face accord. to DIN 1451
- in plastic box



Bestell-Nr. Order-no.	Ausführung Execution	Schriftgröße mm character height mm	Satz teilig Pieces/Set
30-538002-0	griechisch/greek	2	24
30-538003-0	griechisch/greek	3	24
30-538004-0	griechisch/greek	4	24
30-538005-0	griechisch/greek	5	24
30-538006-0	griechisch/greek	6	24
30-538007-0	griechisch/greek	7	24
30-538008-0	griechisch/greek	8	24
30-538010-0	griechisch/greek	10	24
30-538012-0	griechisch/greek	12	24



Signierschablonensatz

- aus Zinkblech 0,3 mm stark

Stencil plate set

- made of zinc plate 0,3 mm thickness



Bestell-Nr.	Ausführung	Schriftgröße mm	Satz teilig
Order-no.	Execution	character height mm	Pieces/Set
30-540002-0	griechisch/greek letters	20	25
30-540003-0	griechisch/greek letters	30	25
30-540004-0	griechisch/greek letters	40	25
30-540005-0	griechisch/greek letters	50	25
30-540006-0	griechisch/greek letters	60	25
30-540008-0	griechisch/greek letters	80	25
30-540010-0	griechisch/greek letters	100	25
30-540012-0	griechisch/greek letters	120	25
30-540015-0	griechisch/greek letters	150	25
30-540020-0	griechisch/greek letters	200	25
30-544002-0	hebräisch/hebrew letters	20	26
30-544003-0	hebräisch/hebrew letters	30	26
30-544004-0	hebräisch/hebrew letters	40	26
30-544005-0	hebräisch/hebrew letters	50	26
30-544006-0	hebräisch/hebrew letters	60	26
30-544008-0	hebräisch/hebrew letters	80	26
30-544010-0	hebräisch/hebrew letters	100	26
30-544012-0	hebräisch/hebrew letters	120	26
30-544015-0	hebräisch/hebrew letters	150	26
30-544020-0	hebräisch/hebrew letters	200	26

Signierschablonensatz

- aus Zinkblech 0,3 mm stark
- Schriftbild nach DIN 1451

Stencil plate set

- made of zinc plate 0,3 mm thickness
- face accord. to DIN 1451



Bestell-Nr.	Ausführung	Schriftgröße mm	Satz teilig
Order-no.	Execution	character height mm	Pieces/Set
30-541002-0	A-Z	20	27
30-541003-0	A-Z	30	27
30-541004-0	A-Z	40	27
30-541005-0	A-Z	50	27
30-541006-0	A-Z	60	27
30-541008-0	A-Z	80	27
30-541010-0	A-Z	100	27
30-541012-0	A-Z	120	27
30-541015-0	A-Z	150	27
30-541020-0	A-Z	200	27
30-542002-0	0-9	20	10
30-542003-0	0-9	30	10
30-542004-0	0-9	40	10
30-542005-0	0-9	50	10
30-542006-0	0-9	60	10
30-542008-0	0-9	80	10
30-542010-0	0-9	100	10
30-542012-0	0-9	120	10
30-542015-0	0-9	150	10
30-542020-0	0-9	200	10
30-543002-0	a-z	20	27
30-543003-0	a-z	30	27
30-543004-0	a-z	40	27
30-543005-0	a-z	50	27
30-543006-0	a-z	60	27
30-543008-0	a-z	80	27
30-543010-0	a-z	100	27
30-543012-0	a-z	120	27
30-543015-0	a-z	150	27
30-543020-0	a-z	200	27

Karabinerhaken

- verzinkte Ausführung
- nach DIN 5299C

Snap hook

- galvanized
- accord. to DIN 5299C



Bestell-Nr. Order-no.	Länge x Breite mm Length x width mm
30-550004-9	40 x 4
30-550005-9	50 x 5
30-550006-9	60 x 6
30-550007-9	70 x 7
30-550008-9	80 x 8
30-550009-9	90 x 9
30-550010-9	100 x 10
30-550012-9	120 x 11
30-550014-9	140 x 12

Simplexhaken

- mit Wirbel
- aus Stahl
- vernickelt

Snap hooks simplex

- with swivel
- all steel
- nickel plated



Bestell-Nr. Order-no.	Abmessung mm Size mm
30-553125-9	25
30-553130-9	30
30-553140-9	40
30-553150-9	50
30-553160-9	60
30-553170-9	70
30-553180-9	80
30-553190-9	90
30-553110-9	100
30-553112-9	120

Wirbel

- Temperguss
- vernickelt

Swivel

- malleable cast iron
- nickel plated



Bestell-Nr. Order-no.	Abmessung mm Size mm
30-553045-9	45
30-553060-9	60
30-553070-9	70
30-553080-9	80

Wirbel

- Zinkdruckguss
- vernickelt

Swivel

- zinc die cast
- nickel plated



Bestell-Nr. Order-no.	für Kartusche mm for Cartridge mm
30-553513-9	13 x 13
30-553520-9	20 x 20
30-553525-9	25 x 25

Schäkel

- gerade Form
- verzinkt

Shakle

- straight
- galvanized



Bestell-Nr. Order-no.	Bügel Ø mm-Zoll bow Ø mm-inch	Weite x Länge mm Width x length mm
30-555005-9	5-3/16	10 x 20
30-555006-9	6-1/4	12 x 24
30-555008-9	8-5/16	16 x 32
30-555010-9	10-3/8	20 x 40
30-555011-9	11-7/16	22 x 44
30-555013-9	13-1/2	24 x 48
30-555014-9	14-9/16	28 x 56
30-555016-9	16-5/8	32 x 64
30-555019-9	19-3/4	38 x 76
30-555022-9	22-7/8	44 x 88
30-555026-9	25-1	50 x 100

Drahtseilklemme

- ähnlich DIN 741
- verzinkt

Wire rope clip

- accord. to DIN 741
- galvanized



Bestell-Nr. Order-no.	für Seil Ø mm-Zoll for rope Ø mm-inch
30-557003-9	3-1/8
30-557005-9	5-3/16
30-557006-9	6-1/4
30-557008-9	8-5/16
30-557010-9	10-3/8
30-557011-9	11-7/16
30-557013-9	13-1/2
30-557014-9	14-9/16
30-557016-9	16-5/8
30-557019-9	19-3/4
30-557022-9	22-7/8
30-557026-9	26-1

Seilspannklemme

- für Kupfer und Stahlseile
- verzinkt

Come along clamp

- for copper and steel ropes
- galvanized



Bestell-Nr. Order-no.	Seilquerschnitt mm ² wire cross section mm ²	für Draht Ø mm for wire Ø mm
30-560001-0	1-16	1-5
30-560006-0	6-35	3-9
30-560016-0	16-70	4-12
30-560050-0	50-150	6-18
30-560090-0	90-400	10-28

Froschklemme

- verzinkt
- zum Spannen von Seilen und Drähten

Wire stretcher

- zinc plated
- for stretching ropes and wires



Bestell-Nr. Order-no.	Spannweite Ø mm capacity Ø mm
30-561003-0	1-3
30-561004-0	1-4
30-561005-0	1-5
30-561008-0	1-8
30-561012-0	1-12
30-561018-0	5-18

Türscharnier

- gerade
- gesandstrahlt

Coach hinges

- straight
- sand plasted



Bestell-Nr. Order-no.	Abmessung mm size mm
30-564001-0	50 x 80 x 5
30-564002-0	50 x 80 x 6
30-564003-0	50 x 100 x 5
30-564004-0	50 x 100 x 6

Kartuschenpistole

- Standard
- für Silikonkartusche
- aus Metall

Caulking gun

- standard
- for silicone cartridge
- made of all metal



Bestell-Nr.
Order-no.

30-570000-9

für Kartusche mm
for Cartridge mm

225

Kartuschenpistole INDUSTRIAL

- schwere Ausführung
- für Silikonkartusche

Caulking gun INDUSTRIAL

- heavy pattern
- for silicone cartridge



Bestell-Nr.
Order-no.

30-571500-9

für Kartusche mm
for Cartridge mm

225

Kartuschenpistole PROFI

- schwere Ausführung
- für Silikonkartusche

Caulking gun PROFI

- heavy pattern
- for silicone cartridge



Bestell-Nr.
Order-no.

30-571000-9

für Kartusche mm
for Cartridge mm

225

Kartuschenpistole PROFI-Schub

- für Kartuschen und Schlauchbeutel
- aus Vollaluminium

Caulking gun PROFI

- for silicone cartridges and tubular bag
- body made of aluminium



Bestell-Nr.
Order-no.

30-572000-9

Artikel
Item

600 ml

30-572001-9

Ersatzdüse/spare nozzle

30-572002-9

Ersatzkappe/spare cover

30-572003-9

Ersatzdüse 45° schwenkbar/
spare nozzle 45° movable

Gummi-Schleifklotz**Rubber grinding block**

Bestell-Nr.
Order-no.

30-573000-9

Länge x Breite mm
Length x width mm

120 x 70

Standardfettpresse PRESSOL

- mit Düsenrohr M 10 x 1
- Hydraulik-Mundstück mit 4 Backen

Standard greas gun PRESSOL

- with spout
- angled M 10 x 1
- hydraulic coupler with 4 jaws



Bestell-Nr.
Order-no.

30-600000-0

Füllmenge
capacity

500 cm³

Handschleifblock

mit Einspannvorrichtung aus Metall

Hand grinding block

with metal clamping tool



Bestell-Nr.
Order-no.

30-574010-9

30-574020-9

Länge x Breite mm
Length x width mm

160 x 80

210 x 105

Hydraulik-Mundstück

- M 10 x 1 mit SF
- Ø 15 mm
- mit 4 Backen

Hydraulic coupler

- M 10 x 1 female
- with SF
- Ø 15 mm
- with 4 claws



Bestell-Nr.
Order-no.

30-600631-0

**Hochdruck-Panzerschlauch**

M 10 x 1a

High pressure hose

M 10 x 1 male



Bestell-Nr.
Order-no.

30-600656-0

Abmessung
Size

8 x 300 mm

Schlossriegel

- mit Schlaufe
- verzinkt

Door bolt

- with staple
- galvanized

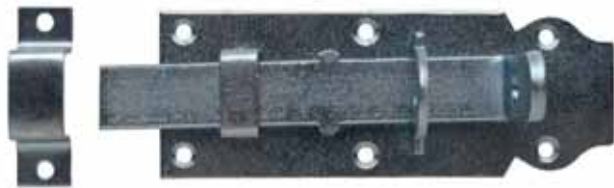

Bestell-Nr. Order-no.	Länge mm Length mm
30-623010-9	100
30-623012-9	120
30-623014-9	140
30-623016-9	160

Vollleder-Arbeitshandschuhe

- mit leichtem Innenfutter
- glattes Leder

Leather working gloves

- with lining
- smooth leather



Bestell-Nr. Order-no.	Größe size
30-631000-9	10

Nitril 5-Finger-Handschuh EN 388

- Strickbund
- gelb beschichtet

Nitril 5-finger gloves EN 388

- yellow coated
- knitting bunch



Bestell-Nr. Order-no.	Größe size
30-630000-9	10

Arbeitsschutzhelm CE-EN 397

- mit Kopfband verstellbar
- mit Schweißband

Workers protection CE-EN 397

- with adjustable headband
- with sweatband



Bestell-Nr. Order-no.	Farbe colour
30-633010-0	gelb/yellow
30-633020-0	blau/blue
30-633030-0	weiß/white
30-633040-0	rot/red

Falzzange

- gerade
- lackiert
- aufgelegt
- Chrom-Vanadium

Tinner's pliers

- straight
- lap joint
- varnished
- Chrom-Vanadium



Bestell-Nr. Order-no.	Maulbreite mm jaw width	Gesamtlänge mm total length mm
30-635040-0	40	280
30-635060-0	60	280
30-635080-0	80	300

Falzzange

- 45° gebogen
- lackiert
- aufgelegt
- Chrom-Vanadium

Tinner's pliers

- 45° bent
- lap joint
- varnished
- Chrom-Vanadium



Bestell-Nr. Order-no.	Maulbreite mm jaw width	Gesamtlänge mm total length mm
30-636040-0	40	280
30-636060-0	60	280
30-636080-0	80	300

Wolfsmaul-Schmiedezange

- schwarz lackiert

Blacksmith's tongs

- wolf jaw
- black painted



Bestell-Nr. Order-no.	Maulweite mm Opening mm	Gesamtlänge mm Total length mm
30-640030-0	6	300
30-640040-0	8	400
30-640050-0	12	500



Flachmaul-Schmiedezange

- schwarz lackiert

Blacksmith's tongs

- straight lip
- black painted



Bestell-Nr. Order-no.	Maulweite mm Opening mm	Gesamtlänge mm Total length mm
30-641030-0	6	300
30-641040-0	8	400
30-641050-0	10	500

Rundmaul-Schmiedezange

- schwarz lackiert

Blacksmith's tongs

- hollow lip
- black painted



Bestell-Nr. Order-no.	Maulweite mm Opening mm	Gesamtlänge mm Total length mm
30-642030-0	8	300
30-642040-0	12	400
30-642050-0	16	500

Stahlnägel

- mit Linsenkopf
- gehärtet
- blau
- 100 Stück im Polybeutel
- 1.000 Stück in Schachtel

Steel nails

- fillister head
- blue
- hardened
- 100 pieces in bag
- 1.000 pieces in box



Bestell-Nr. Order-no.	Ø x Länge mm Ø x length mm
30-650030-0	1,2 x 20
30-650031-0	1,2 x 25
30-650033-0	1,2 x 35
30-650035-0	1,4 x 45
30-650000-0	2,0 x 16
30-650001-0	2,0 x 20
30-650002-0	2,0 x 23
30-650003-0	3,0 x 25
30-650004-0	2,0 x 30
30-650005-0	2,0 x 40
30-650006-0	2,5 x 20
30-650007-0	2,5 x 25
30-650008-0	2,5 x 30
30-650009-0	2,5 x 40
30-650013-0	3,0 x 40
30-650014-0	3,0 x 50
30-650015-0	3,0 x 60
30-650016-0	3,0 x 70
30-650023-0	3,5 x 50
30-650024-0	3,5 x 60
30-650026-0	3,5 x 70
30-650018-0	4,0 x 50
30-650019-0	4,0 x 60
30-650020-0	4,0 x 70

Stahlnägel

- gerillt
- gehärtet
- verzinkt
- 250 Stück in Schachtel

Grooved steel nails

- hardened
- zinc plated
- 250 pieces in box



Bestell-Nr. Order-no.	Ø x Länge mm Ø x length mm	Bestell-Nr. Order-no.	Ø x Länge mm Ø x length mm
30-651001-0	2,7 x 20	30-651020-0	4,5 x 30
30-651002-0	2,7 x 25	30-651021-0	4,5 x 40
30-651003-0	2,7 x 30	30-651022-0	4,5 x 50
30-651004-0	2,7 x 35	30-651023-0	4,5 x 55
30-651005-0	2,7 x 40	30-651024-0	4,5 x 60
30-651006-0	2,7 x 50	30-651025-0	4,5 x 65
30-651007-0	2,7 x 60	30-651026-0	4,5 x 70
30-651008-0	2,7 x 70	30-651027-0	4,5 x 75
30-651009-0	2,7 x 80	30-651028-0	4,5 x 80
30-651010-0	3,5 x 35	30-651029-0	4,5 x 90
30-651011-0	3,5 x 40	30-651030-0	4,5 x 100
30-651012-0	3,5 x 45	30-651031-0	6,0 x 55
30-651013-0	3,5 x 50	30-651032-0	6,0 x 65
30-651014-0	3,5 x 55	30-651033-0	6,0 x 75
30-651015-0	3,5 x 60	30-651034-0	6,0 x 85
30-651016-0	3,5 x 65	30-651035-0	6,0 x 100
30-651017-0	3,5 x 70	30-651036-0	6,0 x 120
30-651018-0	3,5 x 75	30-651037-0	6,0 x 150
30-651019-0	3,5 x 80		

S-FIX Keile

in Schachtel zu 100 Stück verpackt

S-FIX wedges

box of 100 pieces

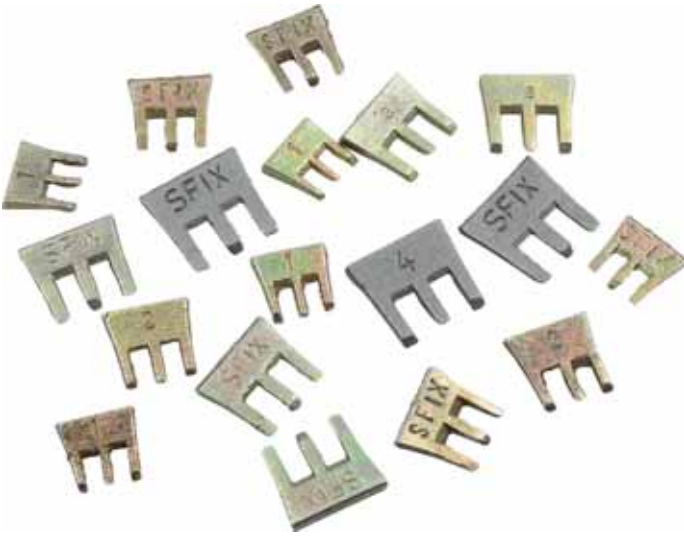

Bestell-Nr. Order-no.	Größe/Breite mm Size/Width mm
30-652013-0	0-13
30-652016-0	0-16
30-652020-0	1-20
30-652023-0	2-23
30-652026-0	3-26
30-652029-0	4-29
30-652032-0	5-32

**Rundstahlhaken**

- gerillt
- verzinkt
- 100 Stück in Schachtel

Round steel hooks

- grooved
- zinc plated
- 100 pieces in box



Bestell-Nr. Order-no.	Ø x Länge mm Ø x length mm
30-661001-0	3,0 x 30
30-661002-0	4,0 x 40
30-661003-0	4,0 x 50
30-661004-0	4,0 x 60
30-661005-0	4,0 x 70
30-661006-0	4,0 x 75
30-661007-0	5,0 x 60
30-661008-0	5,0 x 75
30-661009-0	5,0 x 90
30-661010-0	5,0 x 100





Stichsägeblätter

Aufnahme:	
AEG/BOSCH/METABO	350-351
MAKITA	352
BLACK&DECKER	353-354

Jig saw blades

Connection:	
AEG/BOSCH/METABO	350-351
MAKITA	352
BLACK&DECKER	353-354



Lochsägen

Lochsäge BI-Cobalt	355
Zubehör	355

Hole saws

Hole saw BI-Cobalt	355
Accessories	355

Stichsägeblatt namhafter Markenhersteller

- jeweils verpackt im praktischen Blister

Jig saw blade from major brands

- each packed in practical blister



Stichsägeblatt AEG/BOSCH/METABO

- feiner Schnitt
- für Weichholz, Sperrholz und Multiplex-Tischlerplatten
- 5 Stück im Satz

Jig saw blade AEG/BOSCH/METABO

- clean and straight cutting
- for soft construction ply- and multiplex/glued wood
- 5 pieces in set

Bestell-Nr.
Order-no.

31-3101-0

Schneidenlänge x Gesamtlänge mm
Cutting length x total length mm

75 x 100

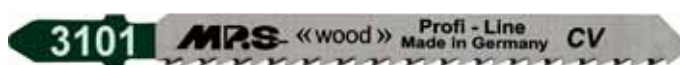

Stichsägeblatt AEG/BOSCH/METABO

- splitterfreier Schnitt
- für Weichholz, Sperrholz- und Küchenarbeitsplatten
- 5 Stück im Satz

Jig saw blade AEG/BOSCH/METABO

- clean and splinterfree cutting
- for soft construction plywood and laminated board/kitchen worktops
- 5 pieces in set

Bestell-Nr.
Order-no.

31-3102-0

Schneidenlänge x Gesamtlänge mm
Cutting length x total length mm

75 x 100

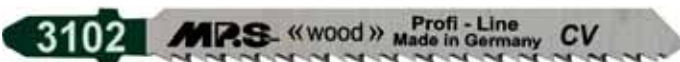

Stichsägeblatt AEG/BOSCH/METABO

- schneller Schnitt
- für Weichholz, Sperrholz und Multiplex-Tischlerplatten
- 5 Stück im Satz

Jig saw blade AEG/BOSCH/METABO

- fast cutting
- for soft construction ply- and multiplex/glued wood
- 5 pieces in set

Bestell-Nr.
Order-no.
31-3104-0

Schneidenlänge x Gesamtlänge mm
Cutting length x total length mm
75 x 100



Stichsägeblatt AEG/BOSCH/METABO

- rauher Schnitt
- für Weichholz, Sperrholz und Multiplex-Tischlerplatten
- 5 Stück im Satz

Jig saw blade AEG/BOSCH/METABO

- rough cutting
- for soft construction ply- and multiplex/glued wood
- 5 pieces in set

Bestell-Nr.
Order-no.
31-3106-0

Schneidenlänge x Gesamtlänge mm
Cutting length x total length mm
75 x 100



Stichsägeblatt AEG/BOSCH/METABO

- gerader Schnitt
- für die Metallbearbeitung, diverse Stahlbleche
- feine Zahnung
- 5 Stück im Satz

Jig Saw blade AEG/BOSCH/METABO

- straight cutting
- for metal cutting, various sheet steel
- fine toothing
- 5 pieces in set

Bestell-Nr.
Order-no.
31-3111-0

Schneidenlänge x Gesamtlänge mm
Cutting length x total length mm
50 x 75



Stichsägeblatt-AEG/BOSCH/METABO

- gerader Schnitt
- für die Metallbearbeitung, diverse Stahlbleche
- grobe Zahnung
- 5 Stück im Satz

Jig Saw blade AEG/BOSCH/METABO

- straight cutting
- for metal cutting, various sheet steel
- rough toothing
- 5 pieces in set

Bestell-Nr.
Order-no.
31-3113-0

Schneidenlänge x Gesamtlänge mm
Cutting length x total length mm
50 x 75



Universal-Stichsägeblatt AEG/BOSCH/METABO

- für Holz- und Metallschnitte
- für Weich- und Hartholz, Holz mit Nägeln
- für diverse Metalle/Stahl
- rostfreier Stahl
- 5 Stück im Satz



Universal jig saw blade AEG/BOSCH/METABO

- soft and hard wood, wood with nails
- various metals /steel
- stainless steel
- 5 pieces in set

Bestell-Nr.
Order-no.
31-3150F-0

Schneidenlänge x Gesamtlänge mm
Cutting length x total length mm
110 x 132

Stichsägeblatt MAKITA

- feiner Schnitt
- für Weichholz, Sperrholz und Multiplex-Tischlerplatten
- 5 Stück im Satz

Bestell-Nr.
Order-no.
31-3301-0

Schneidenlänge x Gesamtlänge mm
Cutting length x total length mm
75 x 100

Jig saw blade MAKITA

- clean and straight cutting
- for soft construction ply- and multiplex/glued wood
- 5 pieces in set

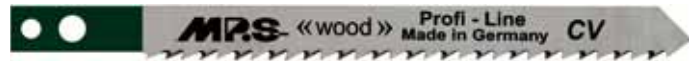

Stichsägeblatt MAKITA

- splitterfreier Schnitt
- für Weichholz, Sperrholz und Küchenarbeitsplatten
- 5 Stück im Satz

Bestell-Nr.
Order-no.
31-3302-0

Schneidenlänge x Gesamtlänge mm
Cutting length x total length mm
75 x 100

Jig saw blade MAKITA

- clean and splinterfree cutting
- for soft construction plywood and laminated board/
kitchen worktops
- 5 pieces in set

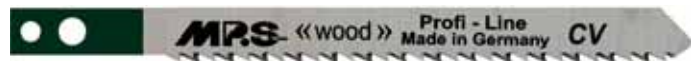

Stichsägeblatt MAKITA

- rauer Schnitt
- für Weichholz, Sperrholz und Multiplex-Tischlerplatten
- 5 Stück im Satz

Bestell-Nr.
Order-no.
31-3306-0

Schneidenlänge x Gesamtlänge mm
Cutting length x total length mm
75 x 100

Jig saw blade MAKITA

- rough cutting
- for soft construction ply- and multiplex/glued wood
- 5 pieces in set



Stichsägeblatt MAKITA

- gerader Schnitt
- für die Metallbearbeitung, diverse Stahlbleche
- feine Zahnung
- 5 Stück im Satz

Bestell-Nr.
Order-no.
31-3311-0

Schneidenlänge x Gesamtlänge mm
Cutting length x total length mm
50 x 75

Jig saw blade MAKITA

- straight cutting
- for metal cutting, various sheet steel
- fine toothing
- 5 pieces in set



Stichsägeblatt BLACK & DECKER

- feiner Schnitt
- für Weichholz, Sperrholz und Multiplex-Tischlerplatten
- 5 Stück im Satz

Bestell-Nr.
Order-no.
31-3401-0

Schneidenlänge x Gesamtlänge mm
Cutting length x total length mm
75 x 100

Jig saw blade BLACK & DECKER

- clean and straight cutting
- for soft construction ply- and multiplex/glued wood
- 5 pieces in set

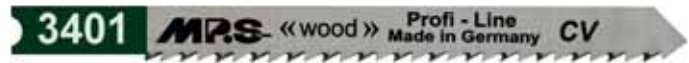

Stichsägeblatt BLACK & DECKER

- splitterfreier Schnitt
- für Weichholz, Sperrholz- und Küchenarbeitsplatten
- 5 Stück im Satz

Bestell-Nr.
Order-no.
31-3402-0

Schneidenlänge x Gesamtlänge mm
Cutting length x total length mm
75 x 100

Jig saw blade BLACK & DECKER

- clean and splinterfree cutting
- for soft construction plywood and laminated board/kitchen worktops
- 5 pieces in set

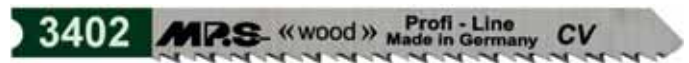

Stichsägeblatt BLACK & DECKER

- schneller Schnitt
- für Weichholz, Sperrholz und Multiplex-Tischlerplatten
- 5 Stück im Satz

Bestell-Nr.
Order-no.
31-3404-0

Schneidenlänge x Gesamtlänge mm
Cutting length x total length mm
75 x 100

Jig saw blade BLACK & DECKER

- fast cutting
- for soft construction ply- and multiplex/glued wood
- 5 pieces in set



Stichsägeblatt BLACK & DECKER

- rauer Schnitt
- für Weichholz, Sperrholz und Multiplex-Tischlerplatten
- 5 Stück im Satz

Bestell-Nr.
Order-no.
31-3406-0

Schneidenlänge x Gesamtlänge mm
Cutting length x total length mm
75 x 100

Jig saw blade BLACK & DECKER

- rough cutting
- for soft construction ply- and multiplex/glued wood
- 5 pieces in set



Stichsägeblatt BLACK & DECKER

- gerader Schnitt
- für die Metallbearbeitung, diverse Stahlbleche
- feine Zahnung
- 5 Stück im Satz

Bestell-Nr.
Order-no.
31-3411-0

Schneidenlänge x Gesamtlänge mm
Cutting length x total length mm
50 x 75

Jig saw blade BLACK & DECKER

- straight cutting
- for metal cutting, various sheet steel
- fine toothing
- 5 pieces in set



Stichsägeblatt BLACK & DECKER

- gerader Schnitt
- für die Metallbearbeitung, diverse Stahlbleche
- grobe Zahnung
- 5 Stück im Satz

Bestell-Nr.
Order-no.
31-3413-0

Schneidenlänge x Gesamtlänge mm
Cutting length x total length mm
50 x 75

Jig saw blade BLACK & DECKER

- straight cutting
- for metal cutting, various sheet steel
- rough toothing
- 5 pieces in set



Universal-Stichsägeblatt BLACK & DECKER

- für Holz- und Metallschnitte
- für Weich- und Hartholz, Holz mit Nägeln
- für diverse Metalle/Stahl
- rostfreier Stahl
- 5 Stück im Satz

Bestell-Nr.
Order-no.
31-3450F-0

Schneidenlänge x Gesamtlänge mm
Cutting length x total length mm
110 x 132

Universal jig saw blade BLACK & DECKER

- soft and hard wood, wood with nails
- various metals/steel
- stainless steel
- 5 pieces in set



Lochsäge BI-COBALT

4-6 Zähne per Zoll

Hole saw BI-COBALT

4-6 teeth per inch



Bestell-Nr. Order-no.	Loch Ø mm Hole Ø mm	Bestell-Nr. Order-no.	Loch Ø mm Hole Ø mm
31-500014-0	14	31-500060-0	60
31-500016-0	16	31-500063-0	63
31-500017-0	17	31-500064-0	64
31-500019-0	19	31-500065-0	65
31-500020-0	20	31-500067-0	67
31-500021-0	21	31-500068-0	68
31-500022-0	22	31-500070-0	70
31-500023-0	23	31-500073-0	73
31-500024-0	24	31-500076-0	76
31-500025-0	25	31-500079-0	79
31-500027-0	27	31-500083-0	83
31-500029-0	29	31-500086-0	86
31-500030-0	30	31-500089-0	89
31-500032-0	32	31-500092-0	92
31-500033-0	33	31-500095-0	95
31-500035-0	35	31-500098-0	98
31-500037-0	37	31-500102-0	102
31-500038-0	38	31-500105-0	105
31-500040-0	40	31-500108-0	108
31-500041-0	41	31-500111-0	111
31-500043-0	43	31-500114-0	114
31-500044-0	44	31-500121-0	121
31-500046-0	46	31-500127-0	127
31-500048-0	48	31-500133-0	133
31-500050-0	50	31-500140-0	140
31-500051-0	51	31-500146-0	146
31-500052-0	52	31-500152-0	152
31-500054-0	54	31-500160-0	160
31-500056-0	56	31-500168-0	168
31-500057-0	57	31-500177-0	177
31-500058-0	58	31-500200-0	200
31-500059-0	59	31-500210-0	210

Aufnahmeschaft für Lochsäge

sechskant

Arbour for hole saw

hex shank



Bestell-Nr. Order-no.	für Lochsägen Ø mm for hole saw Ø mm	Detail Detail
31-5503-9	14 - 30	-
31-5505-9	32 - 210	with pull system

Ersatz-Pilotbohrer

zu Aufnahmeschaft für Lochsäge

Pilot drill

for hole saw



Bestell-Nr. Order-no.	Länge x Ø mm Length x Ø mm
31-5507-9	83 x 6,35

Bi-Metall-Lochsägensortiment

- 8-teilig
- in Kassette
- 2 Aufnahmen

Bi-Metal hole saws assortment

- set of 8 pieces
- in case
- 2 Arbours



Bestell-Nr. Order-no.	Loch Ø mm Hole Ø mm
31-6000-9	22, 29, 35, 44, 57, 68

A		
Abisolierzange	41, 45	
Abisoliermesser	73-76	
Adaptersatz	81	
Aderendhülsenzange	54-55	
Aluminium-		
Auflegebacken	302	
Lineal	140	
Anschlagwinkel	134	
Arbeitsschutzhelm	343	
Armaturenschlüssel	26, 31-32	
Armaturen-Rohrzange	31	
Astsäge	154	
Aufnahmeschaft für Lochsäge	355	
Aufstecksenker	200	
Aufweitezange	30	
Ausbeulhammer	289	
Ausgießer	121	
Ausgußreiniger	35	
Außentaster	142	
Automatik-		
messer	230	
Schutzhelm	318	
AUTOSOL-Produkte	258-261	
Auto-Stromprüfer	68	
Axt	180	
B		
Baghdad Säge	153	
Band-		
maß	132-133	
säge	167	
schlüssel	103	
Batterie Montage Lehre	23	
Bau-		
säge	154-155	
schlüssel	25	
stopfen	23	
Beilstiel	180	
Beißzange	49, 50, 273	
Besenstiel	264	
Betonstahlblechschere VITTE	283	
Biegezange	27, 49, 273	
BIT-		
Schraubeinsatz	81-87	
Schraubendrehersatz	86-87	
Steckgriff-Schraubendreher	87	
Blech-		
locher	21	
scheren	276-279	
Blei-		
plombenzange	53	
rohr-Aufweitezange	30	
stift	136-137	
Blitz-Rohrzange	32	
Bodenträger-		
schienen	269	
Bogenzirkel	141	
Bohrstichsäge	157	
Brauseschlauch	252	
Breitmaul-Gripzange	328	
Bremsfederzange	105	
Brustbohrmaschine	203	
Bügel-		
gasanzünder	312	
säge	158	
C		
Crimpzange	55	
D		
Dachdecker-		
zangen	49, 273	
Nagel/Flickeisen	273	
Arbeitskelle	248	
Dämmstoffmesser	230	
Diagonalschneider	45	
DIAMANT-Trennscheibe	332-333	
Doppelblechlocher	21	
Draht-		
bürste	323-325	
seilklemme	340	
Dreh-		
momentschlüssel	103	
stange	102	
Drill Bindewerkzeug	80-81	
Druckminderer	315, 316	
Druck-Prüfpumpe	22	
Dübelzieher	157	
Durchschläger	292-293	
Düsen-		
lehre	149	
reibbahnen	201	
E		
Einmaulschlüssel	109	
Einzahnfräser	202	
Einziehband/-spirale	71-72	
Elastikteller	267	
Elektriker-		
messer	73-78	
Schraubendreher	58, 60-61, 64	
Elektrodenhalter	313	
Elektro-LötKolben	304-305, 307	
Elektronikzangen	42-43, 46-47	
Entgrater	20-21	
Entlötpumpe	304	
Entlüftungsschlüssel	25-26	
Erdklemme/Polklemme	315	
Ersatz-		
klingen JOKARI Kabelmesser	74	
kopf zu Plastikhammer	107	
Schneidrädchen	19-20, 223, 235	
F		
Fächerschleifer	330	
Fäustel	286	
Falzzange	344	
Farbpulver	229	
Farbrührer	226	
Feilen	173-179	
bürste	175	
heft	175	
satz	175	
Feilkloben	282-283	
Feinmechaniker-		
Sägebogen	162	
Schraubendreher	79-80	
Feinsäge	156	
Fettpresse	342	
Feuerwehrausrüstung	4	
Fiberscheibe	331	
Fitschenbeitel	168	
Fittingbürste	24	
FIT-Scherenzange	45	
Flächenspachtel	241-245	
Flach-		
fräsbohrer	218	
maul-Schmiedezeange	345	
schaber	298	
Flanschenwinkel	134	
Fleischhaken	160	
Fleisch- und Knochensäge	157	
Fliesen-		
feile	226	
kreuze + Keile	224	
lochsneider	223	
schneider	224	
schneidmaschine	222	
schwamm	227	
Forstnerbohrer	218	
Fräsapparat	22	
Freileitungsbauschlüssel	25	
Froschklemme	340	
Frostschutztester	105	
Fugen-		
gummi	224	
kratzer	226	
meißel	298	
FUGI Silikonglätter	227	
Fühler-		
lehre	146-147	
lehenband	148	
Funkenfreie Werkzeuge	4	
Furniersäge	155	
G		
Gabel-		
Ringschlüssel	108-111	
schlüssel	108-109	
Garniernadel	233	
Gasanzünder	312	
Gehrungs-		
Schneidlade	157	
säge	158	
Gelenkstück	254	
Gewinde-		
bohrer-Verlängerung	126	
dichtband	23	
feile	125	
schablone	147	

Gewinde-	
schneidkluppe	124
schneidsatz	129
stahllehre	147
Gipserbeil	288
Glas-	
bohrer	201
brechzange	241
schaber	238
schneider	234-237
Glättkelle	246-247
Glättfix	227
Goldschmiede-Schere	280
Gradmesser	137
Gripzangen	326-328
Gummi-	
gipsbecher	229
hammer	289

H

Hahnverlängerungsschlüssel	26
Haken-Klingen	231
Haken-schlüssel	111
Halter für Fühlerlehrenband	148
Hammer-	106-107, 284-289
bohrer	187, 189, 191, 206-210
Meißel	187-190, 209-211
Hand-	
brause	253
Drahtbürste	323
drillbohrer	203
Feilklobe	282-283
gewindebohrer	124-125, 129
säge	153-158, 160-162, 165
schlagstempelsatz	336-337
schleifblock	342
schuhe	343
schutz für Meißel	298
schutzschild	317
senker	200
waschpaste	261
Hanf-	
knäuel	24
spule	24
Hartlötpulver	311
Hebel-	
Seitenschneider	46
Vornschnaider	46
Heizkörper	
Entlüftungsschlüssel	26
zu LötKolben	305, 307
Henkelocheisen	290
Hochdruck-Panzerschlauch	342
Holz-	
axt	180
stiel	180
bandsägen	167
hammer	289
raspel	174, 178-179
spiralbohrer	197, 217
stiel	107, 180, 264, 286-287

Hydraulik-Mundstück	342
I	
ILSE Schnellspann-Schlüssel	31
Innentaster	142
J	
JAPAN Malerspachtelsatz	241
JOKARI Abisoliermesser	73-76
JUMBO Regler	316
K	
Kabel-	
binder	70
kupplung	314
messer	73-78
Schere	281
schuh-Sortiment	55
schuhpresszange	54-55
trennmesser	77
Kanister	121
Karabinerhaken	339
Karosserie-	
Feilenblatt	107
Feilenhalter	107
Kartuschenpistole	341
Keil	224, 347
Kellen	246-249
Ketten-Rohrzange	33
Ketten-	
sägefeile	173
schlüssel	104
Klaue für Mutternschlüssel	27
Klebe-	
pistole	308
stange	308
Klingen	231
Knarren	29, 114, 116-118
Knochensäge	157
Knopfmaß	145
Kolbenring-	
spannband	104
zange	104
Kombinationszange	40-41, 44-45
Kompressor	121
Kontaktfeile	175
Kontrollspiegel	326
Kopf-Schutzschirm	317
Kopf-/Stirnlampe	262
Körner	291-293
Kraftstoffkanister	121
Kreissägeblatt	170-172
Kreuz-	
hacke	264
schlüssel	24-25, 102
Kugelwindeisen	129
Kunststoff	
Plastikhammer	106
Rohrschere	18
Kupferhammer	285

Kuper-	
LötKolben	310
Rohrabschneider	18-20
rohr Biegezange	27

L

Ladezange	314
Lamellenschleifteller	329
Langlochbohrer	198
Latthammer	288
Laubsäge-	
blätter	162-163
bogen	162
Drillbohrer	163
sägesatz	164-165
tisch	163
zwinge	163
Lineal	140
Loch-	
bohrer	225, 355
eisen	290-291
säge	355
zange	50-52
Löffelschaber	299
Löt-	
draht	308-309
fett in Dosen	310
kolben	304-307, 310
stange	309
spitze zu LötKolben	307

M

Magnet-	
halter für Bits	88
Hebrewerkzeug	80
schlüssel am Ring	113
Malerspachtel	241-244
Maschinen	
Langlochbohrer	198
sägeblatt	167
Maßstab	140-141
Maulschlüssel	109
Maurer-	
kelle	246-249
Lotschnur	229
Mausefalle	271
Meißel	295-298
Messer	230-231
Metall-	
pflege	258-261
sägeblatt	161, 166-167
sägebogen	160-161, 165
Ziehklinge	242
Mikrometer	149
Montage-	
lehre	23
zange	48
Multimeter	69
Mundstück	342
Mutternschlüssel	26-27
Mutternzange	27

N		Riegel	343	Schlagstempel	336-337
Nägels	346	Ringschlüssel	110-111	Schlauch-	
Nagel-		Rinnenhalter-Biegezange	49, 273	schelle	265-266
bohrer	200	Rohr-		schellendreher	88
eisen	168, 273	abschneider	18-20	schere	30
heber	181	bearbeitung	17	Schleif-	
Nestsägen	155	biegezange	27	klotz	342
Nietzange	39	Einziehzange	31	scheibe	331
Nylon-		entgrater	20-21	scheibenabrichter	335
Einziehband	71-72	gewindeschneidkluppe	124	stein	169
Hammer	106	innenbürste	24	Schlosser-	
Schutzbrille	319, 321	reinigungswelle	35-36	hammer	284-285
		Schere	18, 30	winkel	134
		steckschlüssel	112-113	Schlossriegel	343
		zangen	31-35, 37	Schlüssel-	
O		Roll-		anhänger	268
Öldienstschlüssel	104	bandmaß	132-133	feilensatz	173
Öl-		feder	270	ring	268
filter-Schlüssel	103-104	gabelschlüssel	39	Schmiedezeange	344-345
wannenschlüssel	104	RUBIN Schlagbohrer	191	Schmiegenwinkel	135
Ösen-	51	Rücksäge	154	Schneid-	
zange	51	Rund-		eisen	126
		ahle	152	eisenhalter	127
		bürste	324-325	kopf zu Glasschneider	237
P		glasschneider	234	lade	156-157
Pack-/Speernadel	233	locheisen	291	rädchen	19-20, 223, 235
Panzerschlauch	342	maul-Schmiedezeange	345	Schnellspannschlüssel/Zange	31, 38
Pilotbohrer	355	stahlhaken	347	Schrauben-	
PIMETER Umfangbandmaß	149			ausdreher	201, 219
Pinself-Bastlerbürste	325	S		dreher	58-65, 69
Pinzette	78-79	Sackbinder/-driller	80-81	dreher-Einsatz	115
Pistolen-Gasanzünder	312	Säge-		drehersatz	62-65
Plastikhammer	106-107	blatt	161-163, 166-167	Schraub-	
Plombenzange	53	blatthalter	166	locher	21
Politur	258-261	Sägen	153-158, 160-162, 165	stock-/backen	302
PRESSOL Standardfettpresse	342	schrän kzange	155	zwinge	302-303
Presszange	54-55	setzer	155	Schreinerwinkel	134-135
Profiltiefenmaß	145	Salmiak-Lötstein	311	Schruppscheibe	334
Prüfpumpe	22	Sanitär		Schutz-	
PTFE-Gewindedichtband	23	Armaturen Rohr zange	31	brillen	319-321
PUK-		Sanitär-Kreuzschlüssel	24-25	glas für Schutzschild	322
Säge	161	S-Anschluss Montagewerkzeug	23	helm	318, 343
Sägeblatt	161	SAPHIR Schlagbohrer	191	schild	317-318
PVC		Saugheber	238-241	Schwammgummi-	
Flächenspachtelsatz	242	Schaffner-Kontrollzange	52	Reibebrett	250-251
Rohrschere	18	Schafs schere	270	Schweißer-	
		Schäkel	340	brille	321
R		Schaber	298-299	Gripzange	326
Rabitzzange	50	Schalungsbohrer	198	Schweißer-	
Radienschablone	147	Schaltschrankschlüssel	25	Kontrollspiegel	326
Radmutter schlüssel	102	Scharnierlochbohrer	199	schutzglas	322
Rangierwagenheber	120	Scheiben-		schutzschild	317-318
Ratsche	29, 114, 116-118	Bastlerbürste	325	Schweißkabel	314
Presszange	55	schneider	234	Schwerlastdübel	300
schlüssel	108-109	Schieblehre	143-145	Seilspannklemme	340
Rattenfalle	271	Schere	232, 276-281, 283	Seitenschneider	40-41, 44-46
Raubtierfalle	271	Scherenzange	45	Senker für Holzarbeit	199-200
Rebensäge	153	Schlackenhammer	326	Senklot	138
Reduzierringe	172	Schlag-		Setzeisen	301
Reibebrett	250-251	schlüssel	111	S-FIX Keile	347
Reifenprofiltiefenmaß	145	schnurroller	229	Sicherungs zange	48-49
Reifen-Ventil-Schraubendreher	102	schrauber	88	Signierkreide	228
Reißnadel	142-143			Signierschablonensatz	338
Revolverlochzange	50-51				



Silikon-Pistole	341	Trapez-Klingen	231	Z	
Simplexhaken	339	Trennscheibe	332-335	Zahnspachtel	245
Spachtel	241-245	Tür-		Zangen diverse	40-47
Spannungsprüfer	65-69	besen-/Bodendichtung	232	Zentrierbohrer	219
Spezial-		scharnier	340	Zentrumböhrer	199
Montagezange	48	stopper	270	Ziehklingen	160, 242-243
Ölwannenschlüssel	104			Zimmermanns	
Spiegel-		U		bleistift	136-137
halteklammern	255	Umfangbandmaß	149	bleistifthalter	136-137
Klebeband	232	Umsteckschraubendreher	62	winkel	136
Spiralbohrer	192-197, 211-217	Universal-		Zirkel	141-142
Spitzzirkel	141-142	Gewindefeile	125	Zubehör für Lochbohrer	225
Splintentreiber	294	Messer	230-231	Zündkerzen-	
Sprühkopf	254	Schaltschranckschlüssel	25	bürste	103
Stahl-		Ventilhalter	26	schlüssel	103
einziehband	71-72	Unterstellbock im Satz	120	Zündstein	312
lineal	140			Zurrurgurt	263
maßstab	140-141				
nägel	346	V			
Standhahn		Ventil			
Mutternschlüssel	26-27	einschleifer	106		
Mutternzange	27	feder Spannapparat	105		
Stangenscharnier	181	halter	26		
Stechbeitel	168	schraubendreher	102		
Steckgriff-Schraubendreher	87	stopfen	35		
Steckschlüssel	112-113	Verfugungsbrett	250		
einsatz	115, 117, 119	Vergaserschraubendreher	62		
satz	114, 116	Verschlusshülse	181		
Schraubendreher	89	Vierkantahle	152		
Steinbohrer	184-191, 204-210	Vollleder-Arbeitshandschuhe	343		
Stempel für Plombenzange	53	Vornschneider	41, 46		
Stichsäge	153	Vorschlaghammer	287		
blatt	350-354	Vorstechahle	152		
Stiele	107, 180, 264, 286-287				
Stiftschlüssel	90-92, 97	W		Impressum	
im Halter	93, 98	Wagenheber	120	Ausgabe:	2015/2016
satz	90, 92-95, 98-99	WALBY Maurerkelle	249	Herausgeber:	Dönges GmbH & Co. KG
Schraubendreher	96-97	Wandhaken	254		Jägerwald 11
Stirn-		Waschtisch Armaturen-Schlüssel	26		D-42897 Remscheid
lampe	262	Wasser-		Copyright:	Dönges GmbH & Co. KG
lochschlüssel	112	hahn-Fräsaparat	22	Redaktion:	Wolfgang Schulz
Stockschraubenschlüssel	26	pumpenzange	37-38		Wilfried Funk
Stopfenschlüssel	24	schieber	228	Gestaltung:	Birgit Zimmermann
Streichmaß	137, 167	waage	138-139		Roland Hontheim
Streifenhobelmesser	169	Weichlötmasse	310	Fotos:	Fotolia, Industrie,
Stromprüfer	68	Wendelrührer	226		Birgit Zimmermann
Stufenschlüssel	28-29	Werkstatt-		Alle Fotos sind urheberrechtlich	
Syphonzange	32	feile	173-179	geschützt.	
		Mikrometer	149	Sortiment freibleibend, keine Haftung	
T		Werkzeug-		bei Irrtümern und Druckfehlern.	
Taschenfederwaage	270	halter	127-128	Produktänderungen bleiben uns vor-	
Tauchsieder	272	koffer	120-121, 267	behalten. Vervielfältigung jeglicher	
Telefon-		satz	297	Art, auch auszugsweise, darf nur mit	
und Kabelschere	281	Wetzstahl	159	schriftlicher Genehmigung erfolgen.	
Telefonzange	40-41, 44-45	Windeisen	128-129		
TELESKOP Mutternschlüssel	26	Winkelschraubendreher	69, 90-99		
Teppichmesser	230-231	Wirbel	339		
T-Griff Stiftschlüsseldreher	96-97	Wolfsmaul-Schmiedezange	344		
Topf-Bastlerbürste	325				
Topfbürste	324				
TORPEDO Wasserwaage	138				
TORX Schraubendreher	59, 97-99				

A		Butcher's		Copper	
Abrasive flap wheel	330	saw	157	tube bending pliers	27
Adapter set	81	saw blade	157	tube cutter	18-20
Adhesive tape	232	steel	159	Countersink drill	199-200
Adjustable		Button gauge	145	Coupler	342
connector	254			Crimp pliers	54-55
face spanner	112	C		Crimping pliers	54-55
wrench	39	Cabinet key	25	Curved bearing scraper	299
Allen		Cable		Cut-off wheel	332-335
key	90-92, 97	knife	73-78	Cutting disc	332-335
key in holder	93, 98	lugs assortment	55		
key screwdriver	96-97	scissor	281		
key set	90, 92-95, 98-99	tie	70		
Aluminium		Caliper	143-145	D	
lay on jaws	302	Cans	121	Desoldering pump	304
rule	140	Carburettor screwdriver	62	Diagonal cutter	45
spirit level	138-139	Carlight tester	68	Diamond cutting disc	332-333
Anchor	300	Carpenter's		Die stock	127
Animal trap	271	pencil	136-137	Dividers	141-142
Anti freeze tester	105	pencil holder	136-137	Door	
Arbour for hole saw	355	pincer	50	bolt	343
Arch punch	290	square	134-136	buffer	270
Auger bit	218	Carpet knife	230-231	Dovetail saw	156
Autodarkening welding helmet	318	Case opener	168	Dowel extractor	157
Automatic knife	230	Caulking gun	341	Drain	
AUTOSOL product	258-261	Center		adjustment pliers	32
Axe	180	drill	219	plug wrench	104
Axel stand set	120	punch	291-293	Draught excluder	232
		Centre bit	199	Draw-in band /-spiral	71-72
B		Chain			
Back saw	154	pipe wrench	33	E	
Baghdad saw	153	saw file	173	Earth clamp	315
Ball		wrench	104	Eaves gutter bending pliers	49, 273
pane hammer	289	Chalk	229	Elastic pad	267
tap wrench	129	Chalk line	229	Electrician's	
Band saw	167	Charging clamp	314	knife	73-78
Bar cutter „VITTE“	283	Chisel	295-298	screwdriver	58, 60-61, 64
Basin plug	35	Chisel-Punch tool set	297	Electrode holder	313
Battery charging clamp	314	Circle glass cutter	234	Electronic pliers	42-43, 46-47
Bending pliers	27, 49, 273	Circlip pliers	48-49	Empty tool box	120-121, 267
Binding clip	181	Circular		End brush	325
Bit		saw blade	170-172	Extension for tap	126
screw insert	81-87	wire brush	324	Eyelet	51
screw insert set	86-87	Circumference rule	149	pliers	51
screwdriver handle	87	Coach hinges	340		
Blacksmith's tong	344-345	Coachwork		F	
Blades for knives	231	file	107	F-Clamp	302-303
Blitz wrench	32	file holder	107	Feeler	
Block cutting knife	169	Combination pliers	40-41, 44-45	gauge	146-147
Bolt	343	Combined spanner	108-110	gauge tape	148
Bottle jack	120	Come along clamp	340	Fibre disc	331
Bottom carrier	269	Compass saw	153, 157	File	173-179
Bow saw	158	Compressor	121	brush	175
Bracket	269	Concrete mixer	226	Fire fighting equipment	4
Brake spring pliers	105	Contact file	175	FIT pliers	45
Branch saw	154	Control mirror	326	Fitting brush	24
Brazing powder	311	Coping		Flange square	134
Breast drill	203	saw blade	162-163	Flap	
Broom	264	saw clamp	163	disc	329
handle	264	saw frame	162	wheel	330
Butcher's		Copper		Flat	
hook	160	hammer	285	square scraper	298
				steel band	71-72

Flat wood working drill	218	Hatchet	180	Magnet spanner	113
Flint	312	Head lamp	262	Magnetic	
Float	250-251	Heater Airing key	25-26	holder	88
Foam, rubber wiper	228	Helmet	343	pick-up tool	80
Forstner drill	218	Hemp rope	24	Marking	
Four-way wrench	24-25, 102	Hexagonal screwdriver	90-92, 97	crayon	228
Frame wood drill	198	High pressure hose	342	gauge	137, 167
Fretwork		Hinge	181	Masonry drill	184-189, 191, 204-210
blade	162-163	hole cutter	199	Mason's string	229
drill	163	Holder for feeler gauge tape	148	Measuring tape	132-133
frame	162	Hole		Meat hook	160
table	163	saw	225, 355	Mechanic's square	134
tool sets	164-165	saw accessories	225, 355	Metal	
Front cutter	41	Hollow punch	291	anchor	300
Fuel jerrycans	121	Hook	347	cutting shear	276-279
FUGI for smoothing silicon	227	blade	231	polish	258-261
G		spanner	111	saw blades	161, 166-167
Gap chisel	298	Hose		Micrometer	149
Garnishing needle	233	clamp	265-266	MINI Compressor	121
Gas		clip screwdriver	88	Mirror clip set	255
lighter	312	cutting shear	30	Mitre	
pipe wrench	24	Hydraulic coupler	342	box	156-157
Gasket cutter	234	Hydro sponge float	250-251	saw	158
Gimlet	200	I		Mortise bits	198
Glass		ILSE quick wrench	31	Mountings- setting	
breaking pliers	241	Immersion heater	272	up-loam board	23
cutter	234-237	Impact screwdriver	88	Mouse trap	271
drill	201	Inside		Multimeter	69
scraper	238	divider	142	N	
Glättfix	227	pliers	30	Nail	346
Glove	343	Insulating material knife	230	puller	181
Glue		JAPAN Wall scraper set	241	set	292-293
gun	308	Jet gauge	149	setter	301
stick	308	Jeweller saw frame	162	Nest of saw	155
Grease gun	342	Jeweller's snip	280	Non sparking tool	4
Grinding		Jig saw blades	350-354	Nozzle reamer	201
block	342	JOKARI Knife	73-76	Number punch set	336-337
disc	331, 334	JUMBO regulator	316	Nylon	
stone	169	K		Draw-in band	71-72
Grip pliers	326-328	Key		hammer	106
Grout rake	226	ring	268	protection goggle	319-321
Gypsum		tag	268	O	
cup	229	Knife	73-78, 230-231	Offset screwdriver	69
hatchet	288	L		Oil	
H		Lashing system	263	drain plug wrench	104
Hacking knife	77	Lead seal pliers	53	filter key	103-104
Hacksaw frame	160-161, 165	Letter punch set	336-337	Oilfilter strap key	103
Hammer		Lever		Open end spanner	108-109
chisel	187-188, 190, 209-211	cutting nipper	46	Outside divider	142
drill	186-189, 191, 206-210	side cutting nipper	46	P	
Hand		Long nose pliers	40-41, 44-45	Packing needle	233
cleaning paste	261	M		Paint mixer	226
drill	203	Machine		Parallel pin punch	294
protector for chisel	298	mortise bits	198	Piano Hinge	181
saw	153-158, 160-162, 165	saw blade	167	Pick axe	264
shower	253	Machinist's files	173-179	Piercer	152
tap	124-125, 129	Machinist's hammer	284-285	Pilot drill	355
vices	282-283			Pipe cleaner	35-36
wire brush	323				
Handle	107, 180, 264, 286-287				

P		
Pipe		
crimper	31	
reamer	20-21	
wrenches	31-35, 37	
Piston		
ring pliers	104	
ring tightening strap	104	
Plastic		
float	250-251	
hammer	106-107	
Pliers, diverse	40-47	
Plugging chisel	168	
Plumb bob	138	
Pocket balance	270	
Polishing material	258-261	
Pot brush	324-325	
Precision caliper	143-145	
PRESSOL Grease gun	342	
Pressure		
regulator	315-316	
test pump	22	
Protecting		
goggle	319-321	
helmet	343	
shield	317	
Protractor	137	
Pruning saw	153-154	
PTFE screw thread band	23	
PUK		
saw	161	
saw blade	161	
Punch	290-291	
Punches for lead seal pliers	53	
Punching tool	21	
PVC		
cutting shear	18	
Scraper	242	
Tube cutting shear	18	
Q		
Quick spanner wrench	31-32, 38	
R		
Radius gauge set	147	
Rail	269	
Rasp	174, 178-179	
Rat trap	271	
Ratchet	29, 114, 116-118	
crimping pliers	55	
spanner	108-109	
Reamer	20-21	
Redressing tool	335	
Reduction ring for saw blades	172	
Reinforcement steel		
cutting shear	283	
Resistance for		
Soldering iron	305, 307	
Reversible screwdriver	62	
Revolving punch pliers	50-51	
Rim wrench	102	
Ring spanner	110-111	
Rivetting pliers	39	
Roofing hammer	288	
Round		
die	126	
wire brush	325	
Rubber		
cup	229	
foam float	250-251	
mallet	289	
pad	267	
tile joint	224	
RUBIN Hammer drill	191	
Rule	140-141	
S		
Safety glasses	319-321	
Sal ammoniac stone	311	
Sanitary		
fitting wrench	31	
key	26	
rim wrench	24-25	
wrench	26, 31-32	
SAPHIR Hammer drill	191	
Saw	153-158, 160-162, 165	
blade	161-163, 166-167	
blade holder	166	
set	155	
set pliers	155	
Scissor	232, 280-281, 283	
Scraper	160, 241-245, 298-299	
steel	160	
with teeth	245	
Screw		
clamp	302-303	
extractor	201, 219	
in tool	23	
pitch gauge	147	
thread band	23	
Screwdriver	58-65, 69	
set	62-65	
socket	115	
S-FIX wedge	347	
Shakle	340	
Sheep shear	270	
Sheet shear	276-279	
Shell drill	200	
Shower hose	252	
Side cutter	40-41, 44-46	
Silicone gun	341	
Single		
flute cutter	202	
spanner	109	
Sink cleaner	35	
Slate ripper	273	
Sledge hammer	286-287	
Sliding bevel	135	
Slip on claw	27	
Slogging spanner	111	
Snap hook	339	
Socket	115, 117, 119	
nut driver	89	
set	114, 116	
Solder rod	309	
Soldering		
copper	310	
grease	310	
iron/-gun	304-307, 310	
paste	310	
point for iron	307	
wire	308-309	
Spare		
blade JOKARI	74	
cutting wheel	19-20, 223, 235	
head for Glass cutter	237	
head for plastic hammer	107	
Spark		
plug brush	103	
plug wrench	103	
Spirit level	138-139	
Spout	121	
Square	134	
Steel		
cutting shear	283	
hooks	347	
nails	346	
punch set	336-337	
rule	140-141	
scraper	142-143	
Stencil plate set	338	
Stepped key	28-29	
Stock & die set	124	
Stop plug	23	
Strap key	103	
Suction lifter	238-241	
Swivel	339	
T		
Tap		
holder	127-128	
wrench	128-129	
Telephone		
& Cable scissor	281	
pliers	40-41, 44-45	
Telescopic wrench for water tap	26	
T-Handle socket	113	
nut driver	89	
Thread		
cutting set	129	
gauge	147	
repairing file	125	
Three square		
flat ground scraper	299	
hollow ground scraper	299	
Ticket punch plier	52	
Tile		
cross and wedge	224	
cutter	224	
cutting machine	222	
file	226	
hole cutter	223	
sponge	227	
Tiler's pliers	49, 273	
Tiler's trowel	248	



Tinmen's shear	276-279	Wiper	228
Tinner's pliers	344	Wire	
Tommy bar	102	bending drill	80-81
Tool		brush	323-325
box	120-121, 267	rope clip	340
set	297	stretcher	340
TORPEDO spirit level	138	stripper	41, 45
Torque wrench	103	Wood	
TORX screwdriver	59, 97-99	axe	180
Tower pincer	50	chisel	168
TRAPEZ blade	231	working drill	197, 217
Trolley jack	120	Wooden	
Trowel	246-249	axe handle	180
Tube		hammer	289
bending pliers	27	handle	107, 180, 264, 286-287
cutter	18-20	Working glove	343
works	17	Wrecking bar	168
Tubular box spanner	112-113	Wrench for	
Tweezer	78-79	stock screw	26
Twist drills	192-197, 211-217	water tap	26-27
Tyre			
profile depth gauge	145		
valve screwdriver	102		

U

U-rail	269
--------	-----

V

Valve	
grinder	106
holder	26
lifter	105
seat reaming device	22
Veneer cutter	155
Vice	302
Voltage tester	65-69
Volute spring	270

W

WALBY Trowel	249
Wall hook	254
Warding file set	173
Washbasin wrench	26
Watchmaker's screwdriver	79-80
Water	
fix	254
pump nut pliers	27
pump pliers	37-38
Webbing load	263
Wedge	347
Welding	
cable	314
cable connector	314
glass	322
goggle	321
grip pliers	326
hammer	326
helmet	317-318
mask	317
mirror	326
shield	317-318

Impression:

Issue: 2015/2016

Issued by: Dönges GmbH & Co. KG
Jägerwald 11
D-42897 Remscheid

Copyright: Dönges GmbH & Co. KG

Editorial: Wolfgang Schulz
Wilfried Funk

Graphics: Birgit Zimmermann
Roland Hontheim

Photos: Fotolia, Industry,
Birgit Zimmermann

All photos protected by copyright. Product range subject to change, no liability accepted for mistakes or printing errors. Right reserved to make product changes. Copying of any kind, even of extracts, requires written permission.

Liefer-/Auftragsbedingungen

I. Maßgebende Bedingungen

1. Die Rechtsbeziehungen für alle Lieferungen und Leistungen durch die Dönges GmbH & Co. KG (Lieferant) an Unternehmen (Besteller) richten sich nach diesen Bedingungen und etwaigen sonstigen Vereinbarungen.

2. Änderungen und Ergänzungen bedürfen der Schriftform. Andere Allgemeine Geschäftsbedingungen gelten auch dann nicht, wenn ihnen im Einzelfall nicht ausdrücklich widersprochen wurde. Diese Liefer- und Auftragsbedingungen gelten auch für alle künftigen Lieferungen und Leistungen durch den Lieferanten an den Besteller, selbst wenn sie nicht nochmals ausdrücklich vereinbart werden. Sie gelten nur gegenüber Unternehmern i.S.v. § 14 BGB.

II. Bestellung

1. Die Angebote des Lieferanten sind freibleibend und unverbindlich. Beschaffensvereinbarungen, Beschaffens- und Haltbarkeitsgarantien bedürfen der Schriftform.

2. Soweit nichts anderes bestimmt ist, hat die Lieferung unversichert auf Kosten und Gefahren des Bestellers an die vom Besteller genannte oder zu nennende Empfangs- oder Verwendungsstelle zu erfolgen. Die Gefahr geht mit der Übergabe an die zur Ausführung des Transports bestimmten Person auf den Besteller über. Dies gilt auch für den Fall einer Bringschuld des Lieferanten.

3. Im Fall der Bring- und Schickschuld ist der Lieferant berechtigt, Transportmittel und Transportweg zu bestimmen. Abweichende Vereinbarungen bedürfen der Schriftform.

III. Preise und Zahlung

1. Alle vom Lieferanten genannten Preise verstehen sich zzgl. gesetzlicher Umsatzsteuer (soweit diese nicht ohnehin bereits ausgewiesen ist). Die Kosten für Verpackung, Versand und Versicherungen sind in den Preisen nicht enthalten und vom Besteller separat zu entrichten, es sei denn, der Lieferant bestätigt deren Übernahme ausdrücklich schriftlich.

2. Die Zahlung erfolgt, soweit nicht ausdrücklich abweichendes vereinbart ist, innerhalb von 10 Kalendertagen ab Rechnungsdatum mit 2% Skonto, innerhalb von 30 Tagen ab Rechnungseingang netto. Dies gilt auch bei Annahme verfrühter Lieferungen. Der Lieferant ist jederzeit berechtigt, ohne Angabe von Gründen eine Lieferung Zug-um-Zug zu verlangen.

3. Die Zahlung erfolgt, soweit nicht etwas anderes vereinbart worden ist, durch Überweisung oder Scheck. Schecks werden nur erfüllungshalber entgegengenommen.

4. Bei mangelhafter Lieferung ist der Besteller berechtigt, die Zahlung wertanteilig bis zur ordnungsgemäßen Erfüllung zurückzuhalten.

5. Der Lieferant ist ohne vorherige schriftliche Zustimmung des Bestellers berechtigt, seine Forderungen gegen diesen abzutreten oder durch Dritte einziehen zu lassen.

6. Der Besteller ist zur Aufrechnung nur hinsichtlich solcher Gegenansprüche berechtigt, die rechtskräftig festgestellt worden sind, eine entscheidungsreife Gegenforderung betreffen, vom Lieferanten unbestritten sind oder bezüglich derer der Lieferant ausdrücklich schriftlich der Aufrechnung zugestimmt hat. Ein Zurückbehaltungsrecht des Bestellers besteht ebenfalls nur in den in Satz 1 genannten Fällen.

7. Zurückbehaltungsrechte und Aufrechnungsbefugnis des Lieferanten unterliegen keinen Beschränkungen. Es gelten insoweit die gesetzlichen Regelungen.

IV. Geheimhaltung

1. Die Vertragspartner verpflichten sich, alle nicht offenkundigen kaufmännischen und technischen Einzelheiten, die ihnen durch die Geschäftsbeziehungen bekannt werden, als Geschäftsgeheimnis zu behandeln.

Zeichnungen, Modelle, Schablonen, Muster und ähnliche Gegenstände dürfen unbefugten Dritten nicht überlassen oder sonst zugänglich gemacht werden. Die Vervielfältigung solcher Gegenstände ist nur im Rahmen der betrieblichen Erfordernisse und der urheberrechtlichen Bestimmungen zulässig. Diese Verpflichtungen haben über die Beendigung der Lieferbeziehung hinaus Bestand. Unterlieferanten werden vom Lieferanten entsprechend verpflichtet.

2. Die Vertragspartner dürfen nur mit vorheriger schriftlicher Zustimmung mit ihrer Geschäftsverbindung werben.

V. Liefertermine und -fristen, Liefermodalitäten

1. Vereinbarte Termine und Fristen sind nur verbindlich, wenn diese durch den Lieferanten schriftlich und ausdrücklich als verbindlich bestätigt werden.

2. Ein bestätigter Liefertermin steht unter dem Vorbehalt der richtigen, vollständigen und rechtzeitigen Selbstbelieferung. Bei endgültiger Nichtbelieferung des Lieferanten durch seinen Vertragspartner steht beiden Parteien das Recht zu, vom Vertrag insoweit zurückzutreten. Die Haftung (Abschnitt XI) des Lieferanten entfällt in den Fällen der Sätze 1 und 2 nur, wenn sich die mangelhafte, verspätete oder gänzlich ausgebliebene Selbstbelieferung nicht als Folge einer vom Lieferanten zu vertretenden Pflichtverletzung darstellt.

2. Maßgebend für die Einhaltung des Liefertermins oder der Lieferfrist ist mangels anderweitiger schriftlicher Vereinbarung die rechtzeitige Bereitstellung der Ware zum Versand im Falle der Schickschuld, zur Lieferung im Falle der Bringschuld und zur Abholung im Falle der Holschuld und die entsprechende Mitteilung an den Besteller.

3. Vorzeitig angelieferte Ware muss vom Besteller angenommen werden. Ein Vorbehalt der Rücksendung auf Kosten des Lieferanten ist nicht vereinbart und bedarf einer ausdrücklichen schriftlichen Vereinbarung zwischen den Parteien. Lagert der Besteller die Ware bis zum vereinbarten Liefertermin ein, trägt er die hierfür anfallenden Kosten. Die Einlagerung erfolgt auf seine Gefahr.

4. Teillieferungen sind zulässig, soweit sich für den Besteller hieraus keine unzumutbaren Nachteile ergeben.

VI. Lieferverzug, Schadenspauschalierung

1. Im Fall des Lieferverzugs ist der Anspruch des Bestellers im Fall einfacher Fahrlässigkeit auf den Ersatz des typischerweise vorhersehbaren Schadens begrenzt. Im Übrigen gilt für die Haftung auf Verzugsschäden Abschnitt XI.

2. Befindet sich der Besteller in Annahmeverzug und hat der Lieferant dem Besteller eine angemessene Frist zur Annahme der Ware gesetzt, die ergebnislos verstrichen ist, oder hat der Besteller die Annahme ernsthaft und endgültig verweigert, so ist der Lieferant berechtigt, vom geschlossenen Vertrag zurück zu treten und Schadensersatz zu verlangen. Der Schadensersatzanspruch des Bestellers beläuft sich auf pauschalierte 10% des Nettopreises für die nicht abgenommene Ware, es sei denn, der Besteller hat seine Pflichtverletzung nicht zu vertreten. Der Besteller ist berechtigt, dem Lieferanten nachzuweisen, dass ein Schaden geringeren Umfangs als mit der Pauschale vereinbart oder gar kein Schaden entstanden ist. In diesem Fall ermäßigt sich der Schadensersatzanspruch entsprechend oder gerät insgesamt in Wegfall. Das Recht des Lieferanten, den Schaden konkret zu berechnen und aufgrund konkreter Berechnung auch einen über der Pauschale liegenden Schadensersatzanspruch geltend zu machen, bleibt unberührt.

VII. Höhere Gewalt

Höhere Gewalt, Arbeitskämpfe, Unruhen, behördliche Maßnahmen und sonstige unvorhersehbare, unabwehrbare und schwerwiegende Ereignisse befreien die Vertragspartner für die Dauer der Störung und im Umfang ihrer Wirkung von den Leistungspflichten. Dies gilt auch, wenn diese Ereignisse zu einem Zeitpunkt eintreten, in dem sich der betroffene Vertragspartner in Verzug befindet. Die Vertragspartner sind verpflichtet, im Rahmen des Zumutbaren unverzüglich die erforderlichen Informationen zu geben und ihre Verpflichtungen den veränderten Verhältnissen nach Treu und Glauben anzupassen.

VIII. Qualität und Dokumentation

Änderungen des Liefergegenstandes bedürfen nicht der vorherigen schriftlichen Zustimmung des Bestellers, soweit sie vom Besteller gewünscht oder dem Stand der Technik entsprechend sachdienlich sind.

IX. Mängel, Mängelanzeige und Anzeigefristen

1. Zwischen den Parteien gilt § 377 HGB uneingeschränkt mit den sich hieraus ergebenden Pflichten für die Eingangskontrolle des Bestellers. Der Lieferant übernimmt durch seine Wareenausgangskontrolle nicht die Wareingangskontrolle des Bestellers. Er übernimmt auch im Übrigen keine dem Besteller gem. § 377 HGB obliegenden Verpflichtungen.

2. Versandbedingte Mängel und Unstimmigkeiten in den Begletpapieren sowie alle übrigen Mängel wird der Besteller, soweit sie offen zutage liegen, innerhalb von drei Werktagen ab Ablieferung rügen. Die Rügefrist für bei einer ordnungsgemäßen Untersuchung zutage tretende Mängel beträgt sechs Werktagen ab Ablieferung, für verdeckte Mängel beträgt sie sechs Werktagen ab Entdeckung.

3. Die vom Lieferanten gelieferte Ware ist frei von Sachmängeln, wenn ihre Kenndaten innerhalb der allgemein anerkannten und der fertigungsbedingten Toleranzen liegen.

X. Mängelrechte

1. Sollte sich die Ware als mangelhaft erweisen, kann der Besteller, wenn die jeweiligen gesetzlichen Voraussetzungen vorliegen und soweit nicht etwas anderes vereinbart ist, Folgendes verlangen (Abschnitt IX bleibt unberührt):

a) Die Wahl zwischen Nachbesserung und Nachlieferung trifft der Lieferant nach billigem Ermessen. Nachbesserung und Nachlieferung erfolgen stets nur auf Kulanz und ohne Anerkennung einer Rechtspflicht.

b) Soweit der Besteller das Wahlrecht ausübt, beschränkt sich sein Nacherfüllungsanspruch auf die gewählte Variante der Nacherfüllung, bis sich diese Variante als undurchführbar erweist oder der Lieferant die Durchführung der Nacherfüllung nach der gewählten Variante verweigert. Das Recht des Käufers, wegen Fehlschlagens der Nacherfüllung unter den gesetzlichen Voraussetzungen Minderung, Rücktritt oder Schadensersatz geltend zu machen, bleibt unberührt.

c) Bei einer über die Lieferung mangelhafter Ware hinausgehenden schuldhaften Pflichtverletzung (z.B. bei einer Aufklärungs-, Beratungs- oder Untersuchungspflicht) kann der Besteller Ersatz des daraus resultierenden Mangelfolgeschadens sowie des vom Besteller seinem Kunden gemäß Gesetz erstatteten Mangelfolgeschadens nach Maßgabe von Abschnitt XI verlangen. Mangelfolgeschaden ist der Schaden, den der Besteller durch die Lieferung mangelhafter Ware an anderen Rechtsgütern als an der Ware selbst erlitten hat.

d) Soweit der Besteller aufgrund eines Mangels Schadensersatzansprüche geltend macht, finden ergänzend zu diesem Abschnitt die Regelungen in Abschnitt XI Anwendung.

2. Die Regelungen über den Rückgriff des Unternehmers gemäß § 478 BGB bleiben von der Regelung gemäß Ziffer 1 unberührt.

3. Dem Lieferanten sind die von ihm zu ersetzenden Teile auf Verlangen und auf seine Kosten vom Besteller unverzüglich zur Verfügung zu stellen.

4. Mängelansprüche entstehen nicht, wenn der Fehler auf Verletzung von Bedienungs-, Wartungs- und Einbauvorschriften, ungeeignete oder unsachgemäße Verwendung, fehlerhafte oder nachlässige Behandlung und natürlichen Verschleiß sowie vom Besteller oder Dritten vorgenommene unsachgemäße Eingriffe in den Liefergegenstand zurückzuführen ist.

5. Die Mängelrechte des Bestellers verjähren

- in vier Jahren, wenn der Kaufgegenstand in einem Bauwerk oder in einer Sache besteht, die entsprechend ihrer üblichen Verwendungsweise für ein Bauwerk verwendet worden ist und dessen Mangelhaftigkeit verursacht hat,

- im Übrigen mit Ablauf von 12 Monaten.

6. Ziffer 5 lässt die Verjährung von Rückgriffsansprüchen gemäß § 479 BGB unberührt. Im Übrigen gelten für die Verjährung, insbesondere für den Beginn der Verjährung, die gesetzlichen Vorschriften. Die Regelung in Abschnitt X Ziffer 1a Satz 2 bleibt unberührt.

7. Bei mangelhaften Lieferungen bleiben Ansprüche des Bestellers aus Produkthaftungsgesetz, unerlaubter Handlung und Geschäftsführung ohne Auftrag von diesem Abschnitt X unberührt. Beschaffens- und Haltbarkeitsgarantien müssen ausdrücklich schriftlich im Einzelnen als solche bezeichnet werden.

XI. Haftung

1. Eine Verpflichtung des Lieferanten zum Schadensersatz setzt grundsätzlich ein Verschulden des Lieferanten oder ein ihm zuzurechnendes Verschulden hinsichtlich des von ihm verursachten Schadens voraus. Die Verjährungsregel des § 438 BGB findet auch für den Ersatz von Schäden, die infolge des Mangels an einem sonstigen gegenüber jedermann geschützten Rechtsgut (z.B. Eigentum, Körper etc.) des Bestellers oder eines Dritten dem Besteller entstehen, Anwendung, soweit § 438 BGB grundsätzlich auf den Vertrag Anwendung findet. Abschnitt X.5 und X.6 Satz 1 und 2 gelten insoweit entsprechend. Zur Haftung dem Grunde und der Höhe nach sind die nachfolgenden Ziffern dieses Abschnitts zu beachten.

2. Der Lieferant haftet für schuldhaft verursachte Personenschäden unbeschränkt. Im Übrigen haftet er auf Schadensersatz nur bei vorsätzlichen oder grob fahrlässigen Pflichtverletzungen seiner selbst, seiner gesetzlichen Vertreter sowie der Personen, derer er sich zur Erfüllung seiner Verbindlichkeiten bedient. Bei leicht fahrlässiger Pflichtverletzung der vorgenannten Personen haftet der Lieferant auf Schadensersatz nur, wenn die Pflichtverletzung Ausdruck einer Verletzung wesentlicher Vertragspflichten ist. Eine wesentliche Vertragspflicht im vorgenannten Sinn ist eine solche, deren Erfüllung die ordnungsgemäße Durchführung des Vertrags überhaupt erst ermöglicht und auf deren Einhaltung der Vertragspartner regelmäßig vertraut und vertrauen darf. Im Fall leichter Fahrlässigkeit ist die Haftung der Höhe nach auf den vertragstypischen Schaden beschränkt.

3. Wird der Besteller aufgrund verschuldensunabhängiger Haftung nach Dritten gegenüber nicht abdingbarem Recht in Anspruch genommen, tritt der Lieferant gegenüber dem Besteller nur insoweit ein, wie er gegenüber dem Besteller nach den gesetzlichen Regelungen unter Berücksichtigung dieser Verkaufsbedingungen einzustehen hat.

Für den Schadensausgleich zwischen Besteller und Lieferant finden die Grundsätze des § 254 BGB entsprechende Anwendung. Dies gilt auch für den Fall einer direkten Inanspruchnahme des Lieferanten.

4. Die Ersatzpflicht ist ausgeschlossen, soweit der Besteller seinerseits die Haftung gegenüber seinem Abnehmer wirksam beschränkt hat. Dabei wird der Besteller bemüht sein, Haftungsbeschränkungen in rechtlich zulässigem Umfang auch zugunsten des Lieferanten zu vereinbaren.

5. Ansprüche des Bestellers sind soweit ausgeschlossen, wie der Schaden zurückzuführen ist auf dem Besteller zuzurechnende Verletzungen von Bedienungs-, Wartungs- und Einbauvorschriften, ungeeignete oder unsachgemäße Verwendung, fehlerhafte oder nachlässige Behandlung, natürlichen Verschleiß oder fehlerhafte Reparatur.

6. Der Besteller wird den Lieferanten, falls er diesen nach den vorstehenden Regelungen in Anspruch nehmen will, unverzüglich und umfassend informieren und konsultieren. Er hat dem Lieferanten Gelegenheit zur Untersuchung des Schadenfalls zu geben. Über die zu ergreifenden Maßnahmen, insbesondere bei Vergleichsverhandlungen, werden sich die Vertragspartner abstimmen.

7. Die Haftungsbeschränkungen und -ausschlüsse gemäß Ziffer 1 bis 6 dieses Abschnitts gelten in gleichem Umfang zugunsten der gesetzlichen Vertreter, der leitenden und nicht leitenden Angestellten und sonstigen Erfüllungsgehilfen sowie der Subunternehmer des Lieferanten.

XII. Schutzrechte

1. Der Lieferant haftet für Ansprüche, die sich bei vertragsgemäßer Verwendung der Liefergegenstände aus der Verletzung von Schutzrechten und Schutzrechtsanmeldungen (Schutzrechte) ergeben, nur im Rahmen der gesetzlichen Bestimmungen unter Berücksichtigung der Haftungsregelungen in diesen Verkaufsbedingungen (Abschnitt XI).

2. Er stellt den Besteller und seine Abnehmer insbesondere nicht von allen Ansprüchen aus der Benutzung solcher Schutzrechte frei, soweit er nicht gemäß Ziffer 1 eintrittspflichtig ist.

3. Der Lieferant haftet insbesondere nicht, soweit er die Liefergegenstände nach vom Besteller übergebenen Zeichnungen, Modellen oder diesen gleichkommenden sonstigen Beschreibungen oder Angaben des Bestellers hergestellt hat und nicht weiß oder im Zusammenhang mit den von ihm entwickelten Erzeugnissen nicht wissen muss, dass dadurch Schutzrechte verletzt werden.

4. Die Vertragspartner verpflichten sich, sich unverzüglich von bekannt werdenden Verletzungsrisiken und angeblichen Verletzungsfällen zu unterrichten und sich Gelegenheit zu geben, entsprechenden Ansprüchen einvernehmlich entgegenzuwirken.

5. Der Besteller wird auf Anfrage des Lieferanten die Benutzung von veröffentlichten und unveröffentlichten eigenen und von lizenzierten Schutzrechten und Schutzrechtsanmeldungen an dem Liefergegenstand mitteilen.

6. Soweit der Lieferant gemäß Ziffern 1 bis 5 eintrittspflichtig ist und soweit nicht ausdrücklich schriftlich anders vereinbart, haftet der Lieferant nur bei der Verletzung in Deutschland geschützter Schutzrechte.

XIII. Vertragsstrafen, pauschalierter Schadensersatz

Unabhängig von der Schadensart (Mängelansprüche, Schadensersatz statt oder neben der Leistung, Produkthaftung, etc) muss der Besteller den ihm entstandenen Schaden konkret berechnen. Eine Pauschalierung des Schadensersatzanspruches scheidet aus, Vertragsstrafen sind zwischen den Parteien nicht vereinbart. Die Vereinbarung von Schadenspauschalen und Vertragsstrafen kann nur individualvertraglich erfolgen und bedarf der Schriftform.

XIV. Eigentumsvorbehalt

1. Der Lieferant liefert an Besteller nur auf der Basis des nachstehend näher geschilderten Eigentumsvorbehaltes. Dies gilt auch für alle zukünftigen Lieferungen, auch wenn sich der Lieferant nicht stets ausdrücklich hierauf beruft.

2. Bis zur vollständigen Bezahlung aller Ansprüche aus der Geschäftsverbindung einschließlich entstandener Nebenkosten (Diskontospesen, Refinanzierungs- oder Umkehrwechsel-Zinsen etc) bleiben die Liefergegenstände Eigentum des Lieferanten, auch wenn sie zum Weiterverkauf bestellt worden sind oder dem Besteller ein Zahlungsziel gewährt worden ist (Vorbehaltsware). Die Vorbehaltsware darf nur im ordnungsgemäßen Geschäftsverkehr weitergegeben werden.

3. Durch Verarbeitung dieser Waren erwirbt der Besteller kein Eigentum an den ganz oder teilweise hergestellten Sachen; die Verarbeitung erfolgt unentgeltlich ausschließlich für den Lieferanten. Sollte dennoch der Eigentumsvorbehalt durch irgendwelche Umstände erlöschen, so sind sich Lieferant und Besteller schon jetzt darüber einig, dass das Eigentum an den Sachen mit der Verarbeitung auf den Lieferanten übergeht, der die Übereignung annimmt. Der Besteller bleibt deren unentgeltlicher Verwahrer.

Bei der Verarbeitung mit noch in Fremdeigentum stehenden Waren erwirbt der Lieferant Miteigentum an den neuen Sachen. Der Umfang dieses Miteigentums ergibt sich aus dem Verhältnis des Rechnungswertes der von uns gelieferten Ware zum Rechnungswert der übrigen Ware.

4. Der Besteller tritt hiermit die Forderung aus einem Vertrag über die Weitergabe der Vorbehaltsware (in der Regel aber nicht ausschließlich den Kaufpreisanspruch) einschließlich Umsatzsteuer an den Lieferanten ab, und zwar auch insoweit, als die Ware verarbeitet ist. Der Lieferant nimmt hiermit die Abtretung an. Erhält der Besteller eine solche Forderung durch Zahlung auf sein Bankkonto beglichen, tritt er hiermit seine Forderung gegen die Bank an den Lieferanten ab, der hiermit die Abtretung annimmt.

Enthält das Verarbeitungsprodukt neben der Vorbehaltsware des Verkäufers nur solche Gegenstände, die entweder dem Besteller gehören oder aber nur unter dem so genannten einfachen Eigentumsvorbehalt geliefert worden sind, so tritt der Besteller die gesamte Kaufpreisforderung an den Lieferanten ab. Im anderen Falle, d. h. beim Zusammentreffen der Voraussetzungen an mehrere Lieferanten, steht dem Lieferanten ein Bruchteil der Forderung zu, entsprechend dem Verhältnis des Rechnungswertes ihrer Vorbehaltsware zum Rechnungswert der anderen verarbeiteten Gegenstände.

5. Der Lieferant verpflichtet sich, auf Verlangen des Bestellers die ihr nach den vorbestehenden Bedingungen zustehenden Sicherheiten nach Wahl des Lieferanten freizugeben, soweit der realisierbare Wert der Sicherheiten die zu sichernden Forderungen um mehr als 10% übersteigt.

6. Der Besteller verpflichtet sich, solange das Eigentum noch nicht auf ihn übergegangen ist, die bestellte Ware pfleglich zu behandeln. Insbesondere ist er verpflichtet, diese auf eigene Kosten gegen Diebstahl-, Feuer-, Bruch- und Wasserschäden ausreichend zum Neuwert zu versichern. Der Lieferant ist berechtigt, diese Versicherung auf Kosten des Bestellers vorzunehmen. Müssen Wartungs- und Inspektionsarbeiten durchgeführt werden, hat der Besteller diese auf eigene Kosten rechtzeitig auszuführen. Solange das Eigentum noch nicht übergegangen ist, hat der Besteller den Lieferanten unverzüglich schriftlich zu benachrichtigen, wenn der gelieferte Gegenstand gepfändet oder sonstigen Eingriffen Dritter ausgesetzt ist.

7. Der Besteller ist während der Dauer des Eigentumsvorbehalts nicht berechtigt den Liefergegenstand zu verpfänden oder zur Sicherung zu übereignen.

XV. Allgemeine Bestimmungen

1. Stellt ein Vertragspartner seine Zahlungen ein oder wird das Insolvenzverfahren über sein Vermögen oder ein außergerichtliches Vergleichsverfahren beantragt, so ist der andere berechtigt, für den nicht erfüllten Teil vom Vertrag zurückzutreten.

2. Sollte eine Bestimmung dieser Bedingungen und etwaiger weiterer getroffener Vereinbarungen unwirksam sein oder werden, so wird dadurch die Gültigkeit des Vertrages im Übrigen nicht berührt. Die Vertragspartner sind verpflichtet, die unwirksame Bestimmung durch eine ihr im wirtschaftlichen Erfolg möglichst gleichkommende Regelung zu ersetzen.

3. Es gilt ausschließlich das Recht der Bundesrepublik Deutschland unter Ausschluss des UN-Kaufrechts (CISG).

4. Der Erfüllungsort richtet sich nach den gesetzlichen Bestimmungen. Abweichende Vereinbarungen können nur individualvertraglich getroffen werden und bedürfen der Schriftform.

5. Gerichtsstand für sämtliche gerichtlichen Verfahren, ist Remscheid, sofern der Besteller Kaufmann, juristische Person des öffentlichen Rechts oder öffentlich-rechtliches Sondervermögen ist. Dem Lieferanten steht das Recht zu, den Besteller nach seiner Wahl auch an dessen allgemeinem Gerichtsstand oder einem sonstigen eröffneten Gerichtsstand in Anspruch zu nehmen.



Divisions of

DÖNGES

Dönges GmbH & Co. KG
Jägerwald 11

D-42897 Remscheid

Fon +49 (0) 21 91/56 26-0

Fax +49 (0) 21 91/56 26-199

info@doenges-rs.de

www.doenges-rs.de

© 2015 Dönges, Remscheid