

JBC

www.jbctools.com

INSTRUCTION MANUAL



CDEB

Soldering-Assistant Station

This manual corresponds to the following references:

CDE-9BQA (100V)

CDE-1BQA (120V)

CDE-2BQA (230V)

Packing List

The following items are included:



Control Unit 1 unit



General Purpose Handle 1 unit
Ref. T245-A



Power Cord 1 unit
Ref. 0024092 (100V)
0023715 (120V)
0023714 (230V)

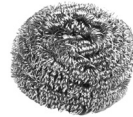

Brass Wool..... 1 unit
Ref. CL6210



Sponge 1 unit
Ref. S0354

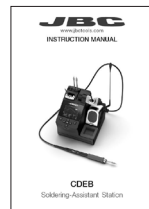

Manual 1 unit
Ref. 0026942

Features and Connections

Adjustable Stand:
Intelligent
Heat Management

Cable Collector

Cartridge Storage

Quick Tip Changer

Process Screen

Tip Cleaner Brass Wool
with Antisplash Membrane
and Wiper

USB-A Connector

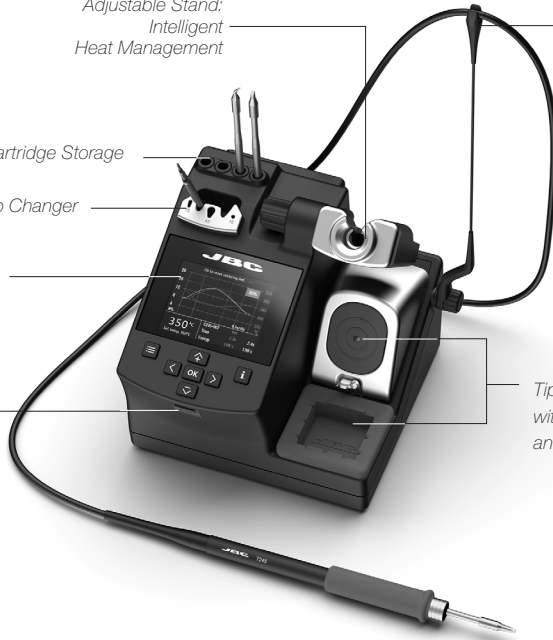

**General Purpose
Handle**
Ref. T245-A

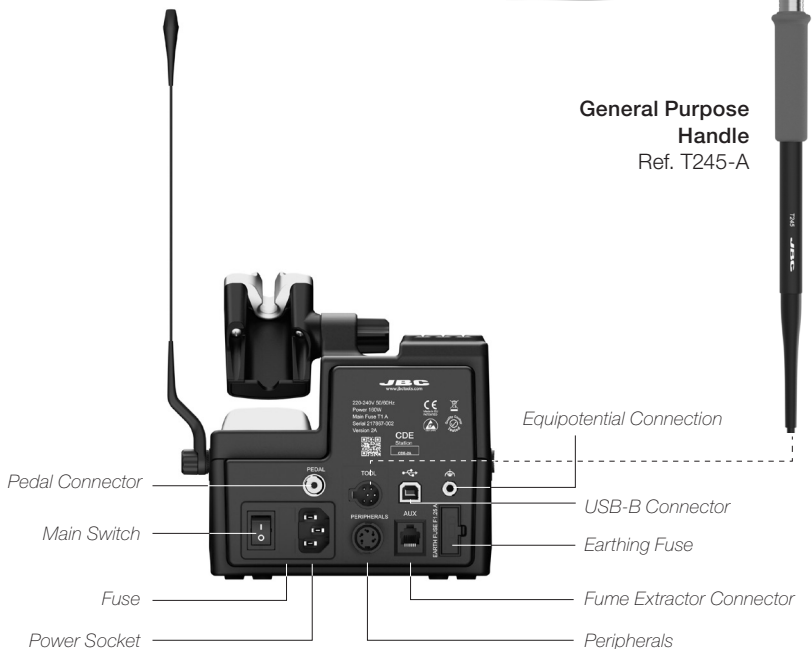



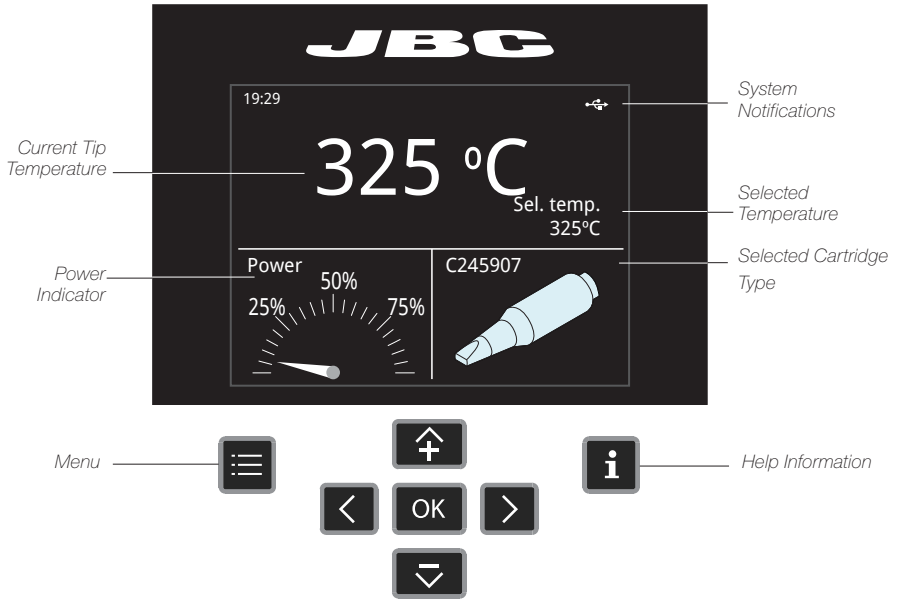

CDEB Work Screen

The CDE offers an intuitive user interface which provides quick access to station parameters.

Original PIN: 0105



System Notifications (Status Bar)

-  USB flash drive is connected.
-  Station is controlled by a PC.
-  Warning. Press INFO for failure description.
-  Station software update. Press INFO to start the process.
-  Error. Press INFO for failure description, the type of error and how to proceed.

Troubleshooting

Station troubleshooting available on the product page at www.jbctools.com

Soldering Assistant

The Soldering Assistant allows to analyze and compare manual soldering processes in real time, obtaining a qualification of the process.

The station compares all new solderings with the reference soldering profile. According to the soldering performed the station gives the user feedback, displaying a color - red or green - along with the percentage of similarity.

Soldering Assistant Main Screen

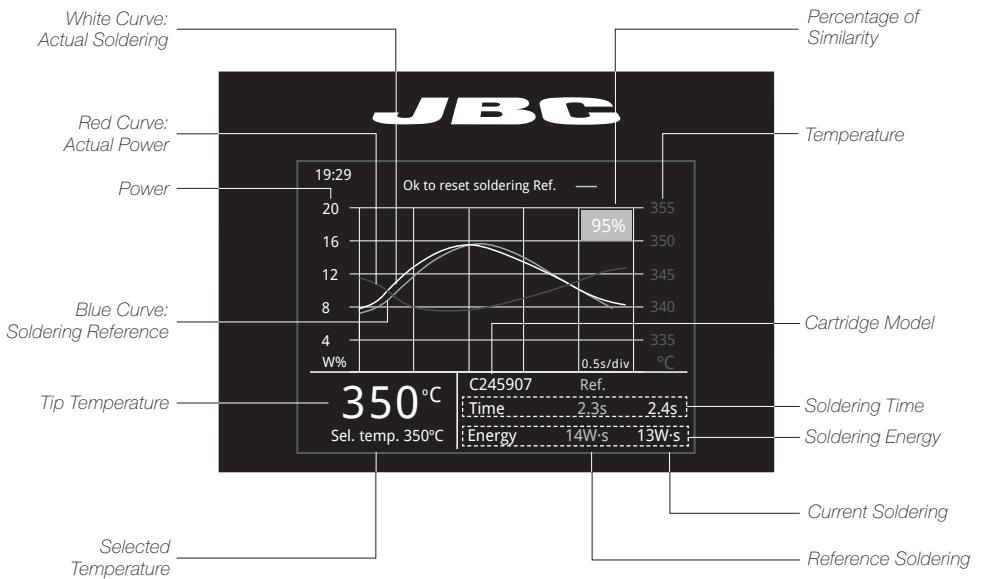

1. Soldering Assistant Activation

Access to station menu by pressing .

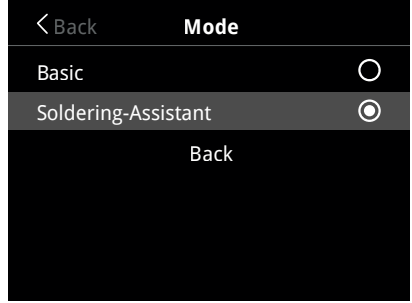
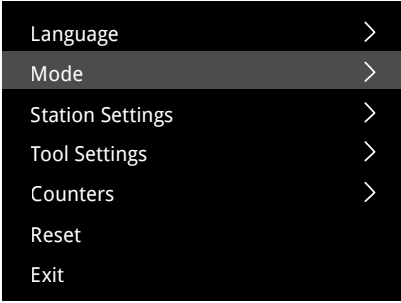

2. Cartridge Selection

Access to station menu by pressing .

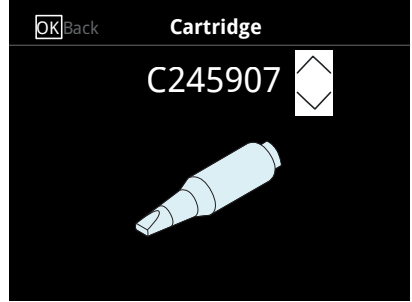
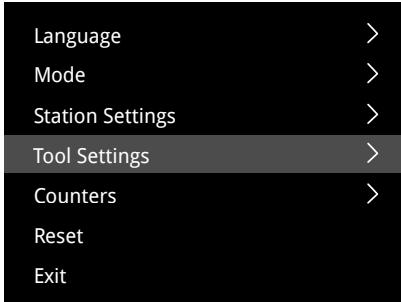

3. Work Temperature Selection

Change temperature (from 90 to 450°C). Use  and  buttons.

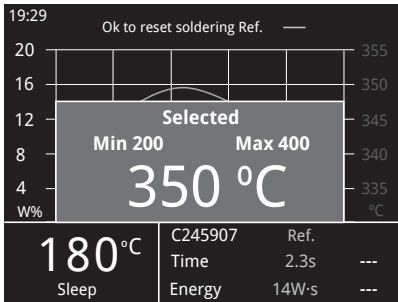

4. Acceptance Limits Setting

The JBCs default percentage is: 0-60% 61-100%

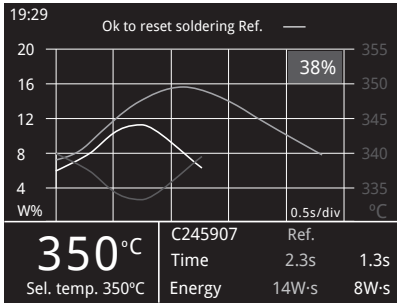

Red percentage:

Less energy was applied (white curve) than the reference (blue curve), therefore less time. The result could be a solder joint with few tin, not evenly distributed or a cold solder joint.

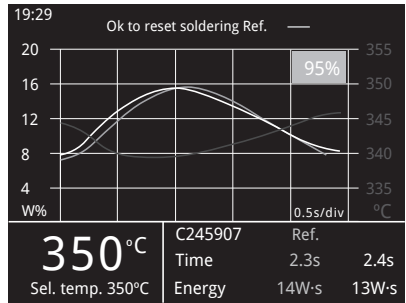

Green percentage:

There is a huge similarity between two solder joints (white and blue curves) and the amount of provided energy.

Note: To modify acceptance limits access to station menu: General Settings/Red Limits.

5. Soldering Reference Setup

When the calibration is finished, perform a soldering joint and press **OK** to set up the reference.

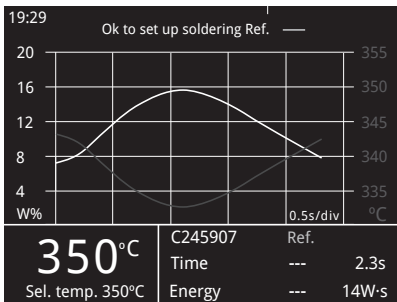

White: last soldering

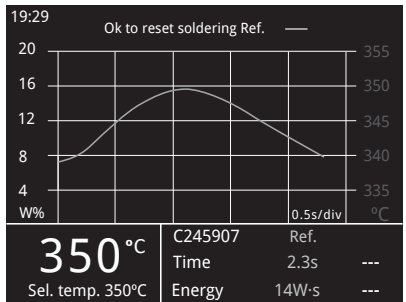

Blue: reference soldering

6. Working With Soldering Assistant

Perform solderings and the station will compare them with the soldering reference.

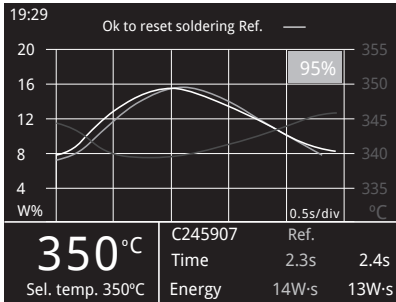

7. Soldering Joint Information Screen

By pressing the **i** access to the detailed parameters for each solder joint.

With **<** and **>** you can select the curve comparison of the last five solder joints.

SOLDERING JOINT INFO			1/3
	Last	Ref.	Diff.
Sel. temp.	350°C	350°C	
Cartridge	C245907	C245907	
Time	2.4s	2.3s	-2%
Max temp	350°C	350°C	+0%
Min temp	335°C	340°C	-1%
Energy	13W·s	14W·s	+29%
Result	95%		

Operation

The JBC Most Efficient Soldering System

This revolutionary technology is able to recover tip temperature extremely quickly. This allows the user to work at a lower temperature. As a result, tip life increases by 5.

1. Work

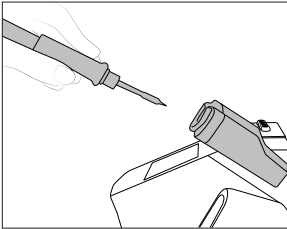

When the tool is lifted from the stand the tip will heat up to the selected temperature.

2. Sleep

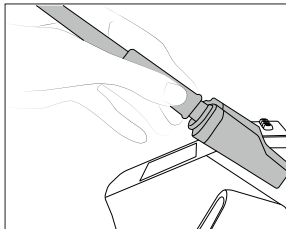

When the tool is in the stand, the temperature falls to the preset sleep temperature.

3. Hibernation

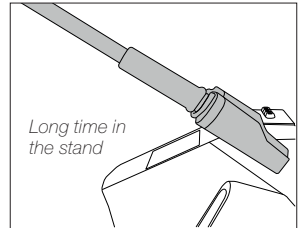

After longer periods of inactivity, the power is cut off and the tool cools down to room temperature.

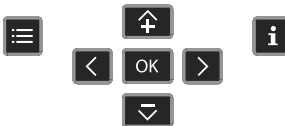
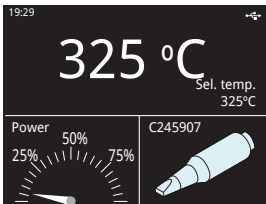

- Change temperature (from 90 to 450°C)
- $\wedge \vee$ Steps ± 5

- Through menu settings:
- Select temperature levels
 - Fix one temperature

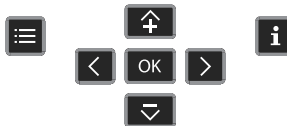
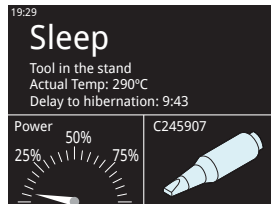

- Through menu settings:
- Change Sleep temperature
 - Set Sleep delay (from 0 to 9 min or no Sleep)

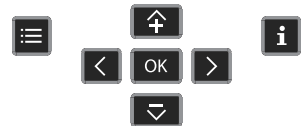
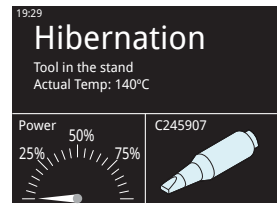

- Through menu settings:
- Change Hibernation delay (from 0 to 35 min)

Quick Tip Changer

Save time and change cartridges safely without switching the station off.

1. Removing

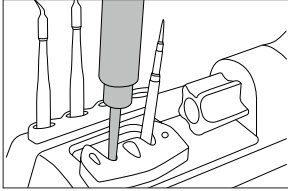

Place the handpiece in the extractor and pull to remove the cartridge.

2. Inserting

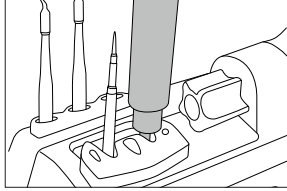

Place the handpiece on top of the new cartridge and press down slightly.

3. Fixing

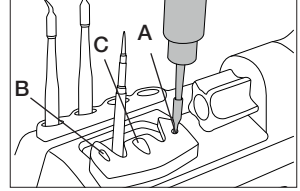

Use the holes for fixing the cartridge* as follows:

- A.** For straight C210.
- B.** For curved C210.
- C.** For C245.

***Important:** It is essential to insert the cartridges as far as the mark for a proper connection.



Compatible Cartridges

The CDEB stations work with C245 cartridges and T245 handles.
Find the model that best suits your soldering needs in www.jbctools.com



Conical



Chisel



Conical Bent



Bevel

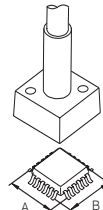

Special Models

Changing the Grips

Replace the grips easily using the slip-on tabs. **Note:** Choose the correct grip depending on your handle model.

Handle ref.: T245-A / T245-C / T245-GA		T210-A / T210-NA		T245-PA		T210-PA
Grip ref.: 0016057 (green)		0018658 (green)		0021528 (blue)		0023310 (blue)

1. Inserting Tabs

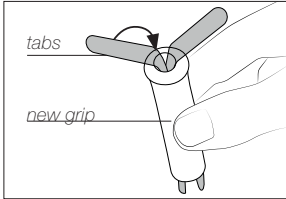

Put the slide-on tabs into the new grip.

2. Inserting Handle

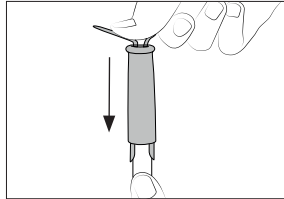

Push the grip with the tabs onto the handle.

3. Removing Tabs

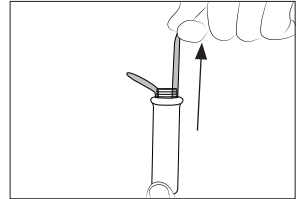

Hold the grip and pull the tab. Use pliers if necessary.

Sealing Plug Replacement

The sealing plug prevents undesirable flux vapors or particles from entering inside the tool. Its usage is highly recommended for intensive applications when soldering is exposed to FOD environments or for applications where the soldering iron works close to vertical position. **Note:** Choose the correct sealing plug depending on your handle model.

Handle ref: T245 / T470		T210
Sealing plug ref.: OB2000		OB1000

⚠ Before replacing the sealing plug, unplug the power supply and make sure the device is not hot.

1. Removing Sealing Plug

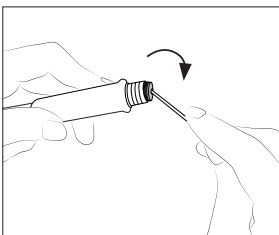

Enter, not deeper than 8mm, a small shaft or screwdriver, lift and pull the sealing plug. Never use a cartridge to do this operation.

2. Mounting Position

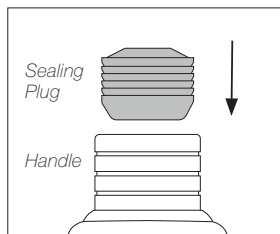

Note: The chamfered side has to be positioned towards the handle.

3. Inserting Sealing Plug

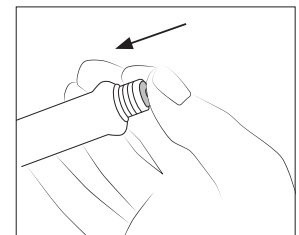

Push the sealing plug inside the handle until the sealing plug and handle edges are aligned.

Adjustable Stand

Adjust the tool stand to suit your work position.

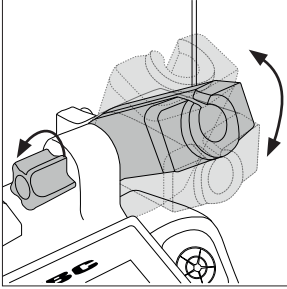

Cable Collector (Ref. CC1001)

The cable collector keeps the cable away from the work area and prevents that the weight of the cable from disturbing the operator while soldering.

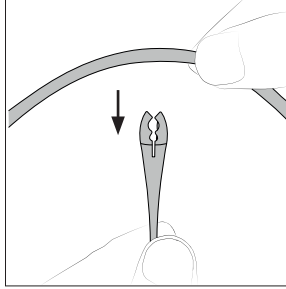

Insert the cable into the clip and then insert into the cable collector. Do not leave the cable longer than necessary to reach the work area freely.

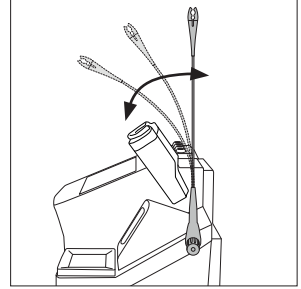

The cable collector is flexible. It accompanies and adapts to the movements during the soldering process.

Tip Cleaner

Select the option to suit your needs and improve the thermal transfer of the tip.

Splashguard

Ref. 0017576

When using the brass wool, it prevents splashing of solder particles.

Antisplash Membrane

Ref. CL7882

Prevents splashing and keeps the work area clean.

Brass Wool

Ref. CL6210

Very effective cleaning method. Leaves a small layer of solder on the tip preventing oxidation between cleaning and reflowing.

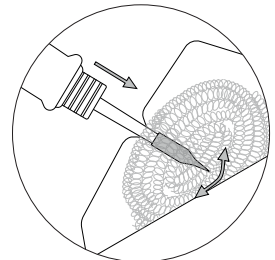
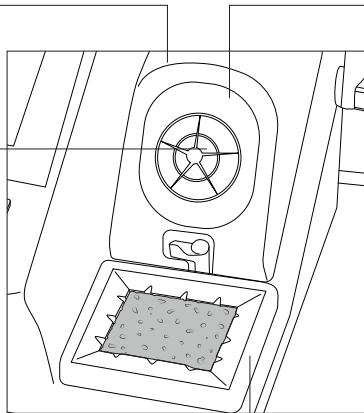

If the tip is very dirty, JBC recommends first cleaning it with the wiper to remove excess solder.

Wiper

Ref. CL7984

A temperature resistant receptacle for removing excess solder by gently tapping or wiping.

Removing the Splashguard

1. Unlock the splashguard.

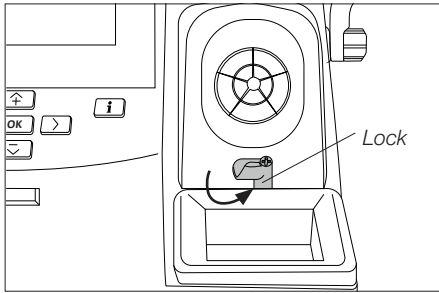

2. Lift off.

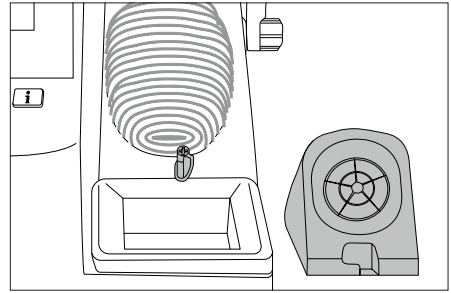

More cleaning options (not supplied):

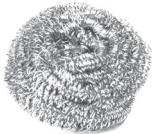

Inox Wool

Ref. CL6205
Stronger cleaning method than brass wool.

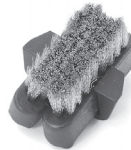

Metal Brush

Ref. CL6220
When used carefully, it provides a more thorough cleaning.

Wiper

Ref. CL7984

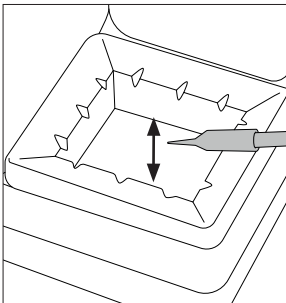

Tapping:

Tap gently to remove excess solder.

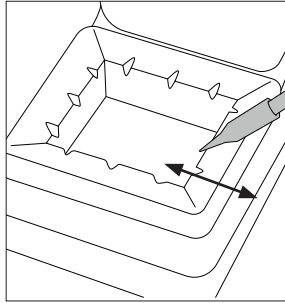

Wiping:

Use the slots to remove remaining particles.

Sponge

Ref. S0354

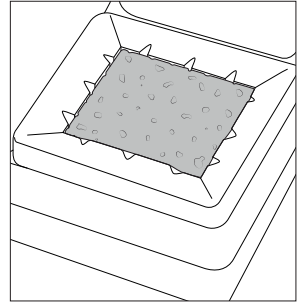

The softest cleaning method. Keep the sponge damp with distilled water when working to avoid tip wear.

Menu Settings

The menu  gives access to the following menu entries:

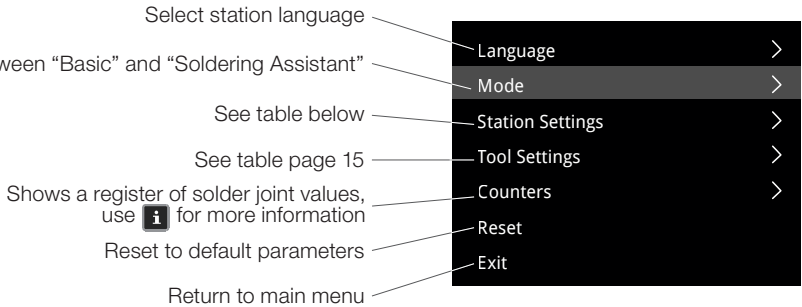

Parameters

Be careful when changing these parameters as they may reduce the tip life if not used properly. Please follow the recommended guidelines:

Station Settings

Parameter Description	Recommendations	Warnings
<p>Program Version Shows the program version number.</p>		
<p>Maximum Temperature Set the maximum temperature to work with. Max. temp by default is 400°C (750°F). This is considered high enough to work with most lead-free applications.</p>	<p>The station temperature range is 90-450°C (190-840°F). Change the temperature limits when working with less common applications such as low / high melting point soldering (HMP) or plastics (e. g. riveting).</p>	<p> In most cases, working with temperatures over 400°C (750°F) can damage the PCB and its components. Even in short time periods of tip contact with the soldering joint, the flux may not work properly and could seriously reduce tip life. If the solder joint requires more power (e.g. multilayered or high dissipation boards), JBC strongly recommends to use preheaters.</p>
<p>Minimum Temperature Set the minimum temperature to work with. Min. temp. by default is 200°C (392°F). This is considered to be a proper starting point for leaded applications.</p>		



Station Settings

Parameter Description	Recommendations	Warnings
<p>PIN Change the default security PIN number (0105).</p>	The PIN must be entered every time a parameter is changed.	
<p>Sound Enable/disable the beep sound of the keypad.</p>		
<p>Temp Units Celsius (°C) or Fahrenheit (°F)</p>		
<p>Date & Time Set the Date and the Time.</p>		

Tool Settings

Parameter Description	Recommendations	Warnings
<p>Cartridge Select the cartridge.</p>		
<p>Temp Adjust It provides a more precise adjustment between the selected temperature and the current one.</p>	Set values within $\pm 50^{\circ}\text{C}$ ($\pm 90^{\circ}\text{F}$) to achieve zero deviation. JBC strongly recommends the use of TID-A or TIA-A Thermometers to obtain precise readings.	<p> When the user changes the cartridge type, the parameter should be reset to 0°C/F or to the value needed for this cartridge. E.g. If a correction of +20°C (+36°F) is set for the C245966 (thick type) and then the user changes the cartridge for a C245030 (which is thinner) without resetting, they would be working at a temperature of +20°C (+36°F) lower for the C245030 which does not need any temperature adjustment.</p>

Tool Settings

Parameter Description	Recommendations	Warnings
Temp Level Set The user can set up to 3 different temperatures.	Switch between 3 different levels by just one “click”. Set them according to the allowed values for your soldering applications.	
Sleep Delay Set the time that the tool will remain at the selected temperature when in the stand before entering sleep mode. The tip temperature will then drop to the Sleep temperature.	Because our tools reach the working temperature from the default Sleep mode in only a few seconds, this parameter is preset to 0 min. Once the tool is returned to the stand the temperature will automatically drop to the sleep temperature, extending tip life and avoiding oxidation. Retinning the tip before placing the tool in the stand will protect the tip and extend its life.	 Setting these parameters to higher values will unnecessarily accelerate oxidation and shorten tip life especially when working.
Sleep Temp This is the set temperature the tip reaches when returned to the stand.	The sleep temperatures are set to achieve a balance between preventing oxidation and reaching the working temperature in a few seconds.	
Hibernation Delay Set the time the tool will remain at Sleep temperature before entering the Hibernation mode. At this time, the power supply is cut off and the tip remains at room temperature.	This function completely protects the tip from oxidation during long periods of inactivity while the tool is in the stand. Retinning the tip before placing the tool in the stand also helps prevent oxidation and extends the life of the tip.	 Increasing the default value will accelerate oxidation and shorten the tip life.
Peripherals Link connected peripherals		

USB Connectors

Download the latest software from our website to improve your soldering station.

Station Update



Update

Download the JBC Update File from www.jbctools.com/software.html

Insert the USB flash drive with the file downloaded to the station.

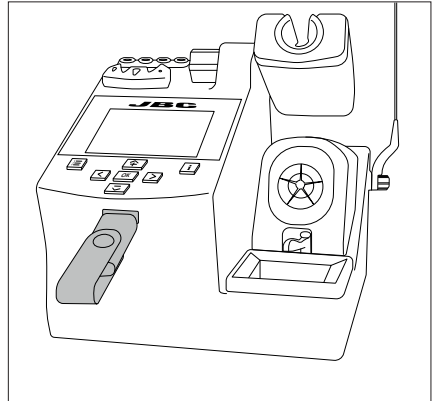

JBC Web Manager

www.jbctools.com/manager.html

Manage and monitor as many stations as your PC can handle by using the JBC Web Manager. You can export data to another PC.

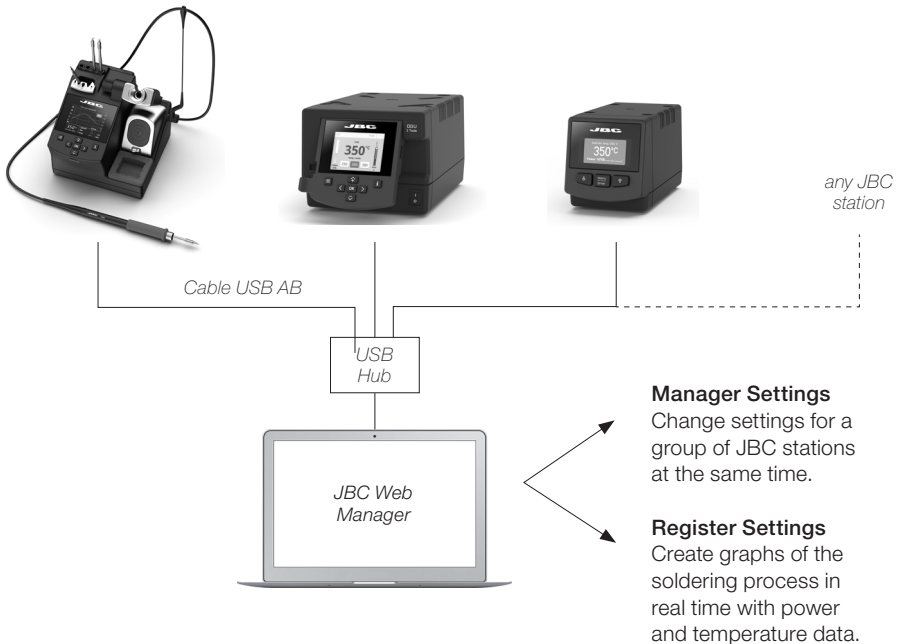

Maintenance

Before carrying out maintenance, always switch the device off and disconnect it from the mains. Allow the equipment to cool down.

- Clean the station screen with a glass cleaner or a damp cloth.
- Use a damp cloth to clean the casing and the tool. Alcohol can only be used to clean the metal parts.
- Periodically check that the metal parts of the tool and stand are clean so that the station can detect the tool status.
- Maintain tip surface clean and tinned prior to storage in order to avoid tip oxidation. Rusty and dirty surfaces reduce heat transfer to the solder joint.

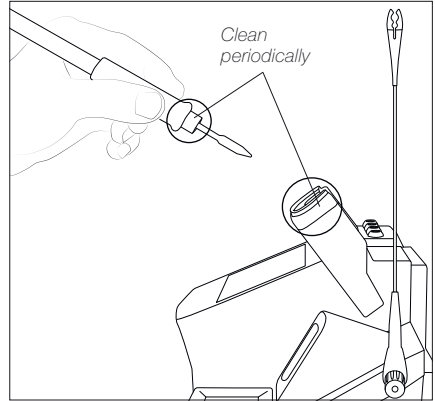

- Periodically check all cables and tubes.
- Replace any defective or damaged pieces. Only use original JBC spare parts.
- Replace a blown fuse as follows:

1. Pull off the fuse holder and remove the fuse. If necessary use a tool to lever it off.
2. Insert the new fuse into the fuse holder and return it to the station.

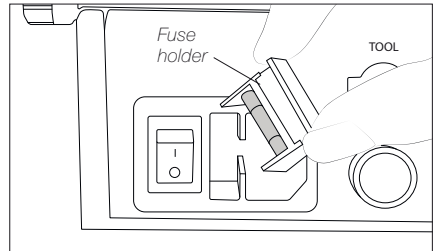

-  When this warning appears on the main screen Earthing Fuse must be replaced

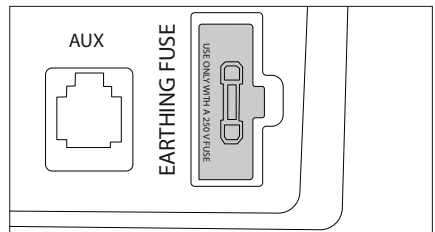

- Repairs should only be performed by a JBC authorized technical service.

Safety



It is imperative to follow safety guidelines to prevent electric shock, injury, fire or explosion.

- Do not use the units for any purpose other than soldering or rework. Incorrect use may cause fire.
- The power cable must be plugged into approved bases. Make sure that it is properly grounded before use. When unplugging it, hold the plug, not the wire.
- Do not work on electrically live parts.
- The tool should be placed in the stand when not in use in order to activate the sleep mode. The soldering tip, the metal part of the tool and the stand may still be hot after the station is turned off. Handle with care, including when adjusting the stand position.
- Do not leave the appliance unattended when it is on.
- Do not cover the ventilation grills. Heat can cause inflammable products to ignite.
- Avoid flux coming into contact with skin or eyes to prevent irritation.
- Be careful with the fumes produced when soldering.
- Keep your workplace clean and tidy. Wear appropriate protection glasses and gloves when working off to avoid personal harm.
- Utmost care must be taken with liquid tin waste which can cause burns.
- This appliance can be used by children over the age of eight as well as persons with reduced physical, sensory or mental capabilities or lacking experience provided that they have been given adequate supervision or instruction concerning use of the appliance and understand the hazards involved. Children must not play with the appliance.
- Maintenance must not be carried out by children unless supervised.

Specifications

CDEB

Soldering-Assistant Station

Ref.: **CDE-9BQA** 100V 50/60Hz. Input fuse: T2A. Earthing fuse: F1.25 A. Output: 23.5V.

Ref.: **CDE-1BQA** 120V 50/60Hz. Input fuse: T2A. Earthing fuse: F1.25 A. Output: 23.5V.

Ref.: **CDE-2BQA** 230V 50/60Hz. Input fuse: T1A. Earthing fuse: F1.25 A. Output: 23.5V.

- Output Peak Power CDE-BA: 130W
- Temperature Range: 90 - 450 °C / 190 - 840 °F
- Idle Temp. Stability (still air): $\pm 1.5^{\circ}\text{C}$ / $\pm 3^{\circ}\text{F}$ (Meets and exceed IPC J-STD-001)
- Temp. Accuracy: $\pm 3\%$ (Using reference cartridge)
- Temp. Adjustment: $\pm 50^{\circ}\text{C}$ / $\pm 90^{\circ}\text{F}$ (Through station menu settings)
- Tip to Ground Voltage/Resistance: Meets and exceed
ANSI/ESD S20.20-2014 IPC J-STD-001F
- Earthing Fuse: F 1.25A
- Connections: USB-A Uptade and files import-export
USB-B Connection Station-PC
RJ12 Connector
- Ambient Operating Temp: 10 - 50 °C / 50 - 122 °F
- Control Unit Dimensions / Weight: 170 x 176 x 145 mm / 2.8 kg
(L x W x H) 6.7 x 6.9 x 5.7 in / 6.17 lb
- Total Net Weight: 2.94 kg / 6.48 lb
- Total Package Dimensions / Weight: 234 x 234 x 258 mm / 3.54 kg
(L x W x H) 9.2 x 9.2 x 10.2 in / 7.80 lb

Complies with CE standards.

ESD protected housing.

JBC

Warranty

JBC's 2 year warranty covers this equipment against all manufacturing defects, including the replacement of defective parts and labour.

Warranty does not cover product wear or misuse.

In order for the warranty to be valid, equipment must be returned, postage paid, to the dealer where it was purchased.

Get 1 extra year JBC warranty by registering here:
<https://www.jbctools.com/productregistration/>
within 30 days of purchase.



This product should not be thrown in the garbage.

In accordance with the European directive 2012/19/EU, electronic equipment at the end of its life must be collected and returned to an authorized recycling facility.

CE EAC UK
CA

www.jbctools.com